

# Unitronics UMI-B7 VFD User Guide



---

<b>No.</b>	<b>Change Description</b>	<b>Version</b>	<b>Date</b>
1	Initial version	V1.4	January 2024
2	Design	V1.5	February 2024
3	Language correction	V1.7	April 2024

# Content

Content.....	iii
1 Safety precautions .....	1
1.1 What this chapter contains .....	1
1.2 Safety definition.....	1
1.3 Warning symbols.....	1
1.4 Safety guidelines.....	2
1.4.1 Delivery and installation.....	2
1.4.2 Commissioning and running.....	3
1.4.3 Maintenance and component replacement.....	4
1.4.4 What to do after scrapping.....	4
2 Quick start .....	5
2.1 What this chapter contains .....	5
2.2 Unpack inspection.....	5
2.3 Application confirmation.....	5
2.4 Environment confirmation.....	5
2.5 Installation confirmation.....	6
2.6 Basic commissioning.....	6
2.7 Safety standard related data.....	7
3 Product overview .....	8
3.1 What this chapter contains .....	8
3.2 Basic principle.....	8
3.3 Product specifications.....	9
3.4 Product nameplate .....	12
3.5 Model code .....	12
3.6 Product ratings.....	13
3.6.1 AC 3PH 200V–240V .....	13
3.6.2 AC 3PH 380V–480V .....	14
3.6.3 AC 3PH 520V–600V .....	15
3.7 Structure diagram.....	16
4 Installation guidelines.....	17
4.1 What this chapter contains .....	17
4.2 Mechanical installation .....	17
4.2.1 Installation environment.....	17
4.2.2 Installation direction.....	18
4.2.3 Installation mode .....	19
4.2.4 Single-unit installation.....	19
4.2.5 Multiple-unit installation.....	20
4.2.6 Vertical installation.....	21
4.2.7 Tilted installation.....	22

4.3 Standard wiring of main circuit.....	23
4.3.1 Wiring diagram of main circuit.....	23
4.3.2 Main circuit terminal diagram .....	24
4.3.3 Wiring process of the main circuit terminals .....	29
4.4 Standard wiring of control circuit.....	30
4.4.1 Wiring diagram of basic control circuit.....	30
4.4.2 Input/output signal connection diagram .....	32
4.5 Wiring protection .....	33
4.5.1 Protecting the VFD and input power cable in short circuit.....	33
4.5.2 Protecting the motor and motor cable in short circuit .....	34
4.5.3 Protecting the motor and preventing thermal overload.....	34
4.5.4 Bypass connection.....	34
5 Basic operation instructions .....	35
5.1 What this chapter contains .....	35
5.2 Keypad introduction.....	35
5.3 Keypad display.....	39
5.3.1 Displaying stopped-state parameters .....	39
5.3.2 Displaying running-state parameters .....	40
5.3.3 Displaying fault information .....	41
5.4 Operating the VFD through the keypad.....	41
5.4.1 Entering/exiting menus .....	41
5.4.2 Editing a parameter list .....	46
5.4.3 Adding parameters to the parameter list displayed in stopped/running state .....	47
5.4.4 Adding parameters to the user defined parameter list.....	47
5.4.5 Editing user defined parameters .....	48
5.4.6 Editing parameters in parameter groups .....	49
5.4.7 Monitoring states .....	49
5.4.8 Autotuning motor parameters .....	50
5.4.9 Backing up parameters .....	50
5.4.10 System settings .....	51
5.4.11 Power-on setup wizard.....	51
5.5 Basic operation instruction.....	53
5.5.1 What this section contains .....	53
5.5.2 Common commissioning procedure .....	53
5.5.3 Vector control .....	57
5.5.4 SVPWM control mode.....	62
5.5.5 Torque control.....	71
5.5.6 Motor parameter .....	75
5.5.7 Start/stop control .....	80
5.5.8 Frequency setting .....	87
5.5.9 Analog input.....	91

5.5.10 Analog output.....	94
5.5.11 Digital input.....	99
5.5.12 Digital output .....	108
5.5.13 Simple PLC .....	113
5.5.14 Multi-step speed running.....	116
5.5.15 PID control.....	118
5.5.16 Run at wobbling frequency.....	123
5.5.17 Local encoder input .....	124
5.5.18 Commissioning procedures for closed-loop control, position control and spindle positioning.....	125
5.5.19 Fault handling .....	131
5.5.20 Tension control solutions.....	136
6 Function parameter list.....	141
6.1 What this chapter contains .....	141
6.2 Function parameter list.....	141
P00 group—Basic functions.....	142
P01 group—Start/stop control.....	146
P02 group—Parameters of motor 1 .....	151
P03 group—Vector control of motor 1 .....	155
P04 group—V/F control .....	164
P05 group—Input terminals .....	172
P06 group—Output terminals .....	181
P07 group—HMI .....	186
P08 group—Enhanced functions .....	193
P09 group—PID control.....	203
P10 group—Simple PLC and multi-step speed control .....	208
P11 group—Protection parameters .....	211
P12 group—Parameters of motor 2 .....	219
P13 group—Control parameters of synchronous motor.....	223
P14 group—Serial communication function.....	225
P15 group—Functions of communication expansion card 1 .....	229
P16 group—Functions of communication expansion card 2 .....	232
P17 group—Status viewing .....	239
P18 group—Closed-loop control state check .....	245
P19 group—Expansion card state check .....	248
P20 group—Encoder of motor 1 .....	250
P21 group—Position control .....	254
P22 group—Spindle positioning.....	260
P23 group—Vector control of motor 2 .....	263
P24 group—Encoder of motor 2 .....	265
P25 group—Extension I/O card input functions .....	269

P26 group—Output functions of expansion I/O card.....	272
P27 group—Programmable expansion card functions.....	275
P28 group—Master/slave control functions.....	278
P90 group—Tension control in speed mode.....	281
P91 group—Tension control in torque mode.....	285
P92 group—Customized tension control functions.....	288
P93 group—Tension control status viewing.....	290
7 Troubleshooting.....	293
7.1 What this chapter contains.....	293
7.2 Indications of alarms and faults.....	293
7.3 Fault reset.....	293
7.4 Fault history.....	293
7.5 VFD faults and solutions.....	293
7.5.1 Details of faults and solutions.....	293
7.5.2 Other state.....	301
7.6 Analysis on common faults.....	301
7.6.1 Motor fails to work.....	301
7.6.2 Motor vibrates.....	302
7.6.3 Overvoltage.....	303
7.6.4 Undervoltage.....	303
7.6.5 Unusual heating of motor.....	304
7.6.6 VFD overheating.....	305
7.6.7 Motor stalls during ACC.....	306
7.6.8 Overcurrent.....	307
7.7 Countermeasures on common interference.....	308
7.7.1 Interference on meter switches and sensors.....	308
7.7.2 Interference on communication.....	309
7.7.3 Failure to stop and indicator shimmering due to motor cable coupling.....	310
7.7.4 Leakage current and interference on RCD.....	310
7.7.5 Live device chassis.....	311
8 Maintenance.....	312
8.1 What this chapter contains.....	312
8.2 Periodical inspection.....	312
8.3 Cooling fan.....	314
8.4 Capacitor.....	315
8.4.1 Capacitor reforming.....	315
8.4.2 Electrolytic capacitor replacement.....	316
8.5 Power cable.....	316
9 Communication protocol.....	318
9.1 What this chapter contains.....	318
9.2 Modbus protocol introduction.....	318

9.3 Application of Modbus .....	318
9.3.1 RS485 .....	318
9.3.2 RTU mode .....	321
9.4 RTU command code and communication data .....	324
9.4.1 Command code: 03H, reading N words (continuously reading a maximum of 16 words) .....	324
9.4.2 Command code: 06H, writing a word .....	326
9.4.3 Command code: 10H, continuous writing .....	327
9.4.4 Data address definition .....	327
9.4.5 Fieldbus scale .....	331
9.4.6 Error message response .....	332
9.4.7 Read/Write operation example .....	334
9.5 Common communication faults .....	339
Appendix A Expansion cards .....	340
A.1 Dimensions and installation .....	340
A.2 Wiring .....	343
A.3 IO cards .....	343
A.3.1 IO Card (UMI-S0170) .....	343
A.4 Communication cards .....	346
A.4.1 CANopen communication card (UMI-S0006) .....	346
A.4.2 Ethernet/IP communication card (UMI-S0007) and Modbus TCP communication card (UMI-S0009) .....	347
A.4.3 EtherCAT communication card (UMI-S0008) .....	349
A.5 PG cards .....	352
A.5.1 Sin/Cos PG card (UMI-S0014) .....	352
A.5.2 Resolver PG card (UMI-S0013) .....	354
A.5.3 Multifunction incremental PG card (UMI-S0011) .....	356
A.5.4 24V incremental PG card (UMI-S0010) .....	359
Appendix B Technical data .....	362
B.1 What this chapter contains .....	362
B.2 Derated application .....	362
B.2.1 Capacity .....	362
B.2.2 Derating .....	362
B.3 Motor connection data .....	365
B.3.1 EMC compatibility and motor cable length .....	365
Appendix C Dimensions .....	366
C.1 What this chapter contains .....	366
C.2 Keypad structure .....	366
C.2.1 Structure diagram .....	366
C.2.2 Keypad installation bracket .....	366
C.3 VFD structure .....	367

---

C.4 Dimensions of VFDs of AC 3PH 200V–240V and 380V–480V .....	367
C.4.1 Wall installation dimensions.....	367
C.4.2 Flange installation dimensions.....	370
C.4.3 Floor installation dimensions .....	372
C.5 Dimensions of VFDs of AC 3PH 520V–600V .....	373
C.5.1 Wall installation dimensions.....	373
C.5.2 Flange installation dimensions.....	375
Appendix D Optional peripheral accessories .....	377
D.1 What this chapter contains.....	377
D.2 Wiring of peripheral accessories .....	377
D.3 Power supply.....	378
D.4 Cables.....	378
D.4.1 Power cables .....	378
D.4.2 Control cables.....	379
D.4.3 Cable arrangement .....	382
D.4.4 Insulation inspection.....	383
D.5 Breaker and electromagnetic contactor .....	383
D.6 Reactors.....	385
D.7 Filters .....	387
D.8 Brake system.....	387
D.8.1 Braking component selection.....	387
D.8.2 Braking resistor cable selection .....	390
D.8.3 Braking resistor installation.....	390
Appendix E STO function description .....	392
E.1 STO function logic table .....	392
E.2 STO channel delay description.....	392
E.3 STO function installation checklist.....	393
Appendix F Acronyms and abbreviations.....	394
Appendix G Energy efficiency data.....	395



# 1 Safety precautions

## 1.1 What this chapter contains

Read this manual carefully and follow all safety precautions before moving, installing, operating and servicing the variable-frequency drive (VFD). If these safety precautions are ignored, physical injury or death may occur, or damage may occur to the equipment.

If any physical injury or death or damage to the equipment occur due to neglect of the safety precautions in the manual, our company will not be responsible for any damages and we are not legally bound in any manner.

## 1.2 Safety definition

**Danger:** Serious physical injury or even death may occur if related requirements are not followed.











**Warning:** Physical injury or damage to the equipment may occur if related requirements are not followed.



**Note:** Procedures taken to ensure proper operation.

**Qualified electricians:** People working on the device should take part in professional electrical and safety training, receive the certification and be familiar with all steps and requirements of installing, commissioning, operating and maintaining the device to prevent any emergencies.

## 1.3 Warning symbols

Warnings caution you about conditions which can result in serious injury or death and/or damage to the equipment, and advice on how to avoid the danger. Following warning symbols are used in this manual.

Symbol	Name	Instruction	Abbreviation
 Danger	Danger	Serious physical injury or even death may occur if related requirements are not followed	
 Warning	Warning	Physical injury or damage to the equipment may occur if related requirements are not followed	
 Forbid	Electrostatic discharge	Damage to the PCBA board may occur if related requirements are not followed	
 Hot	Hot sides	The base of the VFD may become hot. Do not touch.	
 5 min	Electric shock	As high voltage still presents in the bus capacitor after power off, wait for at least five minutes (or 15 min / 25 min, depending on the warning symbols on the machine) after	 5 min

Symbol	Name	Instruction	Abbreviation
		power off to prevent electric shock	
	Read manual	Read the operation manual before operating on the equipment	
<b>Note</b>	Note	Procedures taken to ensure proper operation	<b>Note</b>

### 1.4 Safety guidelines

	<ul style="list-style-type: none"> <li>◇ Only trained and qualified electricians are allowed to carry out related operations.</li> <li>◇ Do not perform wiring, inspection or component replacement when power supply is applied. Ensure all the input power supplies are disconnected before wiring and inspection, and wait for at least the time designated on the VFD or until the DC bus voltage is less than 36V. The minimum waiting time is listed in the table below.</li> </ul>																
	<table border="1"> <thead> <tr> <th colspan="2">VFD model</th> <th>Min. waiting time</th> </tr> </thead> <tbody> <tr> <td>220V</td> <td>0.75–55kW</td> <td>5 minutes</td> </tr> <tr> <td rowspan="3">460V</td> <td>1.5kW–110kW</td> <td>5 minutes</td> </tr> <tr> <td>132–315kW</td> <td>15 minutes</td> </tr> <tr> <td>350–500kW</td> <td>25 minutes</td> </tr> <tr> <td>575V</td> <td>0.75kW–110kW</td> <td>5 minutes</td> </tr> </tbody> </table>	VFD model		Min. waiting time	220V	0.75–55kW	5 minutes	460V	1.5kW–110kW	5 minutes	132–315kW	15 minutes	350–500kW	25 minutes	575V	0.75kW–110kW	5 minutes
	VFD model		Min. waiting time														
	220V	0.75–55kW	5 minutes														
	460V	1.5kW–110kW	5 minutes														
132–315kW		15 minutes															
350–500kW		25 minutes															
575V	0.75kW–110kW	5 minutes															
<ul style="list-style-type: none"> <li>◇ Do not modify the VFD unless authorized; otherwise, fire, electric shock or other injuries may occur.</li> </ul>																	
<ul style="list-style-type: none"> <li>◇ The base of the heat sink may become hot during running. Do not touch to avoid burns.</li> </ul>																	
<ul style="list-style-type: none"> <li>◇ The electrical parts and components inside the VFD are electrostatic. Take measures to prevent electrostatic discharge during related operation.</li> </ul>																	

#### 1.4.1 Delivery and installation

	<ul style="list-style-type: none"> <li>◇ Install the VFD on fire-retardant material and keep the VFD away from combustible materials.</li> <li>◇ Connect the optional braking parts (braking resistors, braking units or feedback units) according to the wiring diagram.</li> <li>◇ Do not operate on a damaged or incomplete VFD.</li> <li>◇ Do not touch the VFD with wet items or body parts; otherwise, electric shock may occur.</li> <li>◇ Solid State motor overload protection reacts when reaches 150% of FLA.</li> </ul>
---	---

**Note:**

- ◇ Select appropriate tools for delivery and installation to ensure a safe and proper running of the VFD and avoid physical injury or death. To ensure physical safety, the installation staff should take

mechanical protective measures like wearing exposure shoes and working uniforms.

- ✧ Ensure to avoid physical shock or vibration during delivery and installation.
- ✧ Do not carry the VFD by its front cover only as the cover may fall off.
- ✧ Installation site should be away from children and other public places.
- ✧ The VFD should be used in proper environment (see section 4.2.1 Installation environment for details).
- ✧ Prevent the screws, cables and other conductive parts from falling into the VFD,
- ✧ As leakage current of the VFD during running may exceed 3.5mA, ground properly and ensure the grounding resistance is less than 10Ω. The conductivity of PE grounding conductor is the same with that of the phase conductor (with the same cross sectional area). For models higher than 30 kW, the cross sectional area of the PE grounding conductor can be slightly less than the recommended area.
- ✧ R, S and T are the power input terminals, and U, V and W are output motor terminals. Connect the input power cables and motor cables properly; otherwise, damage to the VFD may occur.

**1.4.2 Commissioning and running**

	<ul style="list-style-type: none"> <li>✧ Disconnect all power sources applied to the VFD before terminal wiring, and wait for at least the time designated on the VFD after disconnecting the power sources.</li> <li>✧ High voltage presents inside the VFD during running. Do not carry out any operation on the VFD during running except for keypad setting. The control terminals of VFD form extra-low voltage circuits. Therefore, you need to prevent the control terminals from connecting to accessible terminals of other devices.</li> <li>✧ The VFD may start up by itself when P01.21 (restart after power down) is set to 1. Do not get close to the VFD and motor.</li> <li>✧ The VFD cannot be used as "Emergency-stop device".</li> <li>✧ The VFD cannot act as an emergency brake for the motor; it is a must to install mechanical braking device.</li> <li>✧ During driving permanent magnet synchronous motor, besides above-mentioned items, the following work must be done before installation and maintenance.             <ol style="list-style-type: none"> <li>1. Disconnect all the input power sources including main power and control power.</li> <li>2. Ensure the permanent-magnet synchronous motor has been stopped, and the voltage on output end of the VFD is lower than 36V.</li> <li>3. After the permanent-magnet synchronous motor is stopped, wait for at least the time designated on the VFD, and ensure the voltage between "+" and "-" is lower than 36V.</li> <li>4. During operation, it is a must to ensure the permanent-magnet synchronous motor cannot run again by the action of external load; it is recommended to install effective external braking device or disconnect the direct electrical connection between permanent-magnet synchronous motor and the VFD.</li> </ol> </li> </ul>
---	--

**Note:**

- ✧ Do not switch on or switch off input power sources of the VFD frequently.
- ✧ For VFDs that have been stored for a long time, set the capacitance and carry out inspection and pilot run on the VFD before use.
- ✧ Close the front cover before running; otherwise, electric shock may occur.



**1.4.3 Maintenance and component replacement**

	<ul style="list-style-type: none"> <li>✧ Only well-trained and qualified professionals are allowed to perform maintenance, inspection, and component replacement on the VFD.</li> <li>✧ Disconnect all the power sources applied to the VFD before terminal wiring, and wait for at least the time designated on the VFD after disconnecting the power sources.</li> <li>✧ Take measures to prevent screws, cables and other conductive matters from falling into the VFD during maintenance and component replacement.</li> </ul>
---	--

**Note:**

- ✧ Use proper torque to tighten the screws.
- ✧ Keep the VFD and its parts and components away from combustible materials during maintenance and component replacement.
- ✧ Do not carry out insulation voltage-endurance test on the VFD, or measure the control circuits of the VFD with megohmmeter.
- ✧ Take proper anti-static measures on the VFD and its internal parts during maintenance and component replacement.

**1.4.4 What to do after scrapping**

	<ul style="list-style-type: none"> <li>✧ The heavy metals inside the VFD should be treated as industrial effluent.</li> </ul>
	<ul style="list-style-type: none"> <li>✧ When the life cycle ends, the product should enter the recycling system. Dispose of it separately at an appropriate collection point instead of placing it in the normal waste stream.</li> </ul>

## 2 Quick start

### 2.1 What this chapter contains

This chapter introduces the basic principles required during installation commissioning. You can realize quick installation commissioning by following these principles.

### 2.2 Unpack inspection

Check as follows after receiving products.

1. Check whether the packing box is damaged or dampened.
2. Check the model identifier on the exterior surface of the packing box is consistent with the purchased model.
3. Check whether the interior surface of packing box is improper, for example, in wet condition, or whether the enclosure of the VFD is damaged or cracked.
4. Check whether the nameplate of the VFD is consistent with the model identifier on the exterior surface of the packing box.
5. Check whether the accessories (including user's manual, control keypad and expansion card units) inside the packing box are complete.

### 2.3 Application confirmation

Check the following items before operating on the VFD.

1. Verify the load mechanical type to be driven by the VFD, and check whether overload occurred to the VFD during actual application, or whether the VFD power class needs to be enlarged.
2. Check whether the actual running current of load motor is less than rated VFD current.
3. Check whether the control precision required by actual load is the same with the control precision provided by the VFD.
4. Check whether the grid voltage is consistent with rated VFD voltage.
5. Check whether the functions required need an optional expansion card to be realized.

### 2.4 Environment confirmation

Check the following items before use.

1. Check whether the ambient temperature of the VFD during actual application exceeds 40°C, if yes, derate 1% for every additional 1°C (for details, see section B.2.2 Derating). In addition, do not use the VFD when the ambient temperature exceeds 50°C. <b>Note:</b> For cabinet-type VFD, its ambient temperature is the air temperature inside the cabinet.
2. Check whether ambient temperature of the VFD during actual application is below -10°C, if yes, install heating facility. <b>Note:</b> For cabinet-type VFD, its ambient temperature is the air temperature inside the cabinet.

3. Check whether the altitude of the application site exceeds 1000m. If yes, derate 1% for every increase of 100m; when the installation site altitude exceeds 3000m, consult with Unitronics support.
4. Check whether the humidity of application site exceeds 90%. If yes, check whether condensation occurred. If condensation does exist, take additional protective measures.
5. Check whether there is direct sunlight or animal intrusion in the application site, if yes, take additional protective measures.
6. Check whether there is dust, explosive or combustible gases in the application site, if yes, take additional protective measures.

**2.5 Installation confirmation**

After the VFD is installed properly, check the installation condition of the VFD.

1. Check whether the input power cable and current-carrying capacity of the motor cable fulfill actual load requirements.
2. Check whether peripheral accessories (including input reactors, input filters, output reactors, output filters, DC reactors, braking units and braking resistors) of the VFD are of correct type and installed properly; check whether the installation cables fulfill requirements on current-carrying capacity.
3. Check whether the VFD is installed on fire-retardant materials; check whether the hot parts (such as reactors and braking resistors) are kept away from combustible materials.
4. Check whether all the control cables are routed separately with power cables based on EMC requirement.
5. Check whether all the grounding systems are grounded properly according to VFD requirements.
6. Check whether installation spacing of the VFD complies with the requirements in operation manual.
7. Check whether installation mode of the VFD complies with the requirements in operation manual. Vertical installation should be adopted whenever possible.
8. Check whether external connecting terminals of the VFD are firm and tight enough, and whether the moment is up to the requirement.
9. Check whether there are redundant screws, cables or other conductive objects inside the VFD, if yes, take them out.

**2.6 Basic commissioning**

Carry out basic commissioning according to the following procedures before operating on the VFD.

1. Select motor type, set motor parameters and select VFD control mode according to actual motor parameters.
2. Whether autotuning is needed? If possible, disconnect the motor load to carry out dynamic parameter autotuning; if the load cannot be disconnected, perform static autotuning.
3. Adjust the acceleration and deceleration time based on actual working conditions of the load.

- |   |
|---|
| 4. Jogging to carry out device commissioning. Check whether the motor running direction is consistent with the direction required, if no, it is recommended to change the motor running direction by exchanging the motor wiring of any two phases. |
| 5. Set all the control parameters and carry out actual operation.   |

**2.7 Safety standard related data**

IEC/EN 61508 (type A system)							ISO 13849**			
SIL	PFH	HFT	SFF	$\lambda_{du}$	$\lambda_{dd}$	PTI*	PL	CCF	DC	Category
2	$8.73 \times 10^{-10}$	1	71.23%	$1.79 \times 10^{-9}$	0	1 year	d	57	60%	3

\* PTI: proof test interval.

\*\* According to the categorization defined in EN ISO 13849-1.

### 3 Product overview

#### 3.1 What this chapter contains

This chapter mainly introduces the operation principles, product features, layouts, nameplates, and model instructions.

#### 3.2 Basic principle

UMI-B7 series VFD is used to control asynchronous AC induction motor and permanent-magnet synchronous motor. The figure below shows the main circuit diagram of the VFD. The rectifier converts 3PH AC voltage into DC voltage, and the capacitor bank of the intermediate circuit stabilizes the DC voltage. The inverter converts DC voltage into the AC voltage used by AC motor. When the circuit voltage exceeds the maximum limit value, external braking resistor will be connected to intermediate DC circuit to consume the feedback energy.

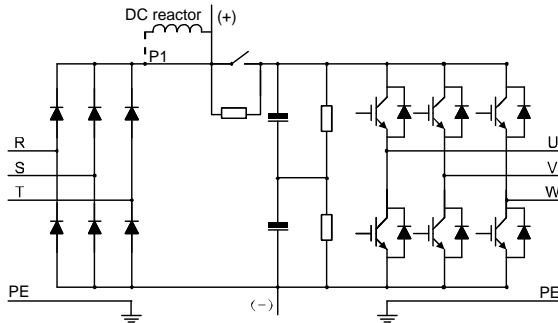

Figure 3-1 Simplified main circuit diagram (VFDs of 220V 18.5–55kW; 460V ≥37kW)

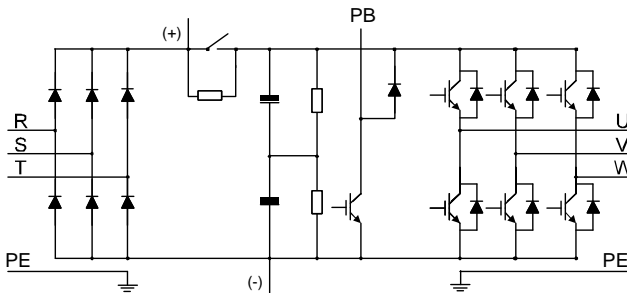

Figure 3-2 Simplified main circuit diagram (VFDs of 220V ≤15kW; 460V ≤30kW)



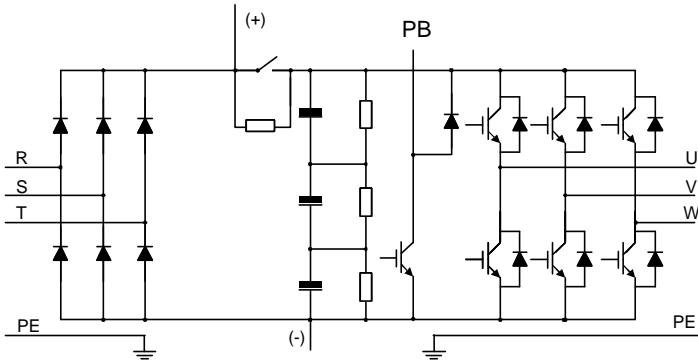

Figure 3-3 Simplified main circuit diagram (VFDs of 575V ≤ 18.5kW)

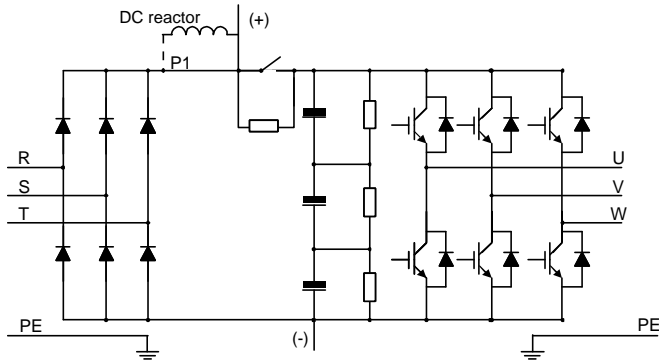

Figure 3-4 Simplified main circuit diagram (VFDs of 575V ≥ 22kW)

**Note:**

- The VFDs of 220V 18.5–55kW, 460V ≥37kW, and 575V ≥22kW support external DC reactors and braking units. DC reactors and braking units are optional.
- The VFDs of 220V ≤15kW, 460V ≤30kW, and 575V ≤18.5kW are equipped with braking units and support external braking resistors and DC reactors which are optional.
- Remove the copper tag between P1 and (+) before connecting an external DC reactor.

**3.3 Product specifications**

Function description		Specification
Power input	Input voltage (V)	AC 3PH 200V–240V Rated voltage: 220V AC 3PH 380V–480V Rated voltage: 460V AC 3PH 520V–600V Rated voltage: 575V
	Allowable voltage fluctuation	-15%–+10%
	Input current (A)	See section 3.6 Product ratings.

Function description		Specification
	Input frequency (Hz)	50Hz or 60Hz, allowable range: 47–63Hz
Power output	Output voltage (V)	0–Input voltage
	Output current (A)	See section 3.6 Product ratings.
	Output power (kW)	See section 3.6 Product ratings.
	Output frequency (Hz)	0–599Hz
Technical control performance	Control mode	Space voltage pulse width modulation (SVPWM), sensorless vector control (SVC), and feedback vector control (FVC)
	Motor type	Asynchronous motor, permanent-magnet synchronous motor
	Speed regulation ratio	Asynchronous motor 1: 200 (SVC); Synchronous motor 1: 20 (SVC), 1:1000 (FVC)
	Speed control precision	±0.2% (SVC); ±0.02% (FVC)
	Speed fluctuation	± 0.3% (SVC)
	Torque response	<20ms SVC); <10ms (FVC)
	Torque control precision	10% (SVC); 5% (FVC)
	Starting torque	Asynchronous motor: 0.25Hz/150% (SVC) Synchronous motor: 2.5 Hz/150% (SVC) 0Hz/200% (FVC)
Overload capacity	150% of the rated current: 1 minute 180% of the rated current: 10 seconds 200% of the rated current: 1 second	
Running control performance	Frequency setting mode	Digital, analog, pulse frequency, multi-step speed running, simple PLC, PID, Modbus communication, and so on The setting combinations and channels can be switched.
	Automatic voltage regulation function	Keeps constant output voltage when grid voltage changes.
	Fault protection function	Provides over 30 fault protection functions: overcurrent, overvoltage, undervoltage, over-temperature, phase loss and overload, and so on.
	Speed tracking restart function	Realizes impact-free starting of the motor in rotating. <b>Note:</b> This function is available for ≥4kW models.
	Retention at transient voltage drop	Keeps running with regenerative energy when the grid transiently drops.
	Motor switchover	Supports two groups of motor parameters to control motor switchover.
	STO	Compliant with SIL2
Peripheral interface	Terminal analog input resolution	No more than 20mV
	Terminal digital input resolution	No more than 2ms
	Analog input	Two inputs. AI1: 0–10V/0–20mA; AI2: -10–10V

Function description		Specification
	Analog output	One output. AO1: 0–10V/0–20mA
	Digital input	Four regular inputs; max. frequency: 1kHz; internal impedance: 3.3kΩ Two high-speed inputs; max. frequency: 50kHz; supports quadrature encoder input; with speed measurement function
	Digital output	One high-speed pulse output; max. frequency: 50kHz One Y terminal open collector output
	Relay output	Two programmable relay outputs RO1A NO, RO1B NC, RO1C common port RO2A NO, RO2B NC, RO2C common port Contact capacity: 3A/AC250V, 1A/DC30V
	Extension interface	Three extension interfaces: SLOT1, SLOT2, SLOT3 (only two are available for VFDs of 220V 0.75kW and 460V 1.5–2.2kW) Supported expansion cards: PG card, programmable card, communication card, I/O card, and so on
Others	Installation mode	Supporting wall-mounting, floor-mounting and flange-mounting
	Temperature of running environment	-10–50°C. Derating is required if the ambient temperature exceeds 40°C. For details about derating, see section B.2.2 Derating.
	Ingress protection rating	IP20
	Pollution level	Level 2
	Cooling mode	Air cooling
	Brake unit	Built-in for VFDs of 220V ≤15kW, 460V ≤30kW, and 575V ≤18.5kW; optional for VFDs of 220V 18.5–55kW, 460V ≥37kW, and 575V ≥22kW
	EMC filter	The VFDs of 460V are configured with built-in C3 filters, meeting the requirements of IEC61800-3 C2.
	Overvoltage category	For input voltage 200–240V: transient surge suppression shall be installed on the line side of this equipment and shall be rated 220V (phase to ground), 220V (phase to phase), suitable for overvoltage category III, and shall provide protection for a rated impulse withstand voltage peak of 4kV. For input voltage 380–480V: transient surge suppression shall be installed on the line side of this equipment and shall be rated 480V (phase to ground), 480V (phase to phase), suitable for overvoltage category III, and shall provide protection for a rated impulse withstand voltage

Function description	Specification
	peak of 6kV. For input voltage 520–600V: transient surge suppression shall be installed on the line side of this equipment and shall be rated 575V (phase to ground), 575V (phase to phase), suitable for overvoltage category III, and shall provide protection for a rated impulse withstand voltage peak of 6kV.

### 3.4 Product nameplate



Figure 3-5 Product nameplate

**Note:**

This is an example of the nameplate of standard UMI-B7 products. The marking such as CE/TUV/IP20 on the top right will be marked according to actual certification conditions.

### 3.5 Model code

The model code contains product information. You can find the model code on the nameplate and simple nameplate of the VFD.

<b>UMI-</b>	<b>XXXX</b>	<b>YY-</b>	<b>B7</b>
1	2	3	4

Figure 3-6 Model code

Field	Sign	Description	Content
Product	①	Abbreviation of product	UMI: Unitronics Motion Inverter
Rated power	②	Rated Power	0022: 2.2 kW 0450: 4.5 kW 1100: 110 kW
Voltage level	③	Voltage level	CU: AC 3PH 200V–240V Rated voltage: 220V EU: AC 3PH 380V–480V Rated voltage: 460V FU: AC 3PH 520V–600V Rated voltage: 575V
Series	④	Abbreviation of product series	B7

### 3.6 Product ratings

#### 3.6.1 AC 3PH 200V–240V

VFD model	Output power (kW)	Input current (A)	Output current (A)
UMI-0007CU-B7	0.75	5	4.5
UMI-0015CU-B7	1.5	7.7	7
UMI-0022CU-B7	2.2	11	10
UMI-0040CU-B7	4	17	16
UMI-0055CU-B7	5.5	21	20
UMI-0075CU-B7	7.5	31	30
UMI-0110CU-B7	11	43	42
UMI-0150CU-B7	15	56	55
UMI-0180CU-B7	18.5	71	70
UMI-0220CU-B7	22	81	80
UMI-0300CU-B7	30	112	110
UMI-0370CU-B7	37	132	130
UMI-0450CU-B7	45	163	160
UMI-0550CU-B7	55	200	200

**Note:**

- The input current of 0.75–55 kW VFDs is measured at the input voltage of 220V without reactors.
- The rated output current is the output current measured at the output voltage of 220V.
- Within the allowable input voltage range, the output current/power cannot exceed the rated output

current/power.

### 3.6.2 AC 3PH 380V–480V

Inverter model	Output power (kW)	Input current (A)	Output current (A)
UMI-0015EU-B7	1.5	5	3.7
UMI-0022EU-B7	2.2	5.8	5
UMI-0040EU-B7	4	13.5	9.5
UMI-0055EU-B7	5.5	19.5	14
UMI-0075EU-B7	7.5	25	18.5
UMI-0110EU-B7	11	32	25
UMI-0150EU-B7	15	40	32
UMI-0180EU-B7	18.5	47	38
UMI-0220EU-B7	22	56	45
UMI-0300EU-B7	30	70	60
UMI-0370EU-B7	37	80	75
UMI-0450EU-B7	45	94	92
UMI-0550EU-B7	55	128	115
UMI-0750EU-B7	75	160	150
UMI-0900EU-B7	90	190	180
UMI-1100EU-B7	110	225	215
UMI-1320EU-B7	132	265	260
UMI-1600EU-B7	160	310	305
UMI-1850EU-B7	185	345	340
UMI-2000EU-B7	200	385	380
UMI-2200EU-B7	220	430	425
UMI-2500EU-B7	250	485	480
UMI-2800EU-B7	280	545	530
UMI-3150EU-B7	315	610	600
UMI-3500EU-B7	350	625	650
UMI-4000EU-B7	400	715	720
UMI-5000EU-B7	500	890	860

**Note:**

- The input current of 1.5–200kW VFDs is measured at the input voltage of 460V without reactors.
- The input current of 220–500kW VFDs is measured at the input voltage of 460V with reactors.
- The rated output current is the output current measured at the output voltage of 460V.
- Within the allowable input voltage range, the output current/power cannot exceed the rated output current/power.

**3.6.3 AC 3PH 520V–600V**

<b>Inverter model</b>	<b>Output power (kW)</b>	<b>Input current (A)</b>	<b>Output current (A)</b>
UMI-0007FU-B7	0.75	3.3	2.1
UMI-0015FU-B7	1.5	5	3.2
UMI-0022FU-B7	2.2	7	4.5
UMI-0040FU-B7	4	10	6.5
UMI-0055FU-B7	5.5	13	9
UMI-0075FU-B7	7.5	16.5	12
UMI-0110FU-B7	11	19	16
UMI-0150FU-B7	15	24	21
UMI-0180FU-B7	18.5	35	27
UMI-0220FU-B7	22	40	35
UMI-0300FU-B7	30	47	45
UMI-0370FU-B7	37	52	52
UMI-0450FU-B7	45	65	62
UMI-0550FU-B7	55	85	86
UMI-0750FU-B7	75	95	98
UMI-0900FU-B7	90	118	120
UMI-1100FU-B7	110	145	150

**Note:**

- The input current of 0.75–110kW VFDs is measured at the input voltage of 575V without reactors.
- The rated output current is the output current measured at the output voltage of 575V.
- Within the allowable input voltage range, the output current/power cannot exceed the rated output current/power.

### 3.7 Structure diagram

The VFD layout is shown in the figure below (using the VFD of 460V 30kW as an example).

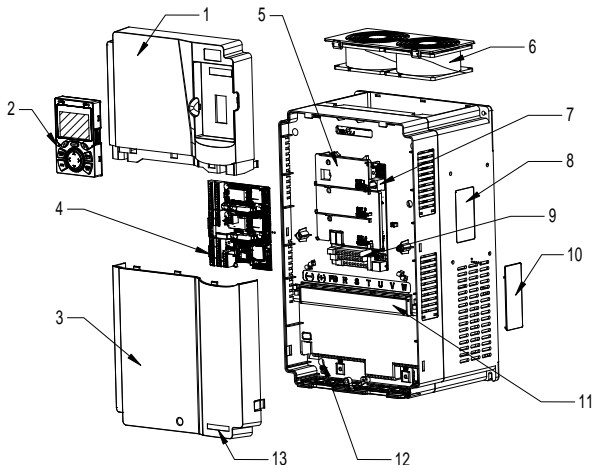

Figure 3-7 Structure diagram

No.	Name	Instruction
1	Upper cover	Protect internal components and parts
2	Keypad	See section 5.4 Operating the VFD through the keypad for details.
3	Lower cover	Protect internal components and parts
4	Expansion card	Optional, see Appendix A for details.
5	Baffle of control board	Protect the control board and install expansion card
6	Cooling fan	See chapter 8 Maintenance.
7	Keypad interface	Connect the keypad
8	Nameplate	See section 3.4 Product nameplate for details.
9	Control terminals	See chapter 4 Installation guidelines for details.
10	Cover plate of heat emission hole	Optional. Cover plate can upgrade protection level, however, as it will also increase internal temperature, derated use is required.
11	Main circuit terminal	See chapter 4 Installation guidelines for details.
12	POWER indicator	Power indicator
13	Label of UMI-B7 product series	See section 3.5 Model code for details.



## 4 Installation guidelines

### 4.1 What this chapter contains

This chapter introduces the mechanical and electrical installations of the VFD.

	<ul style="list-style-type: none"> <li>✧ Only well trained and qualified professionals are allowed to carry out the operations mentioned in this chapter. Please carry out operations according to instructions presented in Safety precautions. Ignoring these safety precautions may lead to physical injury or death, or device damage.</li> <li>✧ Ensure the VFD power is disconnected before installation. If the VFD has been powered on, disconnect the VFD and wait for at least the time designated on the VFD, and ensure the POWER indicator is off. You are recommended to use a multimeter to check and ensure the VFD DC bus voltage is below 36V.</li> <li>✧ Installation must be designed and done according to applicable local laws and regulations. Unitronics does not assume any liability whatsoever for any installation which breaches local laws and regulations. If recommendations given by Unitronics are not followed, the VFD may experience problems that the warranty does not cover.</li> </ul>
---	--

### 4.2 Mechanical installation

#### 4.2.1 Installation environment

Installation environment is essential for the VFD to operate at its best in the long run. The installation environment of the VFD should meet the following requirements.

Environment	Condition
Installation site	Indoor
Ambient temperature	<ul style="list-style-type: none"> <li>✧ -10–+50°C</li> <li>✧ When the ambient temperature exceeds 40°C, derate 1% for every additional 1°C. For details about derating, see section B.2.2 Derating.</li> <li>✧ It is not recommended to use the VFD when the ambient temperature is above 50°C.</li> <li>✧ In order to improve reliability, do not use the VFD in cases where the temperature changes rapidly.</li> <li>✧ When the VFD is used in a closed space such as control cabinet, use cooling fan or air conditioner to prevent internal temperature from exceeding the temperature required.</li> <li>✧ When the temperature is too low, if restart a VFD which has been idled for a long time, it is required to install external heating device before use to eliminate the freeze inside the VFD, failing to do so may cause damage to the VFD.</li> </ul>
Humidity	✧ The relative humidity (RH) of the air is less than 90%.

Environment	Condition
	<ul style="list-style-type: none"> <li>◇ Condensation is not allowed.</li> <li>◇ The max RH cannot exceed 60% in the environment where there are corrosive gases.</li> </ul>
Storage temperature	-30~+60°C
Running environment	<p>The installation site should meet the following requirements.</p> <ul style="list-style-type: none"> <li>◇ Away from electromagnetic radiation sources.</li> <li>◇ Away from oil mist, corrosive gases and combustible gases.</li> <li>◇ Ensure foreign object like metal powder, dust, oil and water will not fall into the VFD (do not install the VFD onto combustible object like wood).</li> <li>◇ Away from radioactive substance and combustible objects.</li> <li>◇ Away from harmful gases and liquids.</li> <li>◇ Low salt content.</li> <li>◇ No direct sunlight</li> </ul>
Altitude	<ul style="list-style-type: none"> <li>◇ Below 1000m.</li> <li>◇ When the altitude exceeds 1000m, derate 1% for every additional 100m.</li> <li>◇ When the altitude exceeds 3000m, consult with the Unitronics support.</li> </ul>
Vibration	Max. vibration acceleration: 5.8m/s <sup>2</sup> (0.6g)
Installation direction	Install the VFD vertically to ensure good heat dissipation effect

**Note:**

- The UMI-B7 series VFD should be installed in a clean and well-ventilated environment based on the IP level.
- The cooling air must be clean enough and free from corrosive gases and conductive dust.

**4.2.2 Installation direction**

The VFD can be installed on the wall or in a cabinet.

The VFD must be installed vertically. Check the installation position according to following requirements. See Appendix C Dimensions.

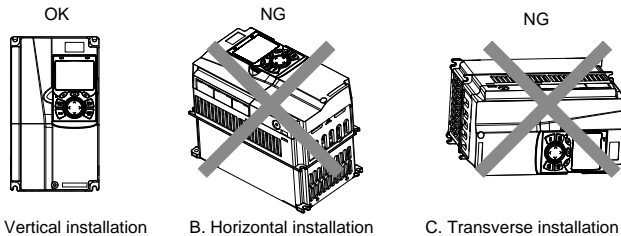

Figure 4-1 Installation direction of the VFD

**4.2.3 Installation mode**

There are three kinds of installation modes based on different VFD dimensions.

- Wall-mounting: for the VFDs of 220V≤55kW, 460V ≤200kW, and 575V
- Flange-mounting: for the VFDs of 220V≤55kW, 460V ≤200kW, and 575V
- Floor-mounting: for the VFDs of 460V 220–500kW

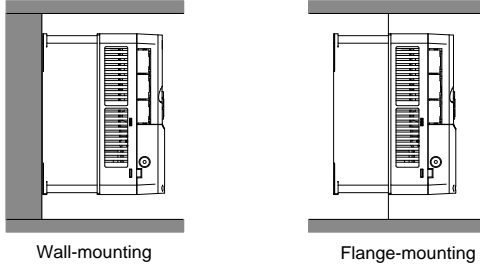

Figure 4-2 Installation mode

The installation steps are described as follows:

1. Mark the position of the installation hole. See Appendix C Dimensions for the position of installation hole.
2. Mount the screws or bolts onto the designated position.
3. Put the VFD on the wall.
4. Tighten the fixing screws on the wall.

**Note:**

Flange plates are required when installing VFDs of 220V 0.75–15kW and 460V in flange mode, and for VFDs of 220V 18.5–55kW and 460V 37–200kW, no flange plate is required.

**4.2.4 Single-unit installation**

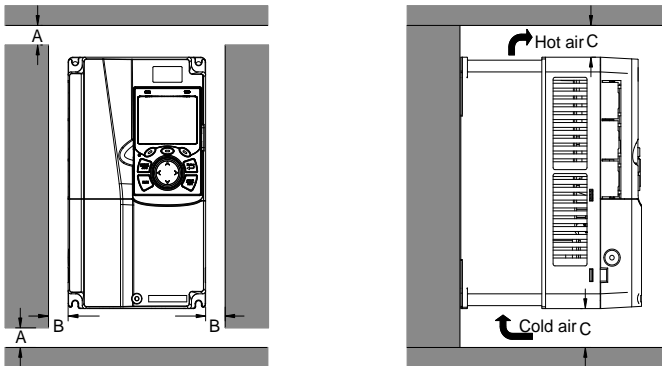

Figure 4-3 Single-unit installation

**Note:** The min. dimension of A, B and C is 100mm.

4.2.5 Multiple-unit installation

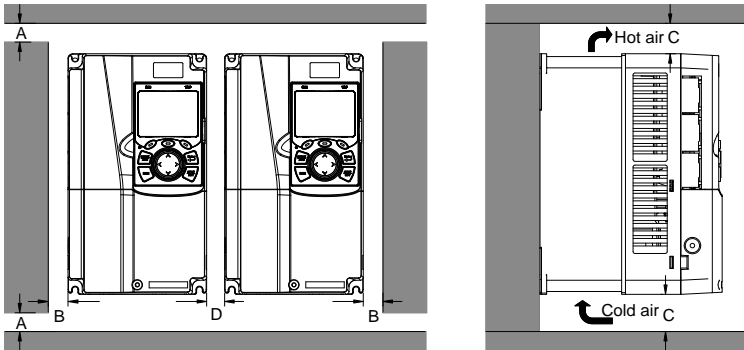

Figure 4-4 Parallel installation

**Note:**

- When you install VFDs in different sizes, align the top of each VFD before installation for the convenience of future maintenance.
- The min. dimension of A, B, D and C is 100mm.

4.2.6 Vertical installation

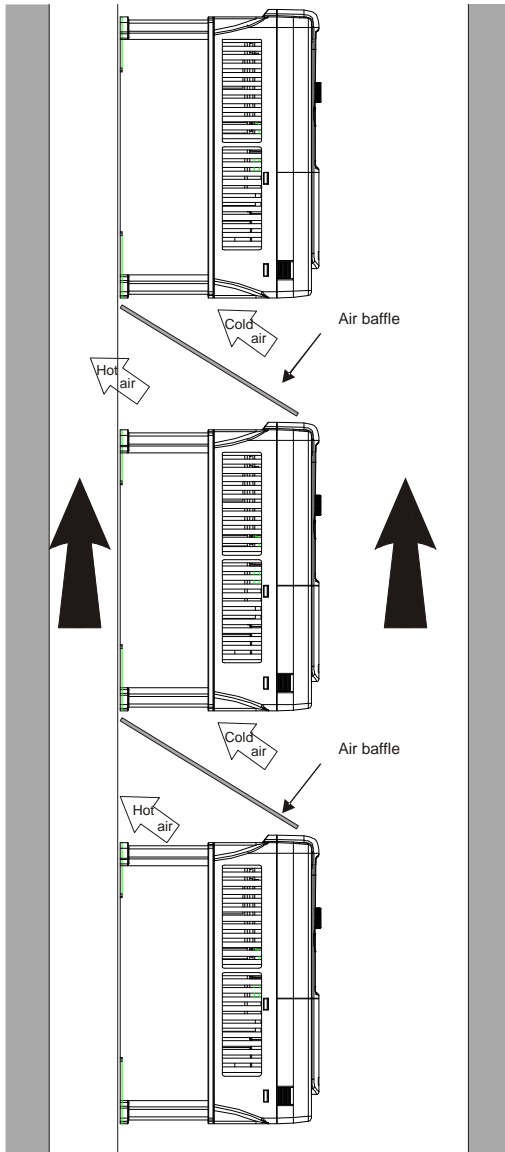

Figure 4-5 Vertical installation

**Note:** During vertical installation, you must install air baffles; otherwise, the VFD will experience mutual interference, and the heat dissipation effect will be degraded.

### 4.2.7 Tilted installation

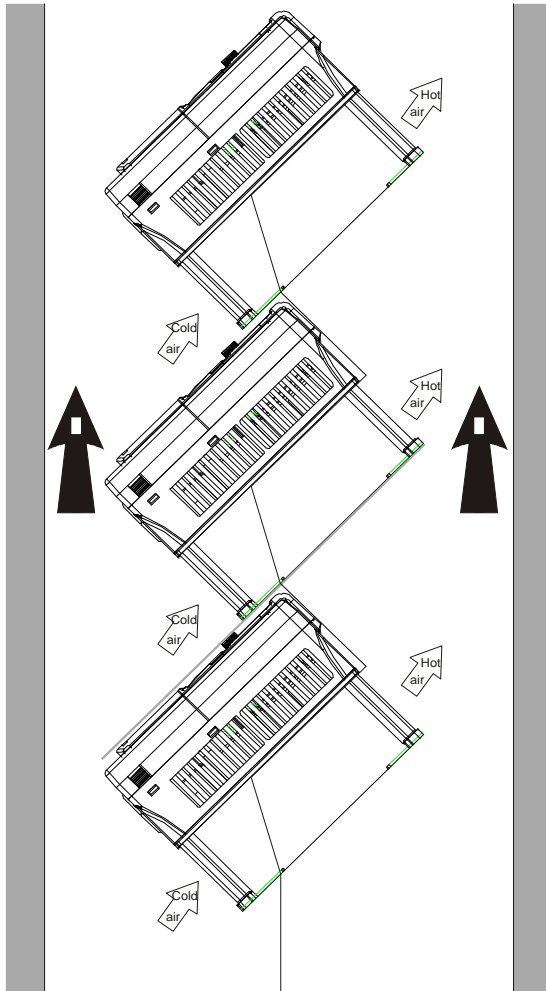

Figure 4-6 Tilted installation

**Note:** During tilted installation, it is a must to ensure the air inlet duct and air outlet duct are separated from each other to avoid mutual interference.

### 4.3 Standard wiring of main circuit

#### 4.3.1 Wiring diagram of main circuit

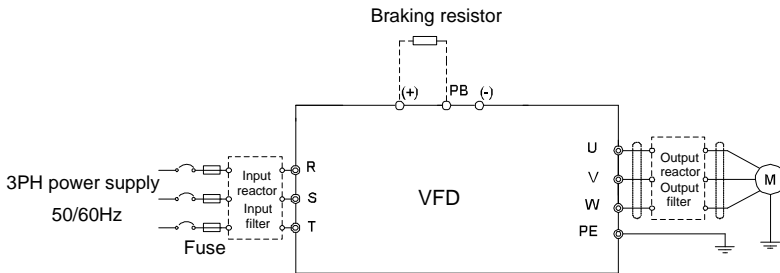

Figure 4-7 Connection diagram of main circuit for the VFD of 220V  $\leq$ 15kW and 460V  $\leq$ 30kW

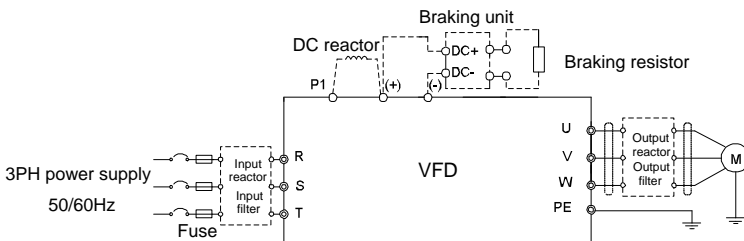

Figure 4-8 Connection diagram of main circuit for the VFDs of 220V 18.5–55kW, and 460V  $\geq$ 37kW

**Note:**

- The fuse, DC reactor, braking unit, braking resistor, input reactor, input filter, output reactor, and output filter are optional parts. See Appendix D Optional peripheral accessories for details.
- P1 and (+) are short circuited in factory for VFDs of 220V  $\geq$ 18.5kW and 460V  $\geq$ 37kW. If you need to use them to connect the DC reactor, remove the contact tag between P1 and (+).
- When connecting the braking resistor, take off the yellow warning signs marked with (+) and (-) on the terminal block before connecting the braking resistor wire. Otherwise, poor contact may occur.

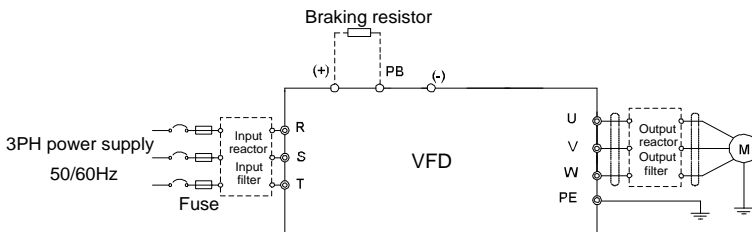

Figure 4-9 Connection diagram of main circuit for the VFDs of 575V 0.75–18.5kW

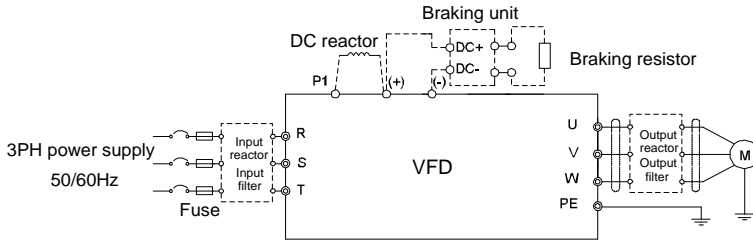

Figure 4-10 Connection diagram of main circuit for the VFDs of 575V  $\geq 22$ kW

**Note:**

- The fuse, DC reactor, braking resistor, input reactor, input filter, output reactor, and output filter are optional parts. See Appendix D Optional peripheral accessories for details.
- P1 and (+) are short circuited in factory. If you need to use them to connect the DC reactor, remove the jumper between P1 and (+).

**4.3.2 Main circuit terminal diagram**

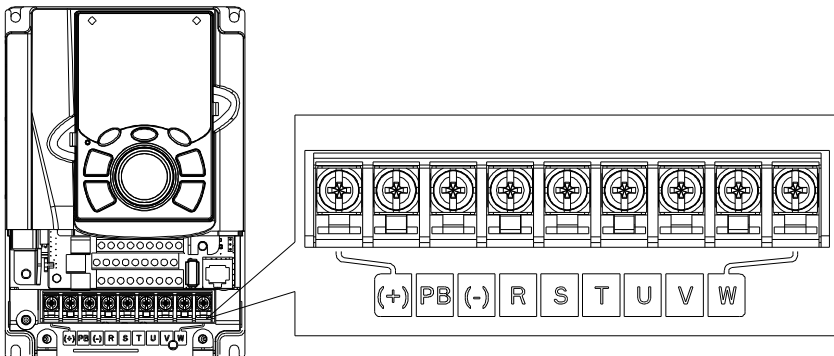

Figure 4-11 Terminals of main circuit for the VFDs of 220V 0.75kW and 460V 1.5–2.2kW



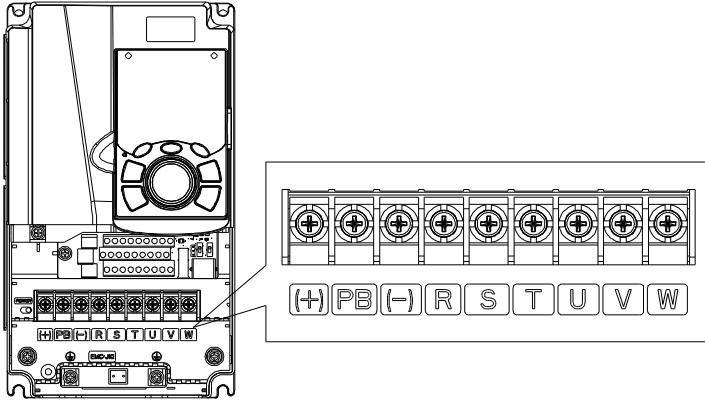

Figure 4-12 Terminals of main circuit for the VFDs of 220V 1.5–2.2kW, 460V 4–5.5kW, and 575V 0.75–2.2kW

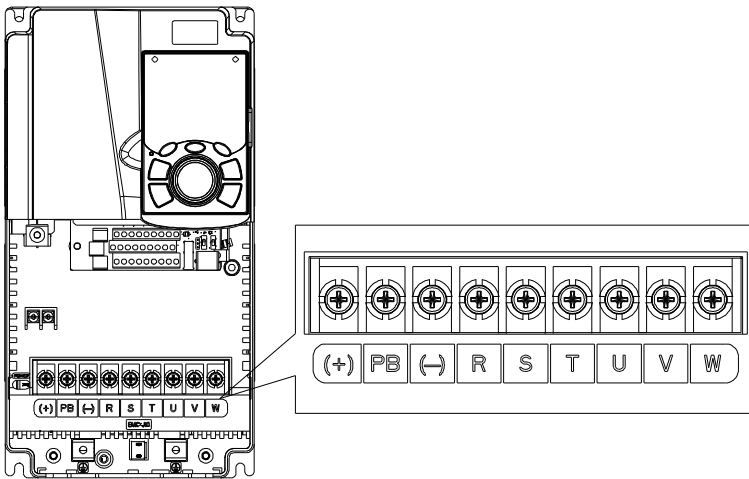

Figure 4-13 Terminals of main circuit for the VFDs of 220V 4–5.5kW, 460V 7.5–11kW, and 575V 4–7.5kW

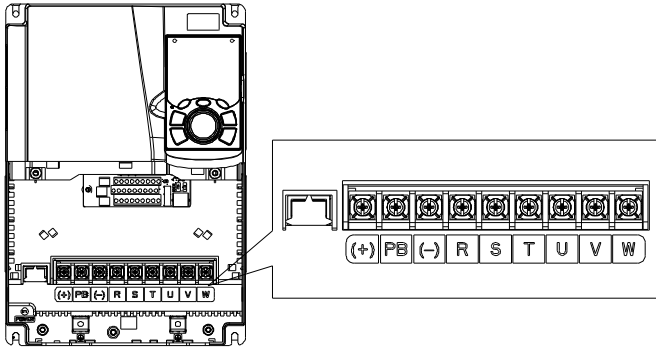

Figure 4-14 Terminals of main circuit for the VFDs of 220V 7.5kW, 460V 15–18.5kW, and 575V 11–18.5kW

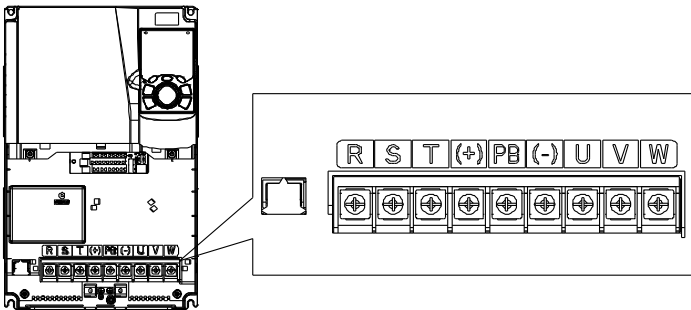

Figure 4-15 Terminals of main circuit for the VFDs of 220V 11–15kW and 460V 22–30kW

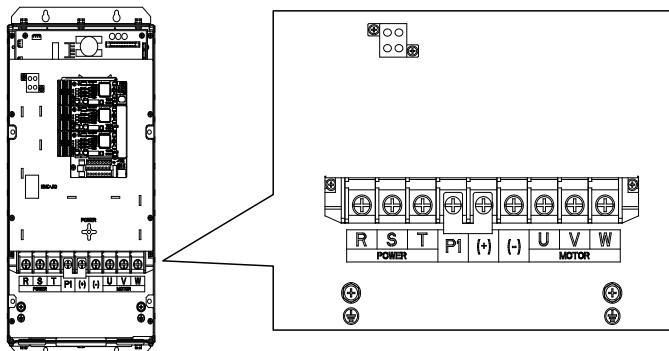

Figure 4-16 Terminals of main circuit for the VFDs of 220V 18.5–30kW, 460V 37–55kW, and 575V 22–37kW

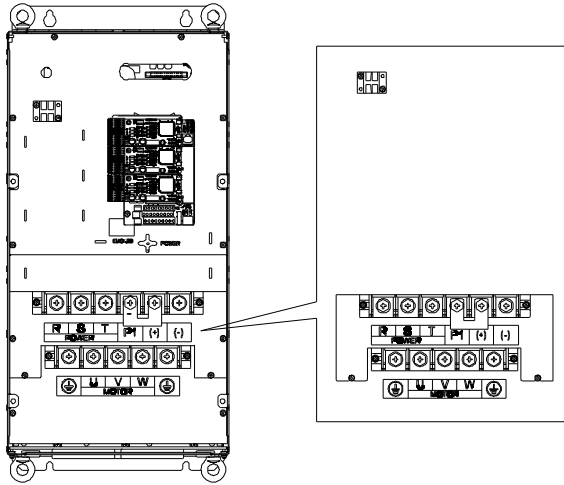

Figure 4-17 Terminals of main circuit for the VFDs of 220V 37–55kW, 460V 75–110kW, and 575V 45–110kW

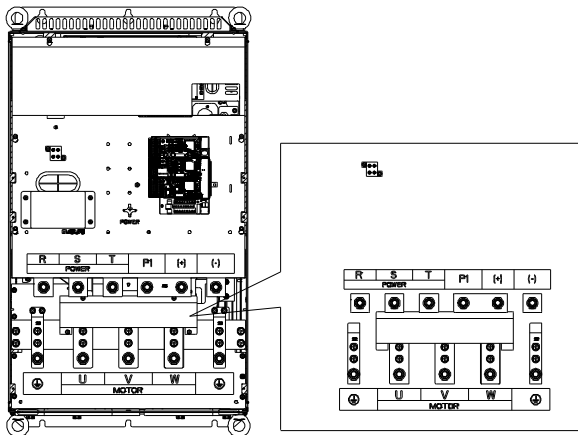

Figure 4-18 Terminals of main circuit for the VFDs of 460V 132–200kW

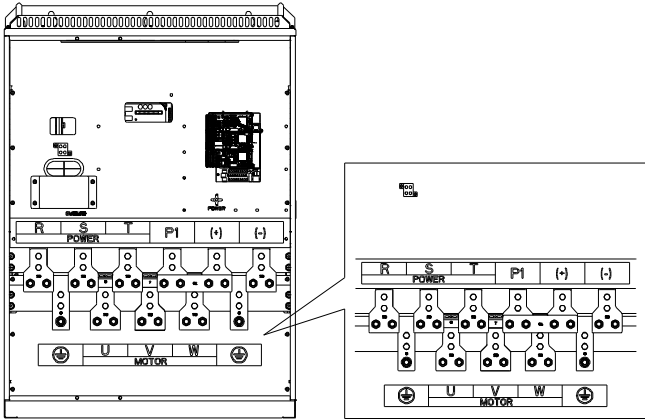

Figure 4-19 Terminals of main circuit for the VFDs of 460V 220–315kW

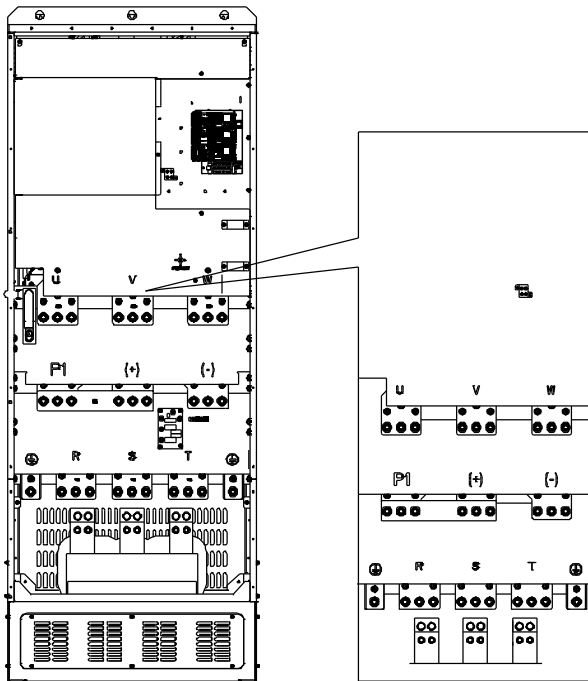

Figure 4-20 Terminals of main circuit for the VFDs of 460V 350–500kW

Terminal	220V ≤15kW		Function
	220V ≥18.5kW		
	460V ≤30kW		
	460V ≥37kW		
	575V ≥22kW		
R, S, T	Power input of the main circuit		3-phase AC input terminals which are generally connected with the power supply.
U, V, W	VFD output		3-phase AC output terminals which are generally connected with the motor.
P1	/	DC reactor terminal 1	P1 and (+) are connected with the terminals of DC reactor. (+) and (-) are connected with the terminals of braking unit.
(+)	Braking resistor terminal 1	DC reactor terminal 2, braking unit terminal 1	
(-)	/	Braking unit terminal 2	
PB	Braking resistor terminal 2	/	PB and (+) are connected with the terminals of braking resistor.
PE	460V: the grounding resistor is less than 100hm		Protective grounding terminal. Each machine provides two PE terminals as the standard configuration. These terminals should be grounded with proper techniques.

**Note:**

- VFDs of 575V 0.75–18.5kW do not carry P1.
- It is not recommended to use asymmetrical motor cables. If there is a symmetrical grounding conductor in the motor cable besides the conductive shielded layer, ground the grounding conductor on the VFD end and motor end.
- Brake resistor, braking unit and DC reactor are optional parts.
- Route the motor cable, input power cable and control cables separately.
- If the terminal description is "/", the machine does not provide the terminal as the external terminal.
- When sharing the DC bus, the VFDs must be the same in power and must be simultaneously powered on or off.
- In shared DC bus running mode, current balance on the VFD input side must be considered during wiring, and equalizing reactors are recommended to be configured.

**4.3.3 Wiring process of the main circuit terminals**

1. Connect the grounding line of the input power cable to the grounding terminal (PE) of the VFD, and connect the 3PH input cable to R, S and T terminals and tighten up.
2. Connect the grounding line of the motor cable to the grounding terminal of the VFD, and connect 3PH motor cable to U, V and W terminals and tighten up.
3. Connect the braking resistor which carries cables to the designated position.

- Fix all the cables outside the VFD mechanically if allowed.

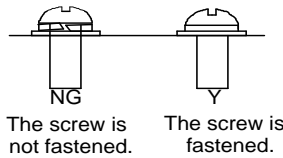

Figure 4-21 Screw installation diagram

## 4.4 Standard wiring of control circuit

### 4.4.1 Wiring diagram of basic control circuit

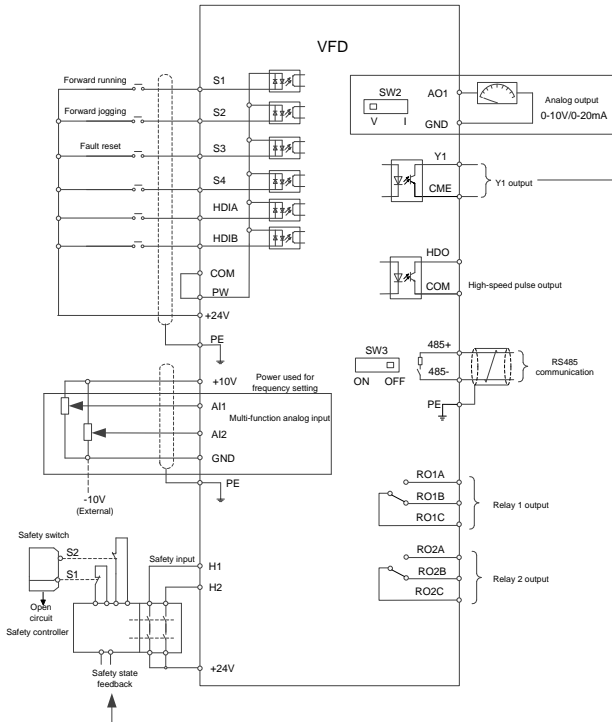

Figure 4-22 Wiring diagram of control circuit

**Note:** If wire-passing board outlet space is insufficient when all terminals on the control board are wired, cut the knock-out hole on the lower cover for wire outlet. If a dangerous situation occurs when the knock-out hole is cut for a purpose but not wire outlet, we will not bear any responsibility.

Terminal name	Instruction	
+10V	Locally provided +10.5V power	
AI1	<ul style="list-style-type: none"> <li>Input range: AI1 voltage/current can choose 0–10V/ 0–20mA</li> </ul>	
AI2	<ul style="list-style-type: none"> <li>AI2: -10V→+10V voltage</li> <li>Input impedance: 20kΩ during voltage input; 250Ω during current input</li> <li>AI1 voltage or current input is set by P05.50</li> <li>Resolution ratio: When 10V corresponds to 50Hz, the min. resolution ratio is 5mV</li> <li>25°C, When input above 5V or 10mA, the error is ±0.5%</li> </ul>	
GND	Reference ground of +10.5V	
AO1	<ul style="list-style-type: none"> <li>Output range: 0–10V voltage or 0–20mA current</li> <li>Voltage or current output is set by switch SW2</li> <li>25°C, when output is above 5V or 10mA, the error is ±0.5%</li> </ul>	
RO1A	RO1 relay output; RO1A is NO, RO1B is NC, RO1C is common port Contact capacity: 3A/AC250V, 1A/DC30V	
RO1B		
RO1C		
RO2A	RO2 relay output; RO2A is NO, RO2B is NC, RO2C is common port Contact capacity: 3A/AC250V, 1A/DC30V	
RO2B		
RO2C		
HDO	<ul style="list-style-type: none"> <li>Switch capacity: 50mA/30V</li> <li>Range of output frequency: 0–50kHz</li> <li>Duty ratio: 50%</li> </ul>	
COM	Reference ground of +24V	
CME	Common port of open collector output; short connected to COM by default	
Y1	<ul style="list-style-type: none"> <li>Switch capacity: 50mA/30V</li> <li>Range of output frequency: 0–1kHz</li> </ul>	
485+	RS485 differential signal communication port. The standard RS485 communication interface should use shielded twisted pair; the 120Ω terminal matching resistor of RS485 communication is connected by switch SW3.	
485-		
PE	Grounding terminal	
PW	External power input terminal for digital input circuits. In NPN mode, short connect PW and +24V. In PNP mode, short connect PW and COM. Voltage range: 12–30V	
24V	User power provided by the VFD. Max. output current: 200mA	
S1	Digital input 1	<ul style="list-style-type: none"> <li>Internal impedance: 3.3kΩ</li> <li>Accept 12–30V voltage input</li> <li>Bi-directional input terminals, supporting NPN/PNP connection modes</li> <li>Max. input frequency: 1kHz</li> <li>All are programmable digital input terminals, you can set the</li> </ul>
S2	Digital input 2	
S3	Digital input 3	
S4	Digital input 4	

Terminal name	Instruction	
		terminal function via function codes
HDIA	Channels for both high frequency pulse input and digital input	
HDIB	Max. input frequency: 50kHz Duty ratio: 30%–70% Supports the quadrature encoder input of 24V power supply; equipped with speed-measurement function	
+24V—H1	STO input 1	<ul style="list-style-type: none"> <li>Safe torque off (STO) redundant input, connect to external NC contact, STO acts when the contact opens, and the VFD stops output</li> <li>Safety input signal wires use shielded wire whose length is within 25m</li> <li>H1 and H2 terminals are short connected to +24V by default; it is required to remove the jumper on the terminal before using STO function.</li> </ul>
+24V—H2	STO input 2	

**4.4.2 Input/output signal connection diagram**

Set NPN/PNP mode and internal/external power via U-shaped jumper. PNP internal mode is adopted by default.

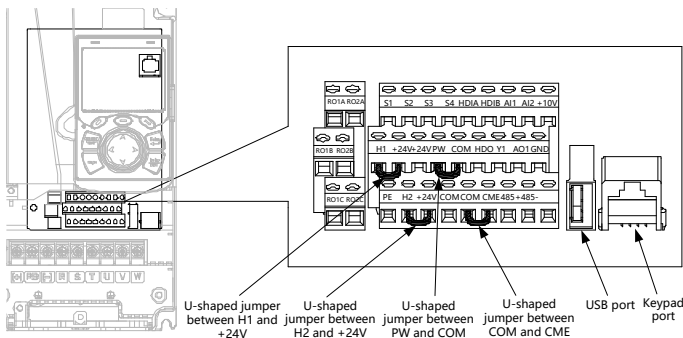

Figure 4-23 Position of U-shaped jumper

**Note:** As shown in Figure 4-23, the USB port can be used to upgrade the software, and the keypad port can be used to connect an external keypad. The external keypad cannot be used when the keypad of the VFD is used.

If input signal comes from NPN transistors, set the U-shaped jumper between +24V and PW based on the power used according to the figure below.



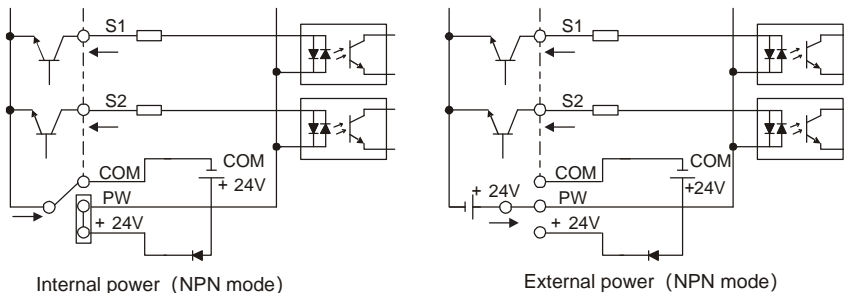

Figure 4-24 NPN mode

If input signal comes from PNP transistor, set the U-shaped jumper based on the power used according to the figure below.

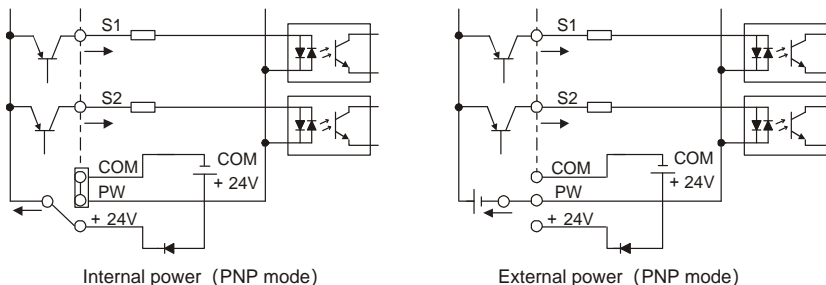

Figure 4-25 PNP mode

### 4.5 Wiring protection

#### 4.5.1 Protecting the VFD and input power cable in short circuit

Protect the VFD and input power cable during short-circuit to avoid thermal overload.

Carry out protective measures according to the following requirements.

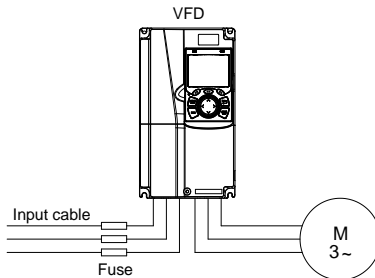



Figure 4-26 Fuse configuration

**Note:** Select the fuse according to the operation manual. During short-circuit, the fuse will protect input power cables to avoid damage to the VFD; when internal short-circuit occurs to the VFD, it can protect

neighboring equipment from being damaged.

**4.5.2 Protecting the motor and motor cable in short circuit**

If the motor cable is selected based on rated VFD current, the VFD will be able to protect the motor cable and motor during short circuit without other protective devices.

	<p>⚡ If the VFD is connected to multiple motors, it is a must to use a separated thermal overload switch or breaker to protect the cable and motor, which may require the fuse to cut off the short circuit current.</p>
---	--

**4.5.3 Protecting the motor and preventing thermal overload**

According to the requirements, the motor must be protected to prevent thermal overload. Once overload is detected, you must cut off the current. The VFD is equipped with motor thermal overload protection function, which will block output and cut off the current (if necessary) to protect the motor.

**4.5.4 Bypass connection**

In some critical occasions, industrial frequency conversion circuit is necessary to ensure proper operation of the system when VFD fault occurs.

In some special cases, such as only soft startup is needed, it will convert to power-frequency operation directly after soft startup, corresponding bypass link is also needed.

	<p>⚡ Do not connect any power source to VFD output terminals U, V and W. The voltage applied to motor cable may cause permanent damage to the VFD.</p>
---	--

If frequent switchover is needed, you can use the switch which carries mechanical interlock or a contactor to ensure motor terminals will not be connected to input power cables and VFD output ends simultaneously.

## 5 Basic operation instructions

### 5.1 What this chapter contains

This chapter tells how to use the VFD keypad and the commissioning procedures for common functions of the VFD.

### 5.2 Keypad introduction

The LCD keypad is included in the standard configuration of UMI-B7 series VFD. You can control the VFD start/stop, read state data and set parameters via keypad.

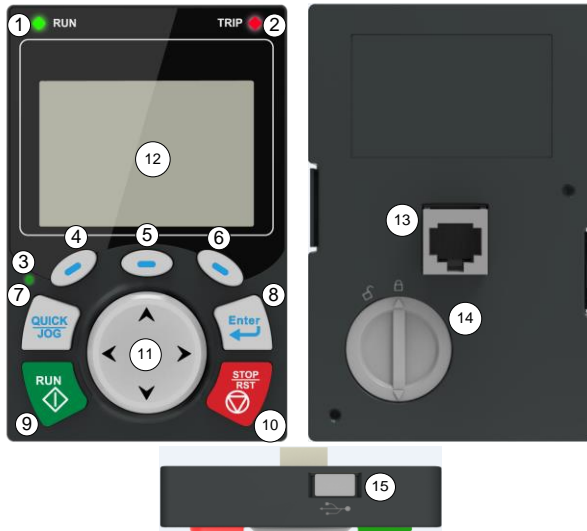

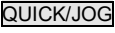













Figure 5-1 Keypad diagram

**Note:**

1. LCD keypad is armed with real-time clock, which can run properly after power off when installed with batteries. The battery (type: CR2032) should be purchased separately.
2. LCD keypad support parameter-copy.
3. When extending the keypad cable to install the keypad, M3 screws can be used to fix the keypad onto the door plate, or optional keypad installation bracket can be used. If you need install the keypad on another position rather than on the VFD, use a keypad extension cable with a standard RJ45 crystal head.

No.	Name	Instruction		
1	State Indicator	(1)		Running indicator; LED off – the VFD is stopped; LED blinking – the VFD is in parameter autotune

No.	Name	Instruction		
		(2)		LED on – the VFD is running Fault indicator; LED on – in fault state LED off – in normal state LED blinking – in pre-alarm state
		(3)		Short-cut key indicator, which displays different state under different functions, see definition of <b>QUICK/JOG</b> key for details
2	Button area	(4)		Function key The function of function key varies with the menu; The function of function key is displayed in the footer
		(5)		
		(6)		
		(7)		Short-cut key Re-definable. It is defined as JOG function by default, namely jogging. The function of short-cut key can be set by the ones of P07.02, as shown below. 0: No function 1: Jogging (linkage indicator (3); logic : NO) 2: Reserved 3: FWD/REV switchover (linkage indicator (3); logic: NC) 4: Clear <b>UP/DOWN</b> setting (linkage indicator (3) logic: NC) 5: Coast to stop (linkage indicator (3); logic: NC) 6: Switching running command reference mode in order (linkage indicator (3); logic: NC) 7: Reserved <b>Note:</b> After restoring to

No.	Name	Instruction			
					default values, the default function of short-cut key (7) is 1.
		(8)		Confirmation key	The function of confirmation key varies with menus, such as confirming parameter setting, confirming parameter selection, entering the next menu, etc.
		(9)		Running key	Under keypad operation mode, the running key is used for running operation or autotuning operation.
		(10)		Stop/Reset key	During running state, press the Stop/Reset key can stop running or autotuning; this key is limited by P07.04. During fault alarm state, all the control modes can be reset by this key.
		(11)		Direction key UP:  DOWN:  LEFT:  RIGHT: 	UP: The function of UP key varies with interfaces, such as shifting up the displayed item, shifting up the selected item, and changing digits; DOWN: The function of DOWN key varies with interfaces, such as shifting down the displayed item, shifting down the selected item, and changing digits; LEFT: The function of LEFT key varies with interfaces, such as switch over the monitoring interface, such as shifting the cursor leftward, exiting current menu and returning to previous menu; RIGHT: The function of

No.	Name	Instruction			
					RIGHT key varies with interfaces, such as switch over the monitoring interface, shifting the cursor rightward, enter the next menu etc.
3	Display area	(12)	LCD	Display screen	240×160 dot-matrix LCD; display three monitoring parameters or six sub-menu items simultaneously
4	Others	(13)	RJ45 interface	RJ45 interface	RJ45 interface is used to connect to the VFD.
		(14)	Battery cover	Clock battery cover	Remove this cover when replacing or installing clock battery, and close the cover after battery is installed
		(15)	USB terminal	mini USB terminal	Mini USB terminal is used to connect to the USB flash drive through an adapter.

The LCD has different display areas, which displays different contents under different interfaces. The figure below is the main interface of stop state.

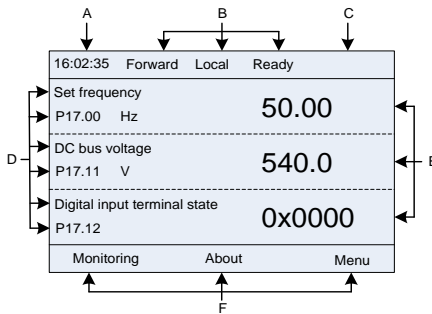

Figure 5-2 Main interface of LCD



Area	Name	Used to
Header A	Real-time display area	Display the real-time; clock battery is not included; the time needs to be reset when powering on the VFD
Header B	VFD running state display area	Display the running state of the VFD: 1. Display motor rotating direction: "Fwd" – Run forward during operation; "Rev" – Run reversely during operation; "Disrev" – Reverse running is forbidden; 2. Display VFD running command channel: "Local" –

Area	Name	Used to
		Keypad; "Trml" – Terminal; "Remote" - Communication 3. Display current VFD state: "Ready" – The VFD is in stop state (no fault); "Run" – The VFD is in running state; "Jog" – The VFD is in jogging state; "Pre-alarm" – the VFD is under pre-alarm state during running; "Fault" – VFD fault occurred.
Header C	VFD model display area	VFD model display
Display D	Parameter names and function codes on the VFD homepage	Display a maximum of three parameter names and function codes on the homepage. The parameters displayed on the homepage can be managed.
Display E	Values of parameters on the VFD homepage	Display the values of parameters on the VFD homepage, which are updated in real time.
Footer F	Corresponding menus of function keys (4), (5) and (6)	Indicate the menus corresponding to function keys (4), (5) and (6). The corresponding menus of function keys (4), (5) and (6) vary with interfaces, and the content displayed in this area varies also.

### 5.3 Keypad display

The VFD keypad can display the stopped-state parameters, running-state parameters, and fault alarm status.

#### 5.3.1 Displaying stopped-state parameters

When the VFD is in stopped state, the keypad displays stopped-state parameters, and this interface is the main interface during power-up by default. In stopped state, parameters in various states can be displayed. Press  or  to shift the displayed parameter up or down.

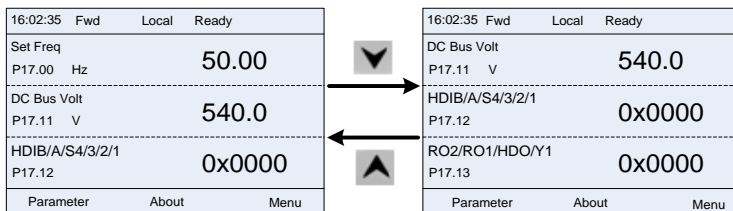



Figure 5-3 Stopped-state parameter display 1

Press  or  to switch between different display styles, including list display style and progress bar display style.

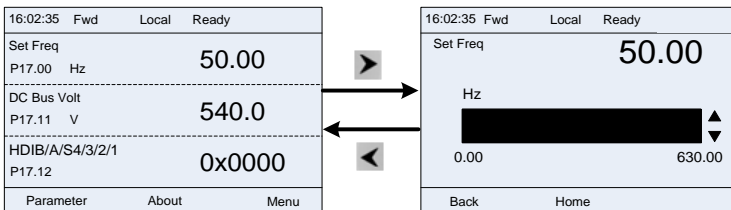

Figure 5-4 Stopped-state parameter display 2

The stopped-state parameter display list is user defined, and each state variable function code can be added to the stopped-state parameter display list as needed. A function code which has been added to the stopped-state parameter display list can also be deleted or shifted.

### 5.3.2 Displaying running-state parameters

After receiving valid running command, the VFD will enter running state, and the keypad displays running state parameter with RUN indicator on the keypad turning on. In running state, multiple kinds of state parameters can be displayed. Press or to shift up or down.

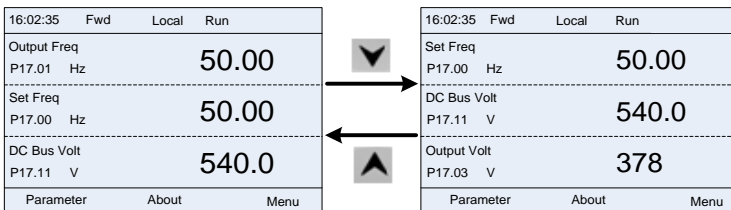

Figure 5-5 Running parameter display state

Press or to switch between different display styles, including list display style and progress bar display style.

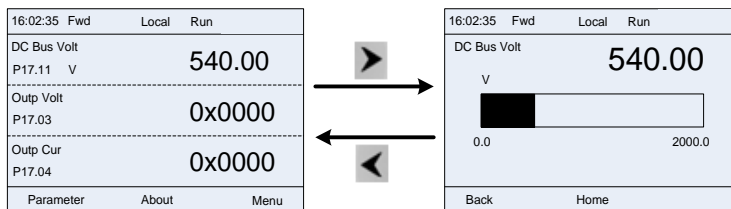

Figure 5-6 Running parameter display state

In running state, multiple kinds of state parameters can be displayed. The running display parameter list is user defined, and each state variable function code can be added to the running display parameter list as needed. A function code which has been added to the running display parameter list can also be deleted or shifted.



### 5.3.3 Displaying fault information

The VFD enters fault alarm display state once fault signal is detected, and the keypad displays fault code and fault information with the **TRIP** indicator on the keypad turning on. Fault reset operation can be carried out via the **STOP/RST** key, control terminal or communication command.

The fault code will be kept displaying until fault is removed.

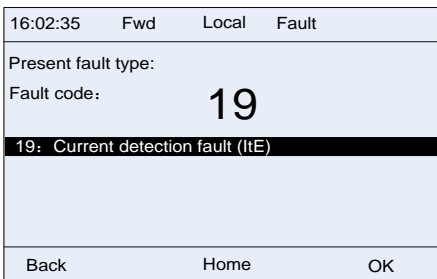

Figure 5-7 Fault alarm display state

### 5.4 Operating the VFD through the keypad

Various operations can be performed on the VFD, including entering/exiting menus, parameter selection, list modification and parameter addition.

#### 5.4.1 Entering/exiting menus

The keypad displays three main menus at the home interface by default: **Parameter**, **About**, and **Menu**.

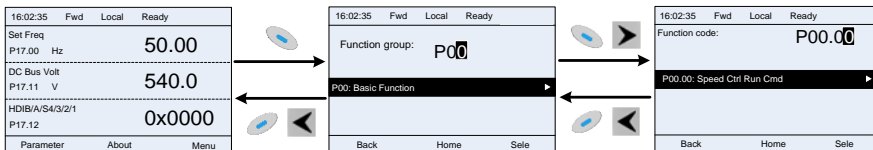

Figure 5-8 Menu entering/exiting diagram 1

The following figure shows how to enter the **Menu** main menu and how to operate under this main menu.

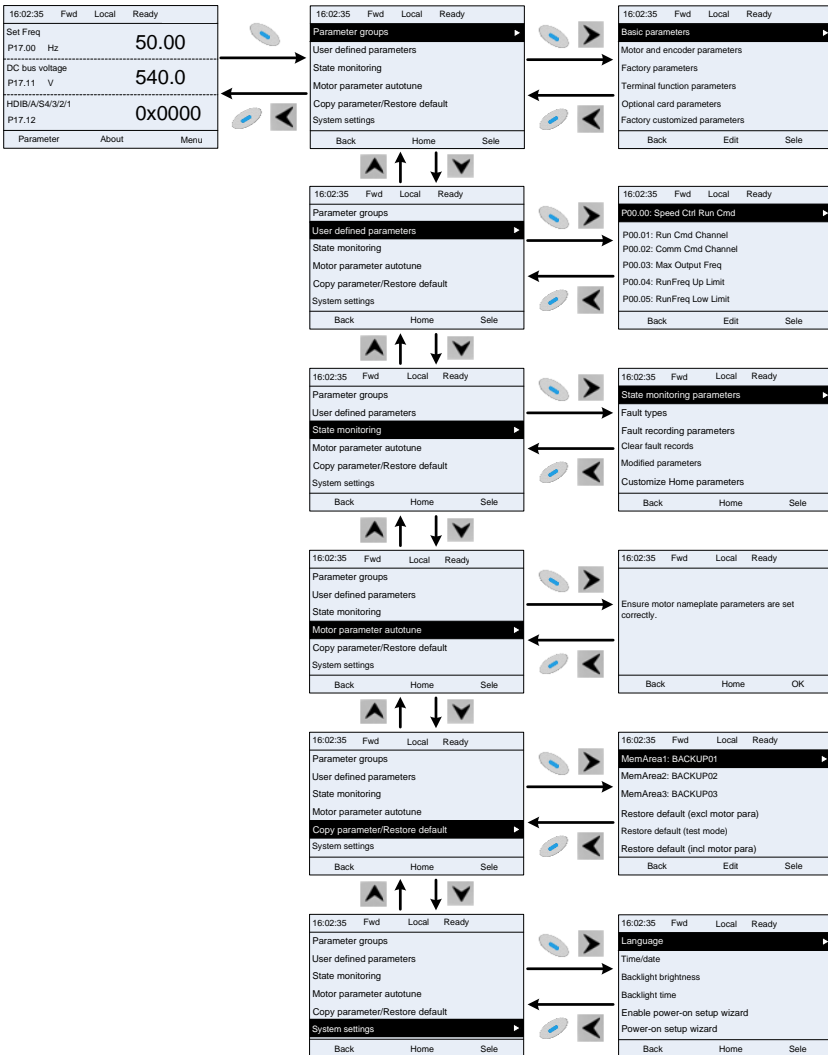

Figure 5-9 Menu entering/exiting diagram 2

The **Menu** interface contains the following submenus by level.

Level 1	Level 2	Level 3	Level 4
Parameter groups	Basic parameters	P00: Basic Function	P00.xx
		P01: Start/stop control	P01.xx
		P03: Motor1 Vector Ctrol	P03.xx
		P04: V/F Control	P04.xx

Level 1	Level 2	Level 3	Level 4
		P07: HMI	P07.xx
		P08: Enhanced Function	P08.xx
		P09: PID Control	P09.xx
		P10: PLC&Mul-stepSpCtrl	P10.xx
		P11: Protection Param	P11.xx
		P13: SM Ctrl Param	P13.xx
		P14: Serial Comm Func	P14.xx
		P21: Position Ctrl	P21.xx
		P22: Spdl Positioning	P22.xx
		P23: Motor 2 Vector Ctrl	P23.xx
	Motor and encoder parameters	P02: Motor 1 Param	P02.xx
		P12: Motor 2 Param	P12.xx
		P20: Motor 1 Encoder	P20.xx
		P24: Motor 2 Encoder	P24.xx
	Factory parameters	P99: Factory Func	P99.xx
	Terminal function parameters	P05: Input Terminals	P05.xx
		P06: Output Terminals	P06.xx
		P98: AIAO Calibration	P98.xx
	Optional card parameters	P15: Comm Ex-card 1	P15.xx
		P16: Comm Ex-card 2	P16.xx
		P25: Ex I/OCard InpFunc	P25.xx
		P26: Ex I/OCard OutpFunc	P26.xx
		P27: PLC Func	P27.xx
		P28: Master/slave Ctrl	P28.xx
	Factory customized parameters	P90: Tension control speed mode	P90.xx
		P91: Tension control torque	P91.xx
		P92: Tension control optimization	P92.xx
	User defined parameters	/	/

Level 1	Level 2	Level 3	Level 4	
State monitoring	State monitoring parameters	P07: HMI	P07.xx	
		P17: State Viewing Func	P17.xx	
		P18: Cl-IpCtrlStateView	P18.xx	
		P19: Ex-card StateView	P19.xx	
		P93: Tension control state viewing func	P93.xx	
	Fault types	/		P07.27: TypeofLatelyFault
				P07.28: Typeof1stLastFault
				P07.29: Typeof2ndLastFault
				P07.30: Typeof3rdLastFault
				P07.31: Typeof4thLastFault
				P07.32: Typeof5thLastFault
	Fault recording parameters	/		P07.33: RunFreq atLatelyFault ... P07.xx: xx state of fault xx
	Clear fault records	/		Sure to clear fault records?
	Modified parameters	/		Pxx.xx: Modified parameter 1
			Pxx.xx: Modified parameter 2	
			Pxx.xx: Modified parameter xx	
Customize Home parameters	/	Stopped-state parameters	/	
		Running-state parameters	/	
Motor parameter autotune	/	Ensure motor nameplate parameters are set correctly.	Complete para rotary autotune	
			Complete para static autotune	
			Partial para static autotune	
			Complete para rotary	

Level 1	Level 2	Level 3	Level 4
			autotune 2 (for AM)
			Partial para static autotune 2 (for AM)
Copy parameter/Restore default	/	MemArea1: BACKUP01	Upload local func para to keypad
			Download all func para from keypad
			Download NonMotor func para from keypad
			Download motor func para from keypad
		MemArea2: BACKUP012	Upload local func para to keypad
			Download all func para from keypad
			Download NonMotor func para from keypad
			Download motor func para from keypad
		MemArea3: BACKUP03	Upload local func para to keypad
			Download all func para from keypad
			Download NonMotor func para from keypad
			Download motor func para from keypad
		Restore default (excl motor para)	Sure to restore defaults (excl motor para)?
		Restore default (test mode)	Sure to restore default (test mode)?
		Restore default (incl motor para)	Sure to restore default (incl motor para)?
System settings	/	/	Language
			Time/date
			Backlight brightness
			Backlight time
			Enable power-on setup wizard

Level 1	Level 2	Level 3	Level 4
			Power-on setup wizard
			Keypad programming
			Fault time setting
			Control board programming
			Up/Down key sensitivity

### 5.4.2 Editing a parameter list

The parameters in the parameter list in stopped state can be added as needed (through the menu of user defined home parameters), and the list can also be edited such as "Move up", "Move down", "Delete from the list", and "Restore default". The edit function is shown in the following.

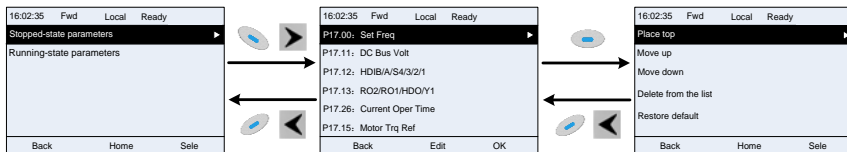

Figure 5-10 List edit diagram 1

Press key to enter edit interface, select the operation needed, and press key, key or key to confirm the edit operation and return to the previous menu (parameter list), the returned list is the list edited. If key or key is pressed in edit interface without selecting edit operation, it will return to the previous menu (parameter list remain unchanged).

**Note:** For the parameter objects in the list header, move-up operation will be invalid, and the same principle can be applied to the parameter objects in the list footer; after deleting a certain parameter, the parameter objects under it will be moved up automatically.

The items in the parameter list in running state can be added as needed (through the menu of user defined home parameters), and the list can also be edited such as "Move up", "Move down", "Delete from the list", and "Restore default parameters". The edit function is shown in the interface below.

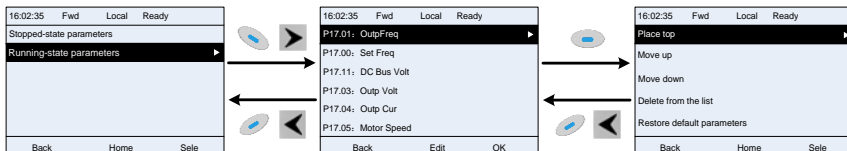

Figure 5-11 List edit diagram 2

The parameters of user defined parameter setting can be added, deleted or adjusted as needed, such as "Move up", "Move down", "Delete from the list", and "Restore default parameters"; the adding function can be set in a certain function code in a function group. The edit function is shown in the figure below.

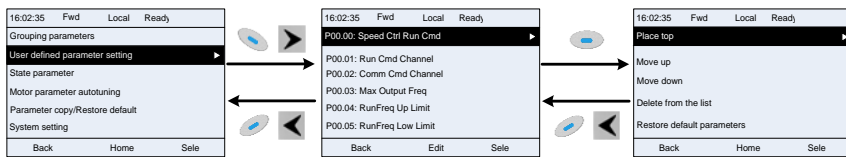

Figure 5-12 List edit diagram 3

### 5.4.3 Adding parameters to the parameter list displayed in stopped/running state

You can choose **Menu > State monitoring**, choose a submenu, enter a specific function group and then a specific function code to add the parameter to the list of parameters displayed in stopped state or parameters displayed in running state.

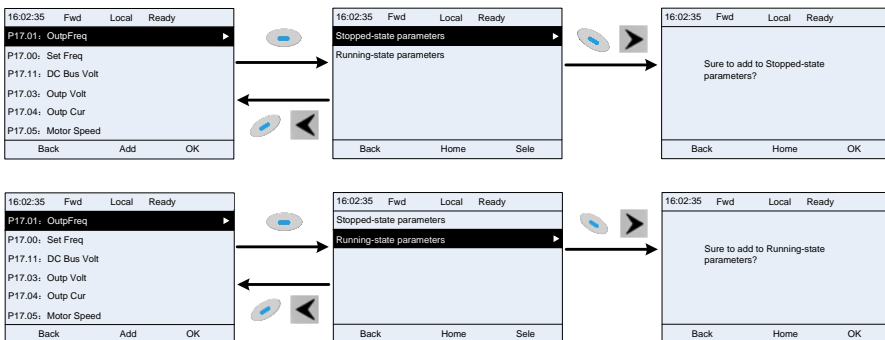

Figure 5-13 Adding parameter diagram 1

After selecting a specific function code, press key to enter the parameter addition interface, and then press key, key or key to confirm the addition operation. If this parameter is not included in the list of parameters displayed in stopped state or parameters displayed in running state, the parameter added will be at the end of the list; if the parameter is already in the list of parameters displayed in stopped state or parameters displayed in running state, the addition operation will be invalid. If key or key is pressed without any selection in the addition interface, it will return to the previous menu.

Part of the monitoring parameters in P07 HMI group can be added to the list of parameters displayed in stopped state or parameters displayed in running state. All the parameters in P17, P18 and P19 group can be added to the list of parameters displayed in stopped state or parameters displayed in running state.

Up to 16 monitoring parameters can be added to the list of parameters displayed in stopped state; and up to 32 monitoring parameters can be added to the list of parameters displayed in running state.

### 5.4.4 Adding parameters to the user defined parameter list

You can choose **Menu > Parameter groups**, choose a submenu, and enter a specific function group

and then a specific function code to add the parameter to the user defined parameter list.

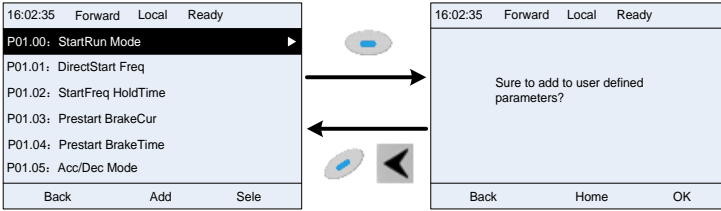

Figure 5-14 Adding parameter diagram 2

Press the key to enter the addition interface, and press key, key or key to confirm the addition operation. If this parameter is not included in the original user defined parameter list, the newly-added parameter will be at the end of the list; if this parameter is already in the list, the addition operation will be invalid. If key or key is pressed without any selection, it will return to the previous menu.

All the function code groups under the parameter group menu can be added to the user defined parameter list. Up to 64 function codes can be added to the user defined parameter list.

### 5.4.5 Editing user defined parameters

After accessing a specific function code under the **User defined parameters** menu, you can press the key, key or key to enter parameter selection edit interface. After entering the edit interface, the present value will be highlighted. Press key and key to edit current parameter value, and the corresponding parameter item of the value will be highlighted automatically. After parameter selection is done, press key or key to save the selected parameter and return to the previous menu. In parameter selection edit interface, press key to maintain the parameter value and return to the previous menu.

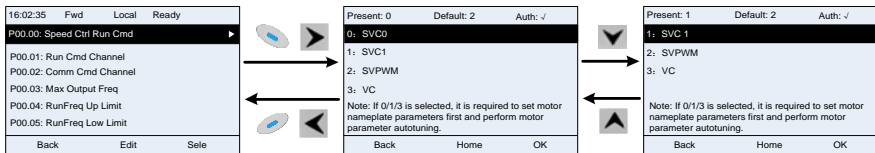

Figure 5-15 Editing user defined parameters

In parameter selection edit interface, the "Auth" field on the top right indicates whether this parameter is editable or not.

"√" indicates the set value of this parameter can be modified under the present state.

"x" indicates the set value of this parameter cannot be modified under the present state.



"Present" indicates the present value.

"Default" indicates the default value of this parameter.

### 5.4.6 Editing parameters in parameter groups

You can choose **Menu > Parameter groups**, enter a specific function group and then a specific function code, and then press key, key or key to enter the parameter setting interface. After entering the edit interface, set the parameter from the low bit to high bit, and the bit under setting will be highlighted. Press key or key to increase or decrease the parameter value (this operation is valid until the parameter value exceeds the max. value or min. value); press or to shift the edit bit. After the parameter is set, press key or key to save the setting and return to the previous menu; press to maintain the original parameter value and return to the previous menu.

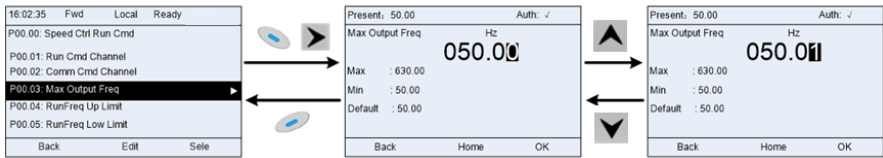

Figure 5-16 Editing parameters in parameter groups

In the parameter edit interface, the "Auth" field on the top right indicates whether this parameter can be modified or not.

"✓" indicates the set value of this parameter can be modified under the present state.

"×" indicates the set value of this parameter cannot be modified under the present state.

"Present" indicates the present value.

"Default" indicates the default value of this parameter.

### 5.4.7 Monitoring states

You can choose **Menu > State monitoring > State monitoring parameter**, enter a specific function group and then a specific function code, and press key, key or key to enter the state monitoring interface. After entering the state monitoring interface, the actual parameter value will be displayed in real time, this value is the actually detected value which cannot be modified.

In the state monitoring interface, you can press key or key to return to the previous menu.

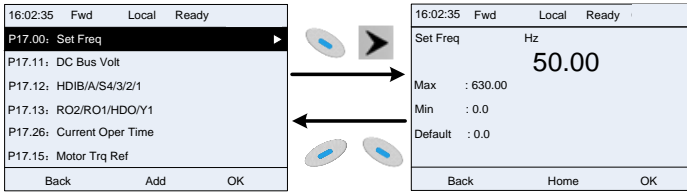

Figure 5-17 State monitoring interface

### 5.4.8 Autotuning motor parameters

You can choose **Menu > Motor parameter autotune** and press key, key or key to enter motor parameter autotuning interface, however, before entering motor parameter autotuning interface, you must set the motor nameplate parameters correctly. After entering the interface, select motor autotuning type to carry out motor parameter autotuning. In motor parameter autotuning interface, you can press key or key to return to the previous menu.

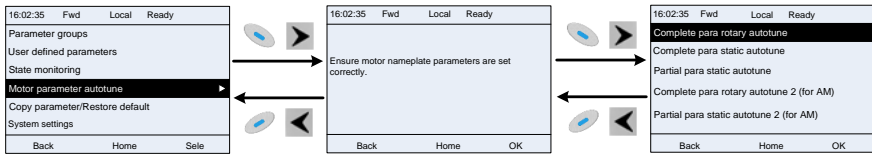

Figure 5-18 Selecting a parameter autotuning type.

After selecting a motor autotuning type, enter the motor parameter autotuning interface, and press **RUN** key to start motor parameter autotuning. After autotuning is done, a message will pop out indicating autotuning is successful, and then it will return to the main interface of stop. During autotuning, you can press **STOP/RSI** key to terminate autotuning; if any fault occurs during autotuning, the keypad will display a fault interface.

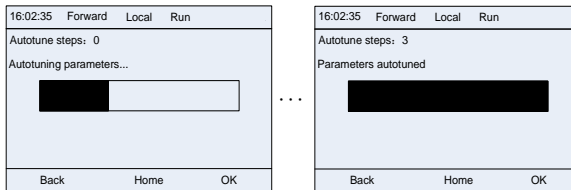

Figure 5-19 Parameter autotuning

### 5.4.9 Backing up parameters

You can choose **Menu > Copy parameter/Restore default**, and press key, key or key to enter function parameter backup interface and function parameter restoration setting interface to upload/download VFD parameters or restore VFD parameters to default value. The keypad has three different storage areas for parameter backup, and each storage area can save the parameters of one VFD, which means the keypad can save parameters of three VFD in total.

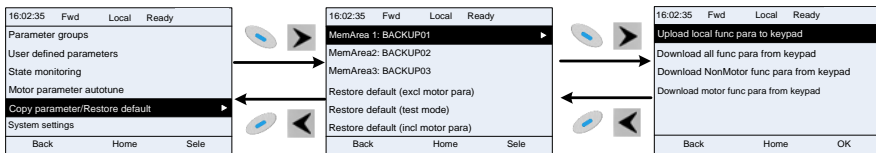

Figure 5-20 Parameter backup

**5.4.10 System settings**

You can choose **Menu > System settings**, and press key, key or key to enter system setting interface to set the keypad language, time/date, backlight brightness, backlight time and restore parameters.

**Note:** Clock battery is not included, and the keypad time/date needs to be reset after power off. If timekeeping after power off is needed, you need to purchase the clock batteries separately.

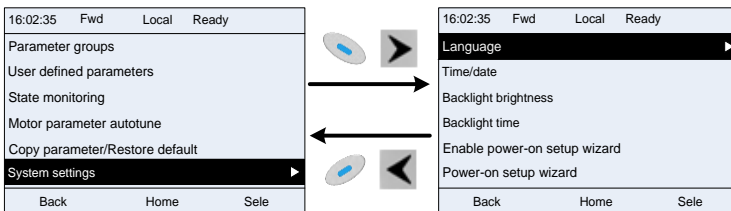
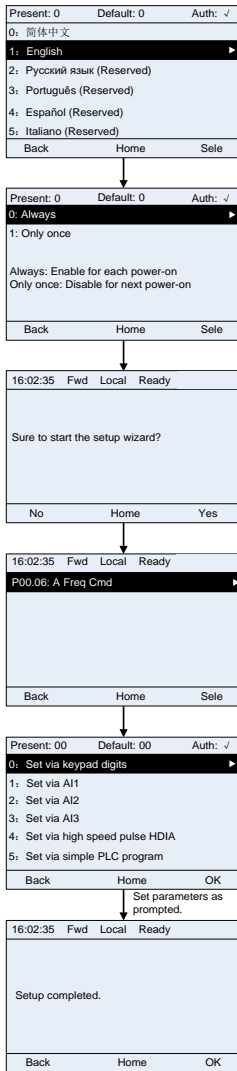

Figure 5-21 System settings

**5.4.11 Power-on setup wizard**

The keypad supports the power-on setup wizard function, mainly for the first power-on situation, instructing you to enter the setting menu, and gradually implementing basic functions such as basic parameter setting, direction judgment, mode setting and autotuning.

For first power-on, the keypad automatically enters the setup wizard interface. See the following.



If you want to change the wizard settings, you can **Menu > System settings**, and then choose **Enable power-on setup wizard** or **Power-on setup wizard**, and then make changes.

## 5.5 Basic operation instruction

### 5.5.1 What this section contains

This section introduces the function modules inside the VFD.



- ◇ Ensure all the terminals are fixed and tightened firmly.
- ◇ Ensure the motor matches with the VFD power.

### 5.5.2 Common commissioning procedure

The common operation procedure is as follows (taking motor 1 as an example).

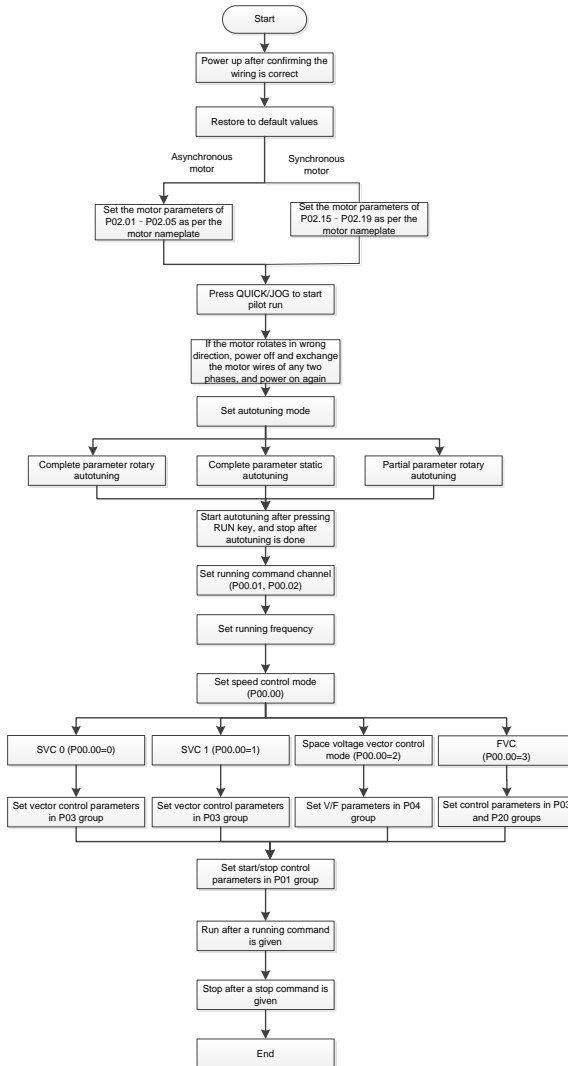

**Note:** If fault occurred, rule out the fault cause according to 7 Troubleshooting.

The running command channel can be set by terminal commands besides P00.01 and P00.02.

Current running command channel P00.01	Multifunction terminal function 36 Command switched to keypad	Multifunction terminal function 37 Command switched to terminal	Multifunction terminal function 38 Command switched to communication
Keypad	/	Terminal	Communication

Current running command channel P00.01	Multifunction terminal function 36 Command switched to keypad	Multifunction terminal function 37 Command switched to terminal	Multifunction terminal function 38 Command switched to communication
Terminal	Keypad	/	Communication
Communication	Keypad	Terminal	/

**Note:** "/" means this multifunction terminal is invalid under current reference channel.

Related parameter list:

Function code	Name	Detailed parameter description	Default value
P00.00	Speed control mode	0: SVC 0 1: SVC 1 2: SVPWM 3: FVC <b>Note:</b> If 0, 1 or 3 is selected, it is required to carry out motor parameter autotuning first.	2
P00.01	Running command channel	0: Keypad 1: Terminal 2: Communication	0
P00.02	Communication running command channel	0: Modbus/Modbus TCP 1: CANopen 2: Ethernet 3: EtherCAT/PROFINET/EtherNet IP 4: Programmable card 5: Wireless communication card	0
P00.15	Motor parameter autotuning	0: No operation 1: Complete rotary parameter autotuning 2: Complete static parameter autotuning 3: Partial static parameter autotuning 4: Complete rotary parameter autotuning 2 (for asynchronous motors) 5: Partial static parameter autotuning 2 (for asynchronous motors)	0
P00.18	Function parameter restoration	0: No operation 1: Restore default values (excluding motor parameters) 2: Clear fault records 3: Lock keypad parameters 4: Reserved	0

Function code	Name	Detailed parameter description	Default value
		5: Restore default values (for factory test mode) 6: Restore default values (including motor parameters) <b>Note:</b> After the selected operation is done, this parameter is automatically restored to 0. Restoring the default values may delete the user password. Exercise caution when using this function. The option 5 can be used only for factory testing.	
P02.00	Type of motor 1	0: Asynchronous motor 1: Synchronous motor	0
P02.01	Rated power of asynchronous motor 1	0.1–3000.0kW	Depends on model
P02.02	Rated frequency of asynchronous motor 1	0.01Hz–P00.03 (Max. output frequency)	60.00Hz
P02.03	Rated speed of asynchronous motor 1	1–60000rpm	1700rpm
P02.04	Rated voltage of asynchronous motor 1	0–1200V	Depends on model
P02.05	Rated current of asynchronous motor 1	0.8–6000.0A	Depends on model
P02.15	Rated power of synchronous motor 1	0.1–3000.0kW	Depends on model
P02.16	Rated frequency of synchronous motor 1	0.01Hz–P00.03 (Max. output frequency)	60.00Hz
P02.17	Number of pole pairs of synchronous motor 1	1–50	2
P02.18	Rated voltage of synchronous motor 1	0–1200V	Depends on model
P02.19	Rated current of synchronous motor 1	0.8–6000.0A	Depends on model
P05.01–P05.06	Function of multifunction digital input terminal (S1–S4, HDIA, HDIB)	36: Command switches to keypad 37: Command switches to terminal 38: Command switches to communication	/
P07.01	Reserved	/	/
P07.02	<b>QUICK/JOG</b> key function	Range: 0x00–0x27 Ones: <b>QUICK/JOG</b> key function selection	0x01



Function code	Name	Detailed parameter description	Default value
		0: No function 1: Jogging 2: Reserved 3: Switching between forward/reverse rotation 4: Clear <b>UP/DOWN</b> setting 5: Coast to stop 6: Switch running command reference mode by sequence 7: Reserved Tens: Reserved	

**5.5.3 Vector control**

Asynchronous motors are featured with high order, non-linear, strong coupling, and multi-variables, which makes it very difficult to control asynchronous motors during actual application. The vector control theory aims to solve this problem through measuring and controlling the stator current vector of asynchronous motor, and decomposing the stator current vector into exciting current (current component which generates internal magnet field) and torque current (current component which generates torque) based on field orientation principle, and then controlling the amplitude value and phase position of these two components (namely, control the stator current vector of motor) to realize decoupling control of exciting current and torque current, thus achieving high-performance speed regulation of asynchronous motor.

The UMI-B7 series VFD carries a built-in speed sensor-less vector control algorithm, which can be used to drive the asynchronous motor and permanent-magnet synchronous motor simultaneously. As the core algorithm of vector control is based on accurate motor parameter model, the accuracy of motor parameters will impact the control performance of vector control. It is recommended to input accurate motor parameters and carry out motor parameter autotuning before vector operation.

As vector control algorithm is complicated, you should be cautious of regulation on dedicated function parameters of vector control.

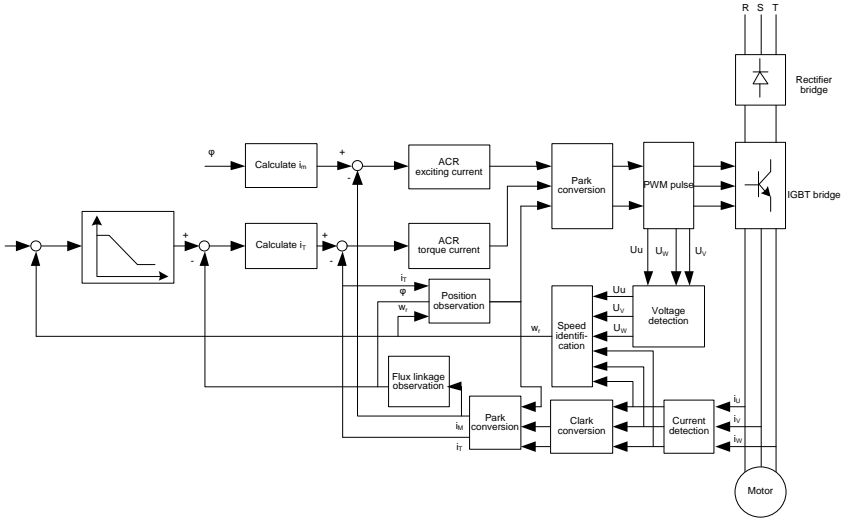

Function code	Name	Detailed parameter description	Default value
P00.00	Speed control mode	0: SVC 0 1: SVC 1 2: SVPWM 3: FVC <b>Note:</b> If 0, 1 or 3 is selected, it is required to carry out motor parameter autotuning first.	2
P00.15	Motor parameter autotuning	0: No operation 1: Complete rotary parameter autotuning 2: Complete static parameter autotuning 3: Partial static parameter autotuning 4: Complete rotary parameter autotuning 2 (for asynchronous motors) 5: Partial static parameter autotuning 2 (for asynchronous motors)	0
P02.00	Type of motor 1	0: Asynchronous motor 1: Synchronous motor	0
P03.00	Speed loop proportional gain 1	0–200.0	20.0
P03.01	Speed loop integral time 1	0.000–10.000s	0.200s

Function code	Name	Detailed parameter description	Default value
P03.02	Switching low point frequency	0.00Hz–P03.05	5.00Hz
P03.03	Speed loop proportional gain 2	0–200.0	20.0
P03.04	Speed loop integral time 2	0.000–10.000s	0.200s
P03.05	Switching high point frequency	P03.02–P00.03 (Max. output frequency)	10.00Hz
P03.06	Speed loop output filter	0–8 (corresponds to 0–2 <sup>8</sup> /10ms)	0
P03.07	Electromotion slip compensation coefficient of vector control	50%–200%	100%
P03.08	Brake slip compensation coefficient of vector control	50%–200%	100%
P03.09	Current loop proportional coefficient P	0–65535	1000
P03.10	Current loop integral coefficient I	0–65535	1000
P03.11	Torque setting source selection	0: Keypad (P03.12) 1: Keypad (P03.12) 2: AI1 3: AI2 4: AI3 5: Pulse frequency HDIA 6: Multi-step torque 7: Modbus/Modbus TCP communication 8: CANopen communication 9: Ethernet communication 10: Pulse frequency HDIB 11: EtherCAT/PROFINET/EtherNet IP communication 12: Programmable card <b>Note:</b> For these settings, 100% corresponds to the motor rated current.	0
P03.12	Torque set through keypad	-300.0%–300.0% (of the motor rated current)	50.0%
P03.13	Torque reference filter time	0.000–10.000s	0.010s

Function code	Name	Detailed parameter description	Default value
P03.14	Setting source of FWD rotation frequency upper limit in torque control	0: Keypad (P03.16) 1: AI1 2: AI2 3: AI3 4: Pulse frequency HDIA 5: Multi-step setting 6: Modbus/Modbus TCP communication 7: CANopen communication 8: Ethernet communication 9: Pulse frequency HDIB 10: EtherCAT/PROFINET/EtherNet IP communication 11: Programmable card 12: Reserved <b>Note:</b> For these settings, 100% corresponds to the max. frequency.	0
P03.15	Setting source of REV rotation frequency upper limit in torque control	0: Keypad (P03.17) 1–11: the same as P03.14	0
P03.16	FWD rotation frequency upper limit set through keypad in torque control	Value range: 0.00 Hz–P00.03 (Max. output frequency)	60.00Hz
P03.17	REV rotation frequency upper limit set through keypad in torque control		60.00Hz
P03.18	Setting source of electromotive torque upper limit	0: Keypad (P03.20) 1: AI1 2: AI2 3: AI3 4: Pulse frequency HDIA 5: Modbus/Modbus TCP communication 6: CANopen communication 7: Ethernet communication 8: Pulse frequency HDIB 9: EtherCAT/PROFINET/EtherNet IP communication 10: PLC 11: Reserved	0

Function code	Name	Detailed parameter description	Default value
		<b>Note:</b> For these settings, 100% corresponds to the rated motor current.	
P03.19	Setting source of braking torque upper limit	0: Keypad (P03.21) 1–10: the same as P03.18	0
P03.20	Electromotive torque upper limit set through keypad	0.0–300.0% (of the motor rated current)	180.0%
P03.21	Braking torque upper limit set through keypad		180.0%
P03.22	Flux-weakening coefficient in constant power area	0.1–2.0	0.3
P03.23	Min. flux-weakening point in constant power area	10%–100%	20%
P03.24	Max. voltage limit	0.0–120.0%	100.0%
P03.25	Pre-exciting time	0.000–10.000s	0.300s
P03.32	Enabling torque control	0: Disable 1: Enable	0
P03.33	Flux weakening integral gain	0–8000	1200
P03.35	Control optimization setting	Ones place: Torque command selection 0: Torque reference 1: Torque current reference Tens place: Reserved 0: Reserved 1: Reserved Hundreds place: Whether to enable ASR integral separation 0: Disable 1: Enable Thousands place: Reserved 0: Reserved 1: Reserved Range: 0x0000–0x1111	0x0000
P03.36	ASR differential gain	0.00–10.00s	0.00s
P03.37	High-frequency ACR proportional coefficient	In FVC (P00.00=3), when the frequency is lower than the ACR high-frequency switching threshold (P03.39), the ACR PI parameters are P03.09 and P03.10; and	1000
P03.38	High-frequency ACR integral coefficient		1000

Function code	Name	Detailed parameter description	Default value
P03.39	ACR high frequency switching threshold	when the frequency is higher than the ACR high-frequency switching threshold (P03.39), the ACR PI parameters are P03.37 and P03.38. Setting range of P03.37: 0–65535 Setting range of P03.38: 0–65535 Setting range of P03.39: 0.0–100.0% (in relative to the maximum frequency)	100.0%
P17.32	Flux linkage	0.0–200.0%	0.0%

**5.5.4 SVPWM control mode**

UMI-B7 VFD also carries built-in SVPWM control function. SVPWM mode can be used in cases where mediocre control precision is enough. In cases where a VFD needs to drive multiple motors, it is also recommended to adopt SVPWM control mode.

UMI-B7 VFD provides multiple kinds of V/F curve modes to meet different field needs. You can select corresponding V/F curve or set the V/F curve as needed.

**Suggestions:**

- For the load featuring constant moment, such as conveyor belt which runs in straight line, as the moment should be constant during the whole running process, it is recommended to adopt straight-type V/F curve.
- For the load featuring decreasing moment, such as fan and water pump, as the relation between its actual torque and speed is squared or cubed, it is recommended to adopt the V/F curve corresponds to power of 1.3, 1.7 or 2.0.

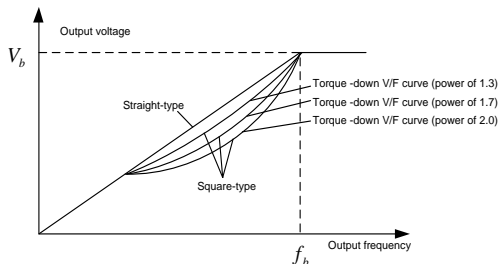

UMI-B7 VFD also provides multi-point V/F curve. You can alter the V/F curve output by VFD through setting the voltage and frequency of the three points in the middle. The whole curve consists of five points starting from (0Hz, 0V) and ending in (fundamental motor frequency, rated motor voltage). During setting, it is required that  $0 \leq f_1 \leq f_2 \leq f_3 \leq \text{fundamental motor frequency}$ , and  $0 \leq V_1 \leq V_2 \leq V_3 \leq \text{rated motor voltage}$ .

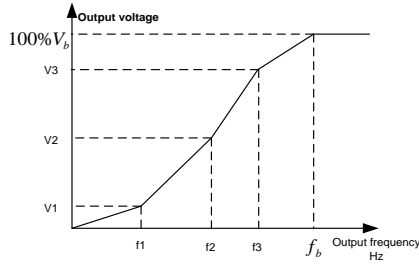

UMI-B7 VFD provides dedicated function codes for SVPWM control mode. You can improve the performance of SVPWM through settings.

1. Torque boost

Torque boost function can effectively compensate for the low-speed torque performance during SVPWM control. Automatic torque boost has been set by default to enable the VFD to adjust the torque boost value based on actual load conditions.

**Note:**

- (1) Torque boost is effective only under torque boost cut-off frequency.
- (2) If the torque boost is too large, low-frequency vibration or overcurrent may occur to the motor, if such situation occurs, lower the torque boost value.

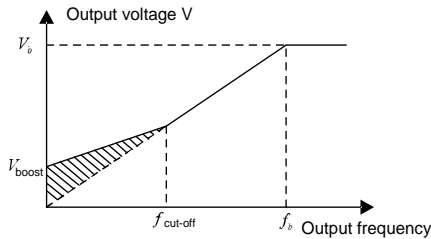

2. Energy-saving run

During actual running, the VFD can search for the maximum efficiency point to keep running in the most efficient state to save energy.

**Note:**

- (1) This function is generally used in light load or no-load cases.
- (2) This function does not fit in cases where load transient is required.

3. V/F slip compensation gain

SVPWM control belongs to open-loop mode, which will cause motor speed to fluctuate when motor load transients. In cases where strict speed requirement is needed, you can set the slip compensation gain to compensate for the speed variation caused by load fluctuation through internal output adjustment of VFD.

**The set range of slip compensation gain is 0–200%, in which 100% corresponds to rated slip frequency.**

**Note:** Rated slip frequency= (Rated synchronous speed of motor - Rated speed of motor) × Number of motor pole pairs/60

#### 4. Oscillation control

Motor oscillation often occurs in SVPWM control in large-power drive applications. To solve this problem, the UMI-B7 series VFD sets two function codes to control the oscillation factor, and you can set the corresponding function code based on the occurrence frequency of oscillation.

**Note:** The larger the set value, the better the control effect, however, if the set value is too large, it may easily lead to too large VFD output current.

#### 5. Asynchronous motor IF control

Generally, the IF control mode is valid for asynchronous motors. It can be used for a synchronous motor only when the frequency of the synchronous motor is extremely low. Therefore, the IF control described in this manual is only involved with asynchronous motors. IF control is implemented by performing closed-loop control on the total output current of the VFD. The output voltage adapts to the current reference, and open-loop control is separately performed over the frequency of the voltage and current.

Customized V/F curve (V/F separation) function:



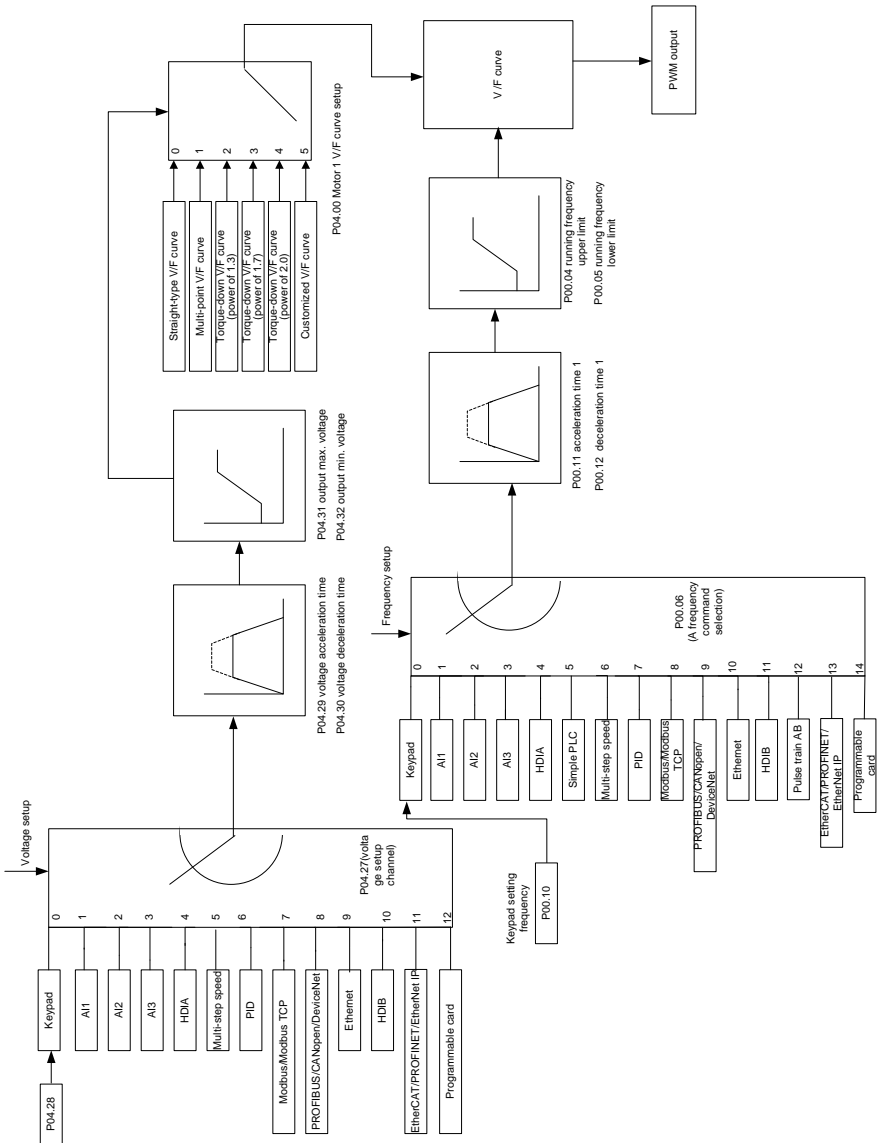

When selecting customized V/F curve function, you can set the reference channels and acceleration/deceleration time of voltage and frequency respectively, which will form a real-time V/F curve through combination.

**Note:** This kind of V/F curve separation can be applied in various frequency-conversion power sources, however, you should be cautious of parameter setting as improper setting may damage the machine.

Function code	Name	Detailed parameter description	Default value
P00.00	Speed control mode	0: SVC 0 1: SVC 1 2: SVPWM 3: FVC <b>Note:</b> If 0, 1 or 3 is selected, it is required to carry out motor parameter autotuning first.	2
P00.03	Max. output frequency	Max.(P00.04, 10.00) – 630.00Hz	60.00Hz
P00.04	Upper limit of running frequency	P00.05–P00.03	60.00Hz
P00.05	Lower limit of running frequency	0.00Hz–P00.04	0.00Hz
P00.11	Acceleration time 1	0.0–3600.0s	Depends on model
P00.12	Deceleration time 1	0.0–3600.0s	Depends on model
P02.00	Type of motor 1	0: Asynchronous motor 1: Synchronous motor	0
P02.02	Rated power of asynchronous motor 1	0.01Hz–P00.03 (Max. output frequency)	60.00Hz
P02.04	Rated voltage of asynchronous motor 1	0–1200V	Depends on model
P04.00	V/F curve setting of motor 1	0: Straight-type V/F curve 1: Multi-point V/F curve 2: Torque-down V/F curve (power of 1.3) 3: Torque-down V/F curve (power of 1.7) 4: Torque-down V/F curve (power of 2.0) 5: Customized V/F (V/F separation)	0
P04.01	Torque boost of motor 1	0.0%: (automatic); 0.1%–10.0%	0.0%
P04.02	Motor 1 torque boost cut-off	0.0%–50.0% (rated frequency of motor 1)	20.0%
P04.03	V/F frequency point 1 of motor 1	0.00Hz–P04.05	0.00Hz
P04.04	V/F voltage point 1 of motor 1	0.0%–110.0%	0.0%

Function code	Name	Detailed parameter description	Default value
P04.05	V/F frequency point 2 of motor 1	P04.03–P04.07	0.00Hz
P04.06	V/F voltage point 2 of motor 1	0.0%–110.0%	0.0%
P04.07	V/F frequency point 3 of motor 1	P04.05–P02.02 or P04.05–P02.16	0.00Hz
P04.08	V/F voltage point 3 of motor 1	0.0%–110.0%	0.0%
P04.09	V/F slip compensation gain of motor 1	0.0–200.0%	100.0%
P04.10	Low-frequency oscillation control factor of motor 1	0–100	10
P04.11	High-frequency oscillation control factor of motor 1	0–100	10
P04.12	Oscillation control threshold of motor 1	0.00Hz–P00.03 (Max. output frequency)	30.00Hz
P04.13	V/F curve setting of motor 2	0: Straight V/F curve 1: Multi-point V/F curve 2: Torque-down V/F curve (power of 1.3) 3: Torque-down V/F curve (power of 1.7) 4: Torque-down V/F curve (power of 2.0) 5: Customize V/F (V/F separation)	0
P04.14	Torque boost of motor 2	0.0%: (automatic); 0.1%–10.0%	0.0%
P04.15	Torque boost cut-off of motor 2	0.0%–50.0% (rated frequency of motor 1)	20.0%
P04.16	V/F frequency point 1 of motor 2	0.00Hz–P04.18	0.00Hz
P04.17	V/F voltage point 1 of motor 2	0.0%–110.0%	0.0%
P04.18	V/F frequency point 2 of motor 2	P04.16–P04.20	0.00Hz
P04.19	V/F voltage point 2 of motor 2	0.0%–110.0%	0.0%
P04.20	V/F frequency point 3 of motor 2	P04.18–P02.02 or P04.18–P02.16	0.00Hz

Function code	Name	Detailed parameter description	Default value
P04.21	V/F voltage point 3 of motor 2	0.0%–110.0%	0.0%
P04.22	V/F slip compensation gain of motor 2	0.0–200.0%	100.0%
P04.23	Low-frequency oscillation control factor of motor 2	0–100	10
P04.24	High-frequency oscillation control factor of motor 2	0–100	10
P04.25	Oscillation control threshold of motor 2	0.00Hz–P00.03 (Max. output frequency)	30.00Hz
P04.26	Energy-saving run	0: No 1: Automatic energy-saving run	0
P04.27	Channel of voltage setting	0: Keypad; output voltage is determined by P04.28 1: AI1 2: AI2 3: AI3 4: HDIA 5: Multi-step 6: PID 7: Modbus/Modbus TCP communication 8: CANopen communication 9: Ethernet communication 10: HDIB 11: EtherCAT/PROFINET/EtherNet IP 12: Programmable card 13: Reserved	0
P04.28	Set voltage value via keypad	0.0%–100.0% (of rated motor voltage)	100.0%
P04.29	Voltage increase time	0.0–3600.0s	5.0s
P04.30	Voltage decrease time	0.0–3600.0s	5.0s
P04.31	Output max. voltage	P04.32–100.0% (of rated motor voltage)	100.0%
P04.32	Output min. voltage	0.0%–P04.31 (rated motor voltage)	0.0%
P04.33	Flux-weakening coefficient in the constant power zone	1.00–1.30	1.00

Function code	Name	Detailed parameter description	Default value
P04.34	Pull-in current 1 in synchronous motor VF control	When the synchronous motor VF control mode is enabled, this parameter is used to set the reactive current of the motor when the output frequency is lower than the frequency set in P04.36. Setting range: -100.0%~+100.0% (of the rated current of the motor)	20.0%
P04.35	Pull-in current 2 in synchronous motor VF control	When the synchronous motor VF control mode is enabled, this parameter is used to set the reactive current of the motor when the output frequency is higher than the frequency set in P04.36. Setting range: -100.0%~+100.0% (of the rated current of the motor)	10.0%
P04.36	Frequency threshold for pull-in current switching in synchronous motor VF control	When the synchronous motor VF control mode is enabled, this parameter is used to set the frequency threshold for the switching between pull-in current 1 and pull-in current 2. Setting range: 0.0%~200.0% (of the motor rated frequency)	20.0%
P04.37	Reactive current closed-loop proportional coefficient in synchronous motor VF control	When the synchronous motor VF control mode is enabled, this parameter is used to set the proportional coefficient of the reactive current closed-loop control. Setting range: 0~3000	50
P04.38	Reactive current closed-loop integral time in synchronous motor VF control	When the synchronous motor VF control mode is enabled, this parameter is used to set the integral coefficient of the reactive current closed-loop control. Setting range: 0~3000	30
P04.39	Reactive current closed-loop output limit in synchronous motor VF control	When the synchronous motor VF control mode is enabled, this parameter is used to set the output limit of the reactive current closed-loop control. A greater value indicates a higher reactive closed-loop compensation voltage and higher output power of the motor. In general, you do not need to modify this parameter. Setting range: 0~16000	8000
P04.40	Enable/disable IF mode for	0: Disabled 1: Enabled	0

Function code	Name	Detailed parameter description	Default value
	asynchronous motor 1		
P04.41	Current setting in IF mode for asynchronous motor 1	When IF control is adopted for asynchronous motor 1, this parameter is used to set the output current. The value is a percentage relative to the rated current of the motor. Setting range: 0.0–200.0%	120.0%
P04.42	Proportional coefficient in IF mode for asynchronous motor 1	When IF control is adopted for asynchronous motor 1, this parameter is used to set the proportional coefficient of the output current closed-loop control. Setting range: 0–5000	350
P04.43	Integral coefficient in IF mode for asynchronous motor 1	When IF control is adopted for asynchronous motor 1, this parameter is used to set the integral coefficient of the output current closed-loop control. Setting range: 0–5000	150
P04.44	Starting frequency point for switching off IF mode for asynchronous motor 1	Setting range: 0.00–P04.50	10.00Hz
P04.45	Enable/disable IF mode for asynchronous motor 2	0: Disabled 1: Enabled	0
P04.46	Current setting in IF mode for asynchronous motor 2	When IF control is adopted for asynchronous motor 2, this parameter is used to set the output current. The value is a percentage relative to the rated current of the motor. Setting range: 0.0–200.0%	120.0%
P04.47	Proportional coefficient in IF mode for asynchronous motor 2	When IF control is adopted for asynchronous motor 2, this parameter is used to set the proportional coefficient of the output current closed-loop control. Setting range: 0–5000	350
P04.48	Integral coefficient in IF mode for asynchronous motor 2	When IF control is adopted for asynchronous motor 2, this parameter is used to set the integral coefficient of the output current closed-loop control. Setting range: 0–5000	150
P04.49	Starting frequency point for switching off	Setting range: 0.00–P04.51	10.00Hz

Function code	Name	Detailed parameter description	Default value
	IF mode for asynchronous motor 2		
P04.50	End frequency point for switching off IF mode for asynchronous motor 1	P04.44–P00.03	25.00Hz
P04.51	End frequency point for switching off IF mode for asynchronous motor 2	P04.49–P00.03	25.00Hz

**5.5.5 Torque control**

The UMI-B7 VFD supports torque control and speed control. Speed control mode aims to stabilize the speed to keep the set speed consistent with the actual running speed. Meanwhile, the max. load-carrying capacity is restricted by torque limit. Torque control mode aims to stabilize the torque to keep the set torque consistent with the actual output torque, meanwhile, the output frequency is restricted by upper/lower limit.

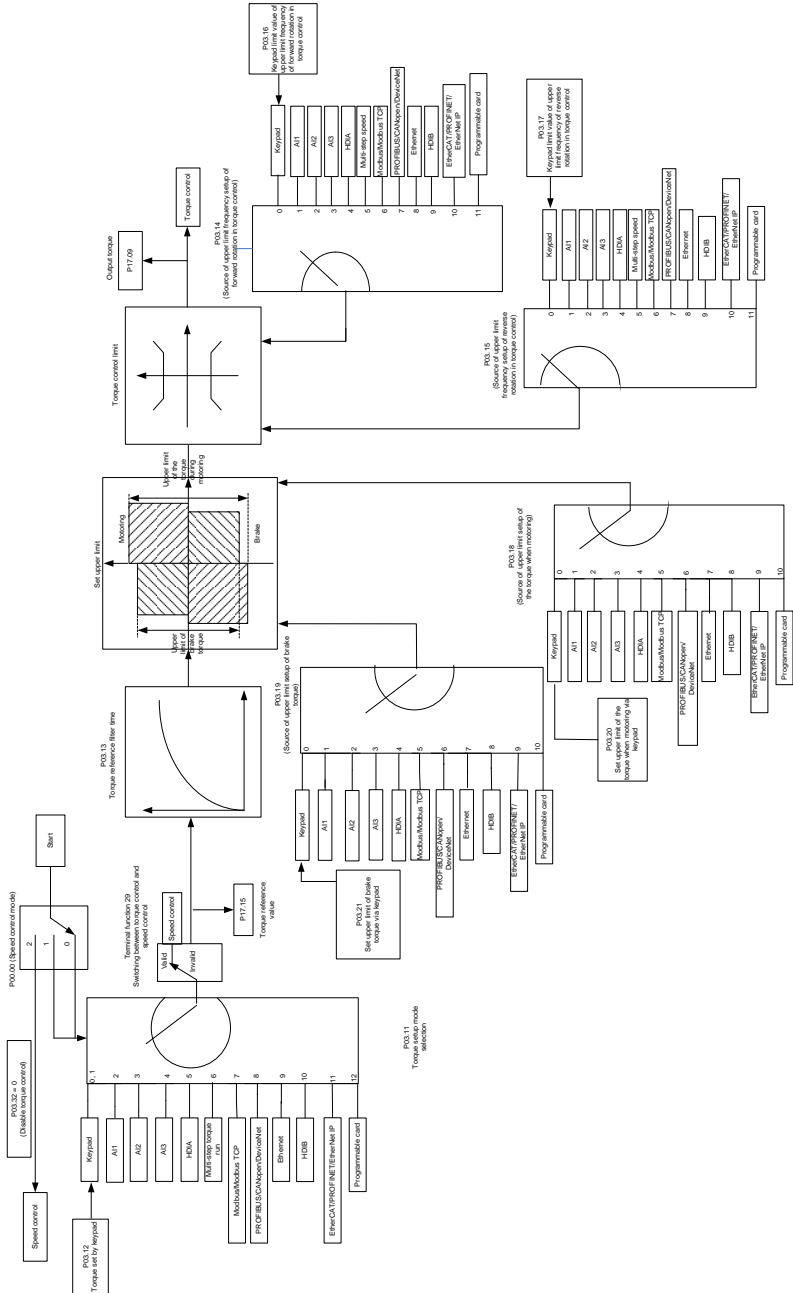





Function code	Name	Detailed parameter description	Default value
P00.00	Speed control mode	0: SVC 0 1: SVC 1 2: SVPWM 3: FVC <b>Note:</b> If 0, 1 or 3 is selected, it is required to carry out motor parameter autotuning first.	2
P03.32	Enabling torque control	0: Disable 1: Enable	0
P03.11	Torque setting mode selection	0: Keypad (P03.12) 1: Keypad (P03.12) 2: AI1 3: AI2 4: AI3 5: Pulse frequency HDIA 6: Multi-step torque 7: Modbus/Modbus TCP communication 8: CANopen communication 9: Ethernet communication 10: Pulse frequency HDIB 11: EtherCAT/PROFINET/EtherNet IP communication 12: Programmable card <b>Note:</b> For these settings, 100% corresponds to the motor rated current.	0
P03.12	Torque set through keypad	-300.0%–300.0% (of the motor rated current)	50.0%
P03.13	Torque reference filter time	0.000–10.000s	0.010s
P03.14	Setting source of FWD rotation frequency upper limit in torque control	0: Keypad (P03.16) 1: AI1 2: AI2 3: AI3 4: Pulse frequency HDIA 5: Multi-step setting 6: Modbus/Modbus TCP communication 7: CANopen communication 8: Ethernet communication 9: Pulse frequency HDIB	0

Function code	Name	Detailed parameter description	Default value
		10: EtherCAT/PROFINET/EtherNet IP communication 11: Programmable card 12: Reserved <b>Note:</b> For these settings, 100% corresponds to the max. frequency.	
P03.15	Setting source of REV rotation frequency upper limit in torque control	0: Keypad (P03.17) 1: AI1 2: AI2 3: AI3 4: Pulse frequency HDIA 5: Multi-step setting 6: Modbus/Modbus TCP communication 7: CANopen communication 8: Ethernet communication 9: Pulse frequency HDIB 10: EtherCAT/PROFINET/EtherNet IP communication 11: Programmable card 12: Reserved <b>Note:</b> For these settings, 100% corresponds to the max. frequency.	0
P03.16	FWD rotation frequency upper limit set through keypad in torque control	0.00Hz–P00.03 (Max. output frequency)	60.00 Hz
P03.17	REV rotation frequency upper limit set through keypad in torque control	0.00Hz–P00.03 (Max. output frequency)	60.00 Hz
P03.18	Setting source of electromotive torque upper limit	0: Keypad (P03.20) 1: AI1 2: AI2 3: AI3 4: Pulse frequency HDIA 5: Modbus/Modbus TCP communication 6: CANopen communication	0

Function code	Name	Detailed parameter description	Default value
		7: Ethernet communication 8: Pulse frequency HDIB 9: EtherCAT/PROFINET/EtherNet IP communication 10: PLC 11: Reserved <b>Note:</b> For these settings, 100% corresponds to the rated motor current.	
P03.19	Setting source of braking torque upper limit	0: Keypad (P03.21) 1–11: Same as those for P03.18 <b>Note:</b> For these settings, 100% corresponds to the rated motor current.	0
P03.20	Electromotive torque upper limit set through keypad	0.0–300.0% (of rated motor current)	180.0%
P03.21	Braking torque upper limit set through keypad	0.0–300.0% (of rated motor current)	180.0%
P17.09	Motor output torque	-250.0–250.0%	0.0%
P17.15	Torque reference value	-300.0–300.0% (of rated motor current)	0.0%

**5.5.6 Motor parameter**

	<ul style="list-style-type: none"> <li>◇ Check the safety conditions surrounding the motor and load machinery before autotuning as physical injury may occur due to sudden start of motor during autotuning.</li> <li>◇ Although the motor does not run during static autotuning, the motor is still supplied with power, do not touch the motor during autotuning; otherwise, electric shock may occur.</li> </ul>
	<ul style="list-style-type: none"> <li>◇ If the motor has been connected to load, do not carry out rotary autotuning; otherwise, misact or damage may occur to the VFD. If rotary autotuning is carried out on a motor which has been connected to load, wrong motor parameters and motor misacts may occur. Disconnect the load to carry out autotuning if necessary.</li> </ul>

UMI-B7 VFD can drive asynchronous motors and synchronous motors, and it supports two sets of motor parameters, which can be switched over by multifunction digital input terminals or communication modes.

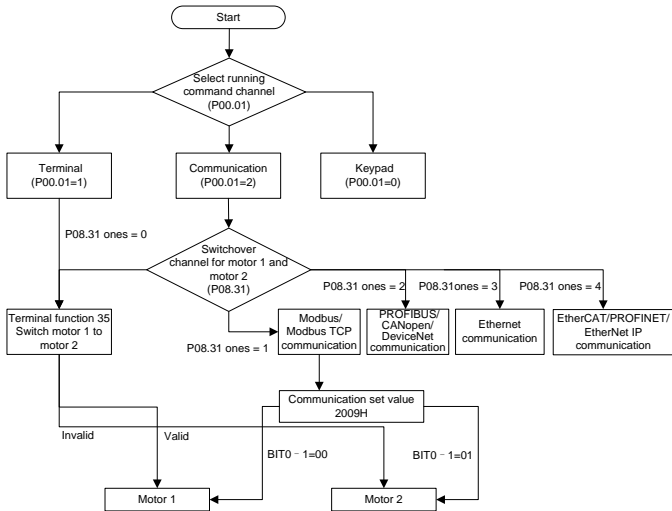

The control performance of the VFD is based on an accurate motor model; therefore, you need to carry out motor parameter autotuning before running the motor for the first time (taking motor 1 as an example).

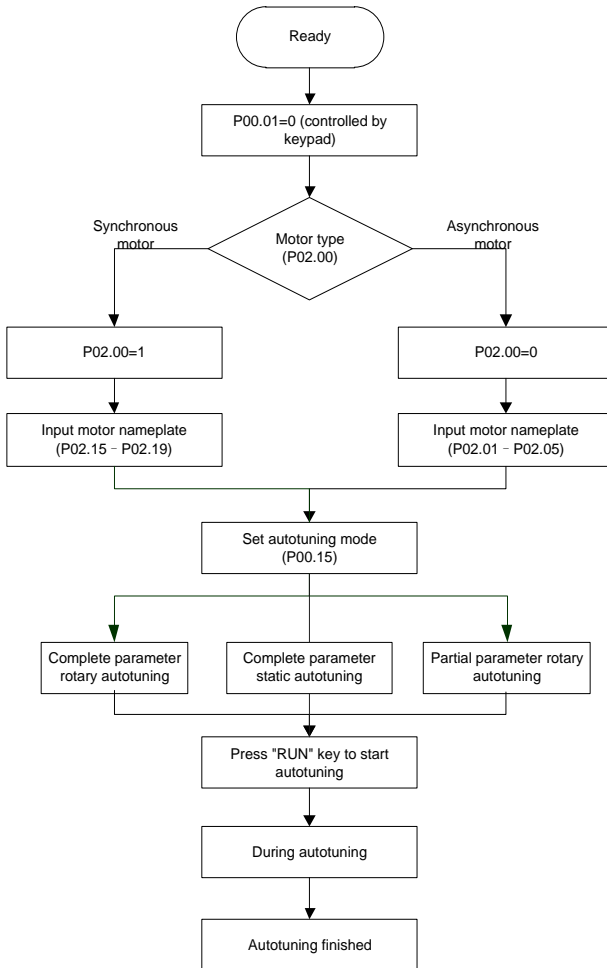

**Note:**

- Motor parameters must be set correctly according to motor nameplate.
- If rotary autotuning is selected during motor autotuning, it is a must to disconnect the motor from load to put the motor in static and no-load state, failed to do so may lead to inaccurate autotuned results. At this time, the asynchronous motor can autotune P02.06–P02.10, and synchronous motor can autotune P02.20–P02.23.
- If static autotuning is selected during motor autotuning, there is no need to disconnect the motor from load, as only part of the motor parameters have been autotuned, the control performance may be impacted, under such situation, the asynchronous motor can autotune P02.06–P02.10, while synchronous motor can autotune P02.20–P02.22, P02.23 (counter-emf constant of

synchronous motor 1) can be obtained via calculation.

- Motor autotuning can be carried out on current motor only. If you need to perform autotuning on the other motor, switch over the motor through selecting the switchover channel of motor 1 and motor 2 by setting the ones of P08.31.

Related parameter list:

Function code	Name	Detailed parameter description	Default value
P00.01	Running command channel	0: Keypad 1: Terminal 2: Communication	0
P00.15	Motor parameter autotuning	0: No operation 1: Complete rotary parameter autotuning 2: Complete static parameter autotuning 3: Partial static parameter autotuning 4: Complete rotary parameter autotuning 2 (for asynchronous motors) 5: Partial static parameter autotuning 2 (for asynchronous motors)	0
P02.00	Type of motor 1	0: Asynchronous motor 1: Synchronous motor	0
P02.01	Rated power of asynchronous motor 1	0.1–3000.0kW	Depends on model
P02.02	Rated frequency of asynchronous motor 1	0.01Hz–P00.03 (Max. output frequency)	60.00Hz
P02.03	Rated speed of asynchronous motor 1	1–60000rpm	1700rpm
P02.04	Rated voltage of asynchronous motor 1	0–1200V	Depends on model
P02.05	Rated current of asynchronous motor 1	0.8–6000.0A	Depends on model
P02.06	Stator resistance of asynchronous motor 1	0.001–65.535Ω	Depends on model
P02.07	Rotor resistance of asynchronous motor 1	0.001–65.535Ω	Depends on model
P02.08	Leakage inductance of asynchronous motor 1	0.1–6553.5mH	Depends on model
P02.09	Mutual inductance of asynchronous motor 1	0.1–6553.5mH	Depends on model
P02.10	No-load current of asynchronous motor 1	0.1–6553.5A	Depends on model

Function code	Name	Detailed parameter description	Default value
P02.15	Rated power of synchronous motor 1	0.1–3000.0kW	Depends on model
P02.16	Rated frequency of synchronous motor 1	0.01Hz–P00.03 (Max. output frequency)	60.00Hz
P02.17	Number of pole pairs of synchronous motor 1	1–50	2
P02.18	Rated voltage of synchronous motor 1	0–1200V	Depends on model
P02.19	Rated current of synchronous motor 1	0.8–6000.0A	Depends on model
P02.20	Stator resistance of synchronous motor 1	0.001–65.535Ω	Depends on model
P02.21	Direct-axis inductance of synchronous motor 1	0.01–655.35mH	Depends on model
P02.22	Quadrature-axis inductance of synchronous motor 1	0.01–655.35mH	Depends on model
P02.23	Counter-emf constant of synchronous motor 1	0–10000	300
P05.01–P05.06	Function of multifunction digital input terminal (S1–S4, HDIA, HDIB)	35: Motor 1 switches to motor 2	/
P08.31	Switching between motor 1 and motor 2	0x00–0x14 Ones: Switchover channel 0: Terminal 1: Modbus/Modbus TCP communication 2: CANopen communication 3: Ethernet communication 4: EtherCAT/PROFINET/EtherNet IP communication Tens: indicates whether to enable switchover during running 0: Disable 1: Enable	00
P12.00	Type of motor 2	0: Asynchronous motor 1: Synchronous motor	0
P12.01	Rated power of asynchronous motor 2	0.1–3000.0kW	Depends on model
P12.02	Rated frequency of	0.01Hz–P00.03 (Max. output frequency)	60.00Hz

Function code	Name	Detailed parameter description	Default value
	asynchronous motor 2		
P12.03	Rated speed of asynchronous motor 2	1–60000rpm	1700rpm
P12.04	Rated voltage of asynchronous motor 2	0–1200V	Depends on model
P12.05	Rated current of asynchronous motor 2	0.8–6000.0A	
P12.06	Stator resistance of asynchronous motor 2	0.001–65.535Ω	
P12.07	Rotor resistance of asynchronous motor 2	0.001–65.535Ω	
P12.08	Leakage inductance of asynchronous motor 2	0.1–6553.5mH	
P12.09	Mutual inductance of asynchronous motor 2	0.1–6553.5mH	
P12.10	No-load current of asynchronous motor 2	0.1–6553.5A	
P12.15	Rated power of synchronous motor 2	0.1–3000.0kW	
P12.16	Rated frequency of synchronous motor 2	0.01Hz–P00.03 (Max. output frequency)	60.00Hz
P12.17	Number of pole pairs of synchronous motor 2	1–50	2
P12.18	Rated voltage of synchronous motor 2	0–1200V	Depends on model
P12.19	Rated current of synchronous motor 2	0.8–6000.0A	Depends on model
P12.20	Stator resistance of synchronous motor 2	0.001–65.535Ω	Depends on model
P12.21	Direct-axis inductance of synchronous motor 2	0.01–655.35mH	Depends on model
P12.22	Quadrature-axis inductance of synchronous motor 2	0.01–655.35mH	Depends on model
P12.23	Counter-emf constant of synchronous motor 2	0–10000V	300V

**5.5.7 Start/stop control**

The start/stop control of the VFD is divided into three states: start after running command at power-up; start after restart-at-power-down function is effective; start after automatic fault reset. Descriptions



for these three start/stop control states are presented below.

There are three start modes for the VFD, which are start at starting frequency, start after DC braking, and start after speed-tracking. You can select the proper start mode based on field conditions.

For large-inertia load, especially in cases where reversal may occur, you can choose to start after DC braking or start after speed-racking.

**Note:** It is recommended to drive synchronous motors in direct start mode.

1. Logic diagram for running command after power-up

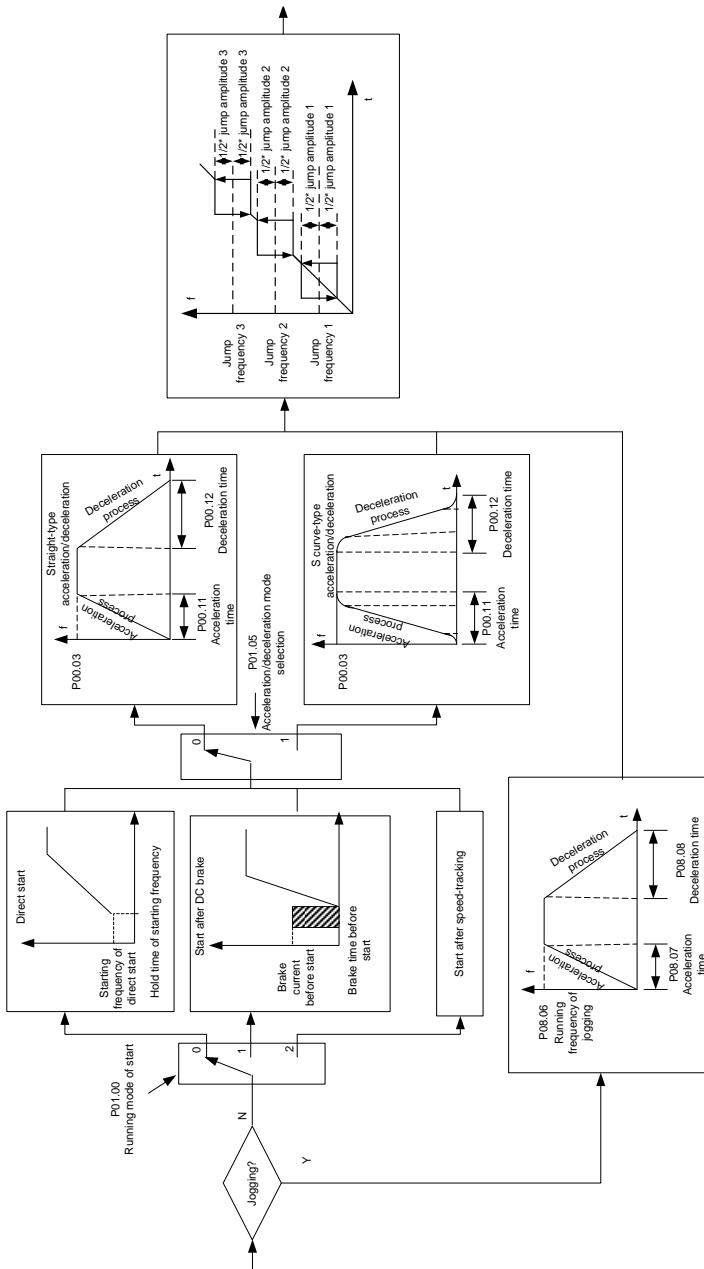

2. Logic diagram for restart after power-down

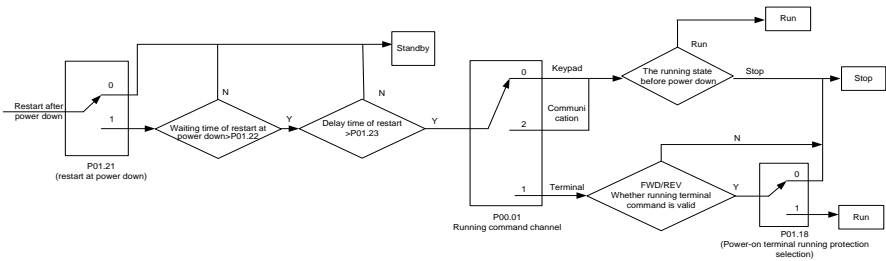

3. Logic diagram for restart after automatic fault reset.

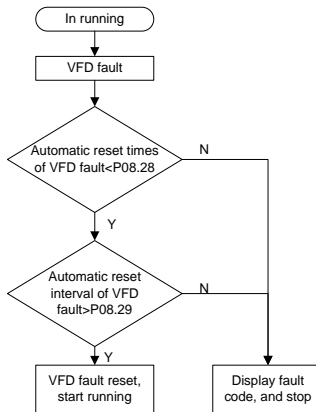

Related parameter list:

Function code	Name	Detailed parameter description	Default value
P00.01	Running command channel	0: Keypad 1: Terminal 2: Communication	0
P00.11	Acceleration time 1	0.0–3600.0s	Depends on model
P00.12	Deceleration time 1	0.0–3600.0s	Depends on model
P01.00	Running mode of start	0: Direct start 1: Start after DC braking 2: Start after speed-tracking (with excitation) 3: Start after speed-tracking (without excitation)	0
P01.01	Starting frequency of direct	0.00–50.00Hz	0.50Hz

Function code	Name	Detailed parameter description	Default value
	start		
P01.02	Hold time of starting frequency	0.0–50.0s	0.0s
P01.03	DC braking current before start	0.0–100.0%	0.0%
P01.04	DC braking time before start	0.00–50.00s	0.00s
P01.05	Acceleration/deceleration mode	0: Straight line 1: S curve <b>Note:</b> If mode 1 is selected, it is required to set P01.06, P01.07, P01.27 and P01.08 accordingly.	0
P01.08	Stop mode	0: Decelerate to stop 1: Coast to stop	0
P01.09	Starting frequency of DC braking after stop	0.00Hz–P00.03 (Max. output frequency)	0.00Hz
P01.10	Waiting time of DC braking after stop	0.00–50.00s	0.00s
P01.11	DC braking current of stop	0.0–100.0% (of rated VFD output current)	0.0%
P01.12	DC braking time of stop	0.00–50.00s	0.00s
P01.13	Dead zone time of forward/reverse rotation	0.0–3600.0s	0.0s
P01.14	Forward/reverse rotation switchover mode	0: switch over after zero frequency 1: switch over after starting frequency 2: switch over after passing stop speed and delay	0
P01.15	Stop speed	0.00–100.00Hz	0.50 Hz
P01.16	Stop speed detection mode	0: Set value of speed (the only detection mode valid in V/F mode) 1: Detection value of speed	1
P01.18	Power-on terminal running protection selection	0: Terminal running command is invalid at power up. Note that the value takes effect only when P01.21 is also set to 0. 1: Terminal running command is valid at power up.	0
P01.19	Action selected when running frequency less than frequency lower limit (valid	Setting range: 0x00–0x12 This parameter specifies the running status of VFD when the set frequency is	0x00

Function code	Name	Detailed parameter description	Default value
	when frequency lower limit greater than 0)	below the lower limit. Ones place: Action selection 0: Run in lower limit of the frequency 1: Stop 2: Sleep Tens place: Stop mode 0: Coast to stop 1: Decelerate to stop The VFD stops as set in the tens place if the action selection is stop or sleep when the set frequency is below the lower limit. The VFD resumes the running state automatically when the set frequency is above the lower limit again and this situation lasts for the time set by P01.20.	
P01.20	Wake-up-from-sleep delay	0.0–3600.0s (valid when the ones place of P01.19 is 2)	0.0s
P01.21	Restart after power down	0: Restart is disabled 1: Restart is enabled	0
P01.22	Waiting time of restart after power down	0.0–3600.0s (valid when P01.21 is 1)	1.0s
P01.23	Start delay	0.0–60.0s	0.0s
P01.24	Stop speed delay	0.0–100.0s	0.0s
P01.25	Open-loop 0Hz output selection	0: No voltage output 1: With voltage output 2: Output as per DC braking current of stop	0
P01.26	Deceleration time of emergency-stop	0.0–60.0s	2.0s
P01.27	Time of starting section of deceleration S curve	0.0–50.0s	0.1s
P01.28	Time of ending section of deceleration S curve	0.0–50.0s	0.1s
P01.29	Short-circuit braking current	0.0–150.0% (of rated VFD output current)	0.0%
P01.30	Hold time of short-circuit braking at startup	0.00–50.00s	0.00s
P01.31	Hold time of short-circuit braking at stop	0.00–50.00s	0.00s

Function code	Name	Detailed parameter description	Default value
P01.32	Pre-exciting time of jogging	0.000–10.000s	0.300s
P01.33	Starting frequency of braking for jogging to stop	0.00Hz–P00.03	0.00Hz
P01.34	Delay to enter sleep	0.0–3600.0s	0.0s
P05.01–P05.06	Digital input function selection	1: Forward running 2: Reverse running 4: Forward jogging 5: Reverse jogging 6: Coast to stop 7: Fault reset 8: Running pause 21: Acceleration/deceleration time selection 1 22: Acceleration/deceleration time selection 2 30: Acceleration/deceleration disabled	/
P08.06	Running frequency of jog	0.00Hz–P00.03 (Max. output frequency)	5.00Hz
P08.07	Acceleration time at jogging	0.0–3600.0s	Depends on model
P08.08	Deceleration time at jogging	0.0–3600.0s	Depends on model
P08.00	Acceleration time 2	0.0–3600.0s	Depends on model
P08.01	Declaration time 2	0.0–3600.0s	Depends on model
P08.02	Acceleration time 3	0.0–3600.0s	Depends on model
P08.03	Declaration time 3	0.0–3600.0s	Depends on model
P08.04	Acceleration time 4	0.0–3600.0s	Depends on model
P08.05	Declaration time 4	0.0–3600.0s	Depends on model
P08.19	Switching frequency of acceleration/deceleration time	0.00–P00.03 (Max. output frequency) 0.00Hz: No switch over If the running frequency is larger than P08.19, switch to acceleration /deceleration time 2	0

Function code	Name	Detailed parameter description	Default value
P08.21	Reference frequency of acceleration/deceleration time	0: Max. output frequency 1: Set frequency 2: 100Hz <b>Note:</b> Valid for straight-line acceleration/deceleration only	0
P08.28	Automatic fault reset times	0–10	0
P08.29	Automatic fault reset time interval	0.1–3600.0s	1.0s

### 5.5.8 Frequency setting

The UMI-B7 series VFD supports multiple kinds of frequency reference modes, which can be categorized into two types: main reference channel and auxiliary reference channel.

There are two main reference channels, namely frequency reference channel A and frequency reference channel B. These two channels support simple arithmetical operation between each other, and they can be switched dynamically by setting multifunction terminals.

There is one input mode for auxiliary reference channel, namely terminal UP/DOWN switch input. By setting function codes, you can enable the corresponding reference mode and the impact made on the VFD frequency reference by this reference mode.

The actual reference for VFD is comprised of the main reference channel and auxiliary reference channel.

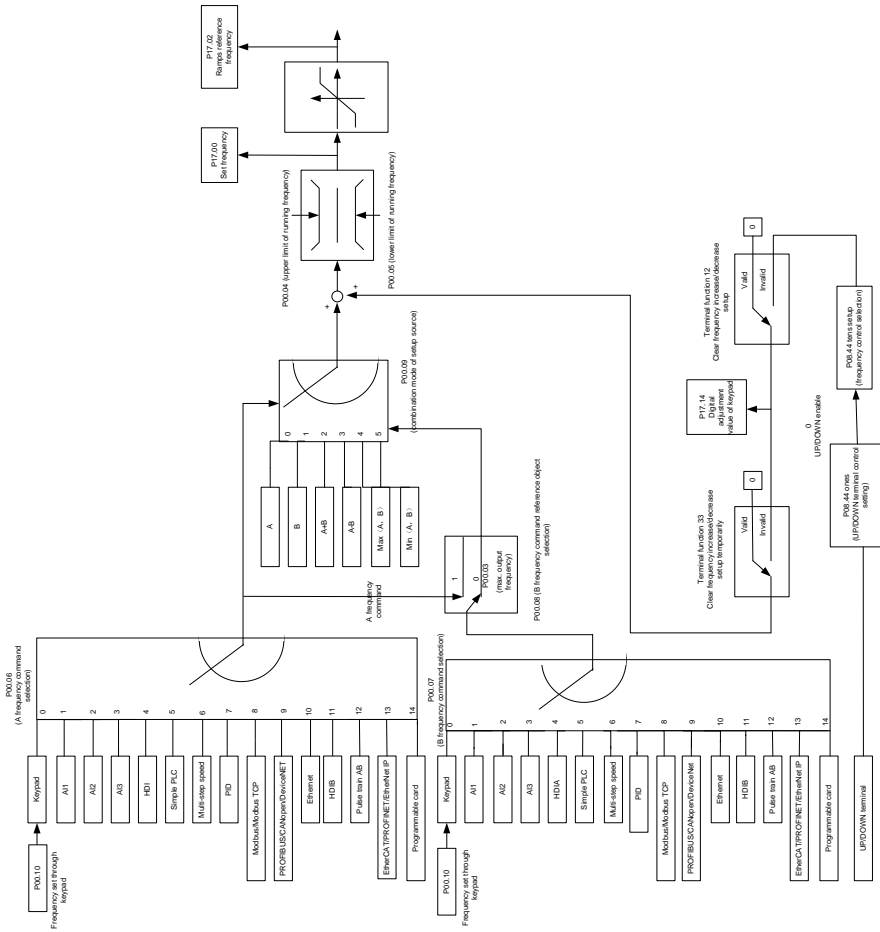

UMI-B7 VFD supports switchover between different reference channels, and the rules for channel switchover are shown below.

Present reference channel P00.09	Multifunction terminal function 13 Channel A switched to channel B	Multifunction terminal function 14 Combination setting switched to channel A	Multifunction terminal function 15 Combination setting switched to channel B
A	B	/	/
B	A	/	/
A+B	/	A	B
A-B	/	A	B
Max (A, B)	/	A	B



Present reference channel P00.09	Multifunction terminal function 13 Channel A switched to channel B	Multifunction terminal function 14 Combination setting switched to channel A	Multifunction terminal function 15 Combination setting switched to channel B
Min (A, B)	/	A	B

**Note:** "/" indicates this multifunction terminal is invalid under present reference channel.

When setting the auxiliary frequency inside the VFD via multifunction terminal UP (10) and DOWN (11), you can increase/decrease the frequency quickly by setting P08.45 (UP terminal frequency incremental change rate) and P08.46 (DOWN terminal frequency decrement change rate).

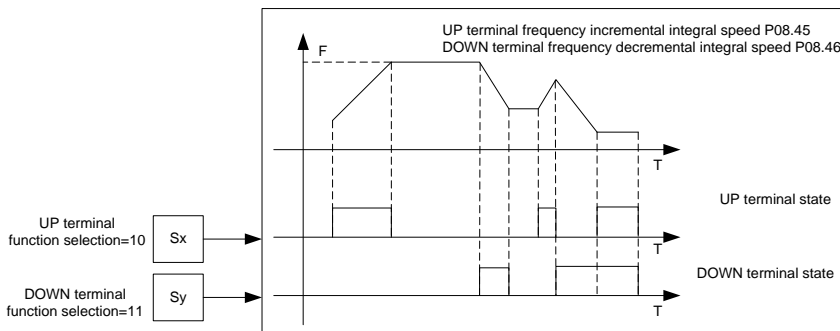

Related parameter list:

Function code	Name	Detailed parameter description	Default value
P00.03	Max. output frequency	Max.(P00.04, 10.00) – 630.00Hz	60.00Hz
P00.04	Upper limit of running frequency	P00.05–P00.03	60.00Hz
P00.05	Lower limit of running frequency	0.00Hz–P00.04	0.00Hz
P00.06	A frequency command selection	0: Set via keypad 1: Set via AI1 2: Set via AI2 3: Set via AI3	0
P00.07	B frequency command selection	4: Set via high-speed pulse HDIA 5: Set via simple PLC program 6: Set via multi-step speed running 7: Set via PID control 8: Set via Modbus/Modbus TCP communication 9: Set via CANopen communication	15

Function code	Name	Detailed parameter description	Default value
		10: Set via Ethernet communication 11: Set via high-speed pulse HDIB 12: Set via Pulse train AB 13: Set via EtherCAT/PROFINET/EtherNet IP communication 14: Set via programmable card 15: Reserved	
P00.08	Reference object of B frequency command	0: Max. output frequency 1: A frequency command	0
P00.09	Combination mode of setting source	0: A 1: B 2: (A+B) 3: (A-B) 4: Max (A, B) 5: Min (A, B)	0
P05.01–P05.06	Function of multifunction digital input terminal (S1–S4, HDIA, HDIB)	10: Frequency increase (UP) 11: Frequency decrease (DOWN) 12: Clear frequency increase/decrease setting 13: Switchover between setting A and setting B 14: Switchover between combination setting and setting A 15: Switchover between combination setting and setting B	/
P08.42	Reserved	/	/
P08.43	Reserved	/	/
P08.44	<b>UP/DOWN</b> terminal control	0x000–0x221 Ones: Frequency enabling selection 0: Setting through the <b>UP/DOWN</b> terminal is valid 1: Setting through the <b>UP/DOWN</b> terminal is invalid Tens: Frequency control selection 0: Valid only when P00.06=0 or P00.07=0 1: Valid for all frequency modes	0x000

Function code	Name	Detailed parameter description	Default value
		2: Invalid for multi-step speed when multi-step speed takes priority Hundreds: Action selection at stop 0: Valid 1: Valid during running, clear after stop 2: Valid during running, clear after receiving stop command	
P08.45	UP terminal frequency incremental change rate	0.01–50.00 Hz/s	0.50 Hz/s
P08.46	DOWN terminal frequency decrement change rate	0.01–50.00 Hz/s	0.50 Hz/s
P17.00	Set frequency	0.00Hz–P00.03 (Max. output frequency)	0.00Hz
P17.02	Ramps reference frequency	0.00Hz–P00.03 (Max. output frequency)	0.00Hz
P17.14	Digital adjustment value	0.00Hz–P00.03	0.00Hz

**5.5.9 Analog input**

The UMI-B7 series VFD carries two analog input terminals (AI1 is 0–10V/0–20mA (voltage input or current input can be set by P05.50); AI2 is -10–10V) and two high-speed pulse input terminals. Each input can be filtered separately, and the corresponding reference curve can be set by adjusting the reference corresponds to the max. value and min. value.

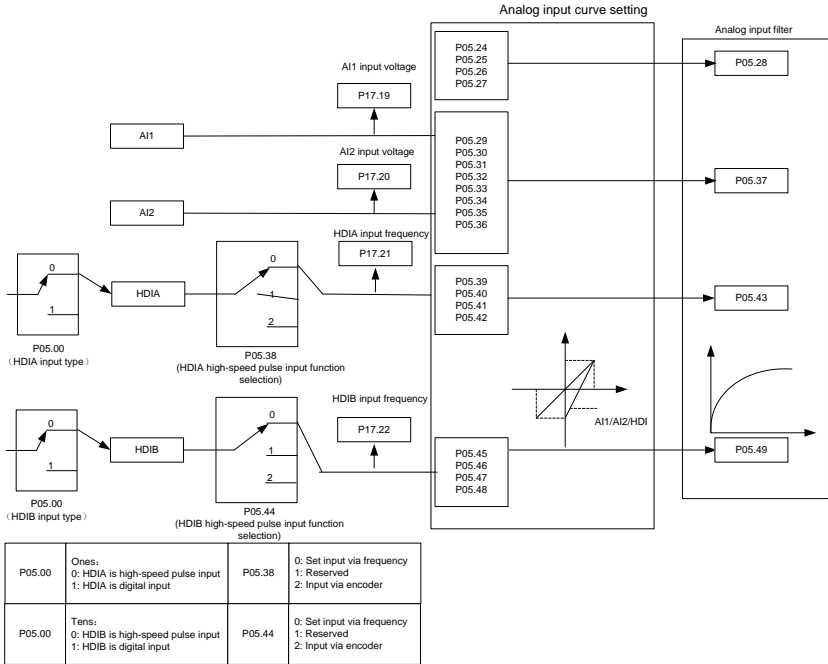

Related parameter list:

Function code	Name	Detailed parameter description	Default value
P05.00	HDI input type	0x00–0x11 Ones: HDIA input type 0: HDIA is high-speed pulse input 1: HDIA is digital input Tens: HDIB input type 0: HDIB is high-speed pulse input 1: HDIB is digital input	0x00
P05.24	Lower limit value of AI1	0.00V–P05.26	0.00V
P05.25	Corresponding setting of lower limit of AI1	-300.0%–300.0%	0.0%
P05.26	Upper limit value of AI1	P05.24–10.00V	10.00V
P05.27	Corresponding setting of upper limit of AI1	-300.0%–300.0%	100.0%
P05.28	Input filter time of AI1	0.000s–10.000s	0.100s
P05.29	Lower limit value of AI2	-10.00V–P05.31	-10.00V

Function code	Name	Detailed parameter description	Default value
P05.30	Corresponding setting of lower limit of AI2	-300.0%–300.0%	-100.0%
P05.31	Intermediate value 1 of AI2	P05.29–P05.33	0.00V
P05.32	Corresponding setting of intermediate value 1 of AI2	-300.0%–300.0%	0.0%
P05.33	Intermediate value 2 of AI2	P05.31–P05.35	0.00V
P05.34	Corresponding setting of intermediate value 2 of AI2	-300.0%–300.0%	0.0%
P05.35	Upper limit value of AI2	P05.33–10.00V	10.00V
P05.36	Corresponding setting of upper limit of AI2	-300.0%–300.0%	100.0%
P05.37	Input filter time of AI2	0.000s–10.000s	0.100s
P05.38	HDIA high-speed pulse input function	0: Set input via frequency 1: Reserved 2: Input via encoder, used in combination with HDIB	0
P05.39	Lower limit frequency of HDIA	0.000 kHz – P05.41	0.000kHz
P05.40	Corresponding setting of lower limit frequency of HDIA	-300.0%–300.0%	0.0%
P05.41	Upper limit frequency of HDIA	P05.39–50.000kHz	50.000kHz
P05.42	Corresponding setting of upper limit frequency of HDIA	-300.0%–300.0%	100.0%
P05.43	HDIA frequency input filter time	0.000s–10.000s	0.030s
P05.44	HDIB high-speed pulse input function selection	0: Set input via frequency 1: Reserved 2: Input via encoder, used in combination with HDIA	0
P05.45	Lower limit frequency of HDIB	0.000 kHz – P05.47	0.000kHz
P05.46	Corresponding setting of lower limit frequency of HDIB	-300.0%–300.0%	0.0%

Function code	Name	Detailed parameter description	Default value
P05.47	Upper limit frequency of HDIB	P05.45–50.000kHz	50.000kHz
P05.48	Corresponding setting of upper limit frequency of HDIB	-300.0%–300.0%	100.0%
P05.49	HDIB frequency input filter time	0.000s–10.000s	0.030s
P05.50	AI1 input signal type	0–1 0: Voltage type 1: Current type	0

**5.5.10 Analog output**

The UMI-B7 series VFD carries one analog output terminal (0–10V/0–20mA) and one high-speed pulse output terminal. Analog output signals can be filtered separately, and the proportional relation can be adjusted by setting the max. value, min. value, and the percentage of their corresponding output. Analog output signal can output motor speed, output frequency, output current, motor torque and motor power at a certain proportion.

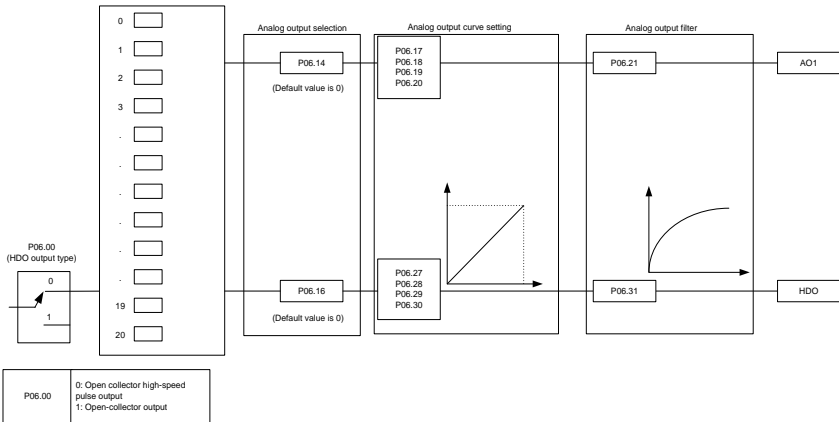

AO output relationship description:

(The min. value and max. value of the output correspond to 0.0% and 100.00% of the pulse or analog default output. The actual output voltage or pulse frequency corresponds to the actual percentage, which can be through function codes.)

Set value	Function	Description
0	Running frequency	0–Max. output frequency
1	Set frequency	0–Max. output frequency

Set value	Function	Description
2	Ramp reference frequency	0–Max. output frequency
3	Running speed	0–Synchronous speed corresponding to max. output frequency
4	Output current (relative to VFD)	0–Twice the VFD rated current
5	Output current (relative to motor)	0–Twice the motor rated current
6	Output voltage	0–1.5 times the VFD rated voltage
7	Output power	0–Twice the motor rated power
8	Set torque value	0–Twice the motor rated current. A negative value corresponds to 0.0% by default.
9	Output torque	0 – +/- (Twice the motor rated torque)
10	A11 input value	0–10V/0–20mA
11	A12 input value	0V–10V. A negative value corresponds to 0.0% by default.
12	A13 input value	0–10V/0–20mA
13	Input value of high-speed pulse HDIA	0.00–50.00kHz
14	Set value 1 of Modbus communication	0–1000
15	Set value 2 of Modbus communication	0–1000
16	Set value 1 of CANopen communication	0–1000
17	Set value 2 of CANopen communication	0–1000
18	Set value 1 of Ethernet communication	0–1000
19	Set value 2 of Ethernet communication	0–1000
20	Input value of high-speed pulse HDIB	0.00–50.00kHz
21	Set value 1 of EtherCAT/PROFINET/EtherNet IP communication	0–1000. A negative value corresponds to 0.0% by default.
22	Torque current (bipolar)	0–Triple the motor rated current. A negative value corresponds to 0.0% by default.
23	Exciting current	0–Triple the motor rated current. A negative value

Set value	Function	Description
		corresponds to 0.0% by default.
24	Set frequency (bipolar)	0–Max. output frequency. A negative value corresponds to 0.0% by default.
25	Ramp reference frequency (bipolar)	0–Max. output frequency. A negative value corresponds to 0.0% by default.
26	Running speed (bipolar)	0–Synchronous speed corresponding to max. output frequency. A negative value corresponds to 0.0% by default.
27	Set value 2 of EtherCAT/PROFINET/EtherNet IP communication	0–1000
28	C_AO1 from PLC	0–1000
29	C_AO2 from PLC	0–1000
30	Running speed	0–Twice the motor rated synchronous speed.
31	Output torque (bipolar)	0–Twice the motor rated torque. A negative value corresponds to 0.0% by default.
32	AI/AO temperature detection output	AO value of AI/AO temperature detection

Related parameter list:

Function code	Name	Detailed parameter description	Default value
P06.00	HDO output type	0: Open collector high-speed pulse output 1: Open collector output	0
P06.14	AO1 output selection	0: Running frequency (0–Max. output frequency) 1: Set frequency (0–Max. output frequency) 2: Ramp reference frequency (0–Max. output frequency) 3: Rotational speed (100% corresponds to the speed at max. output frequency.) 4: Output current (100% corresponds to twice the VFD rated current.) 5: Output current (100% corresponds to twice the motor rated current.) 6: Output voltage (100% corresponds to	0
P06.15	Reserved		0
P06.16	HDO high-speed pulse output		0



Function code	Name	Detailed parameter description	Default value
		1.5 times the VFD rated voltage.) 7: Output power (100% corresponds to twice the motor rated power.) 8: Set torque (100% corresponds to twice the motor rated current.) 9: Output torque (Absolute value; 100% corresponds to twice the motor rated torque.) 10: AI1 input (0–10V/0–20mA) 11: AI2 input (0–10V) 12: AI3 input (0–10V/0–20mA) 13: HDIA input (0.00–50.00kHz) 14: Value 1 set through Modbus communication (0–1000) 15: Value 2 set through Modbus communication (0–1000) 16: Value 1 set through CANopen (0–1000) 17: Value 2 set through CANopen (0–1000) 18: Value 1 set through Ethernet 1 (0–1000) 19: Value 2 set through Ethernet 2 (0–1000) 20: HDIB input (0.00–50.00kHz) 21: Value 1 set through EtherCAT/PROFINET/EtherNet IP (0–1000) 22: Torque current (bipolar; 100% corresponds to triple the motor rated current.) 23: Exciting current (bipolar; 100% corresponds to triple the motor rated current.) 24: Set frequency (bipolar; 0–Max. output frequency) 25: Ramp reference frequency (bipolar; 0–Max. output frequency) 26: Rotational speed (bipolar; 0–Speed	

Function code	Name	Detailed parameter description	Default value
		corresponding to max. output frequency) 27: Value 2 set through EtherCAT/PROFINET/EtherNet IP communication (0–1000) 28: AO1 from the programmable card (0–1000) 29: AO2 from the programmable card (0–1000) 30: Rotational speed (100% corresponds to twice the motor rated synchronous speed) 31: Output torque (Actual value, 100% corresponds to twice the motor rated torque) 32: AI/AO temperature detection output 33–63: Reserved <b>Note:</b> When AO1 is of the current output type, 100% corresponds to 20mA; when AO1 is of the voltage output type, 100% corresponds to 10V; 100% of HDO corresponds to the output of P06.30.	
P06.17	Lower limit of AO1 output	-300.0%–P06.19	0.0%
P06.18	Corresponding AO1 output of lower limit	0.00V–10.00V	0.00V
P06.19	Upper limit of AO1 output	P06.17–300.0%	100.0%
P06.20	Corresponding AO1 output of upper limit	0.00V–10.00V	10.00V
P06.21	AO1 output filter time	0.000s–10.000s	0.000s
P06.22	Reserved		
P06.23	PTC constant output current setting	0.000–20.000mA	4.000mA
P06.24	PTC resistance alarm threshold	0–60000Ω	750Ω
P06.25	PTC resistance alarm recovery threshold	0–60000Ω	150Ω
P06.26	Actual PTC resistance	0–60000Ω	0Ω

Function code	Name	Detailed parameter description	Default value
P06.27	Lower limit of HDO output	-300.0%–P06.29	0.0%
P06.28	Corresponding HDO output of lower limit	0.00–50.00kHz	0.0kHz
P06.29	Upper limit of HDO output	P06.27–300.0%	100.0%
P06.30	Corresponding HDO output of upper limit	0.00–50.00kHz	50.00kHz
P06.31	HDO output filter time	0.000s–10.000s	0.000s

**5.5.11 Digital input**

The UMI-B7 series VFD carries four programmable digital input terminals and two HDI input terminals. The function of all the digital input terminals can be programmed by function codes. HDI input terminal can be set to act as high-speed pulse input terminal or common digital input terminal; if it is set to act as high-speed pulse input terminal, you can also set HDIA or HDIB high-speed pulse input to serve as the frequency reference and encoder signal input.

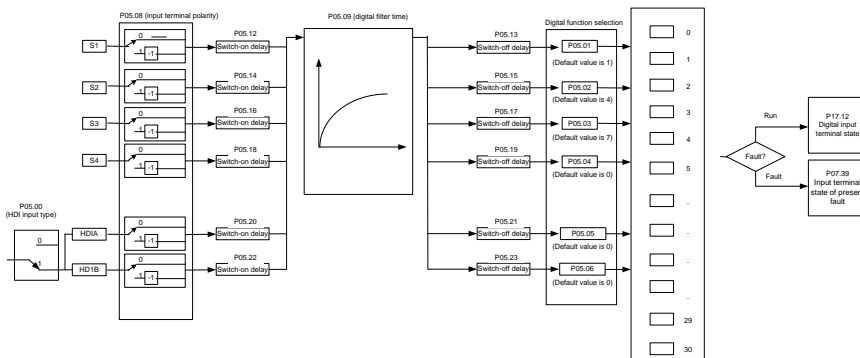

This parameter is used to set the corresponding function of digital multifunction input terminals.

**Note:** Two different multifunction input terminals cannot be set to the same function.

Setting	Function	Description
0	No function	The VFD does not act even if there is signal input; you can set the unused terminals to "no function" to avoid misacts.
1	Forward running (FWD)	Control the forward/reverse running of the VFD by external terminals.
2	Reverse running (REV)	
3	3-wire control/S <sub>in</sub>	Set the VFD running mode to 3-wire control mode by this terminal. See P05.13 for details.
4	Forward jogging	Frequency when jogging, see P08.06, P08.07 and

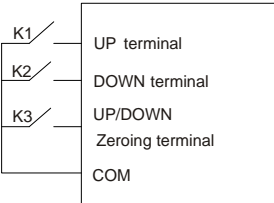
Setting	Function	Description
5	Reverse jogging	P08.08 for jogging acceleration/deceleration time.
6	Coast to stop	The VFD blocks output, and the stop process of motor is uncontrolled by the VFD. This mode is applied in cases of large-inertia load and free stop time; its definition is the same with P01.08, and it is mainly used in remote control.
7	Fault reset	External fault reset function, its function is the same with the <b>STOP/RST</b> key on the keypad. This function can be used in remote fault reset.
8	Running pause	The VFD decelerates to stop, however, all the running parameters are in memory state, such as PLC parameter, wobbling frequency, and PID parameter. After this signal disappears, the VFD will revert to the state before stop.
9	External fault input	When external fault signal is transmitted to the VFD, the VFD releases fault alarm and stops.
10	Frequency increase (UP)	Used to change the frequency-increase/decrease command when the frequency is given by external terminals.
11	Frequency decrease (DOWN)	
12	Clear frequency increase/decrease setting	 <p>The terminal used to clear frequency-increase/decrease setting can clear the frequency value of auxiliary channel set by <b>UP/DOWN</b>, thus restoring the reference frequency to the frequency given by main reference frequency command channel.</p>
13	Switching between A setting and B setting	This function is used to switch between the frequency setting channels.
14	Switching between combination setting and A setting	A frequency reference channel and B frequency reference channel can be switched by no. 13 function; the combination channel set by P00.09 and the A frequency reference channel can be switched by no. 14 function; the combination channel set by P00.09 and the B frequency reference channel can be switched by no. 15 function.
15	Switching between combination setting and B setting	

Setting	Function	Description																				
16	Multi-step speed terminal 1	16-step speeds can be set by combining digital states of these four terminals. <b>Note:</b> Multi-step speed 1 is low bit, multi-step speed 4 is high bit.																				
17	Multi-step speed terminal 2																					
18	Multi-step speed terminal 3																					
19	Multi-step speed terminal 4		<table border="1"> <tr> <td>Multi-step speed 4</td> <td>Multi-step speed 3</td> <td>Multi-step speed 2</td> <td>Multi-step speed 1</td> </tr> <tr> <td><b>BIT3</b></td> <td><b>BIT2</b></td> <td><b>BIT1</b></td> <td><b>BIT0</b></td> </tr> </table>	Multi-step speed 4	Multi-step speed 3	Multi-step speed 2	Multi-step speed 1	<b>BIT3</b>	<b>BIT2</b>	<b>BIT1</b>	<b>BIT0</b>											
Multi-step speed 4	Multi-step speed 3	Multi-step speed 2	Multi-step speed 1																			
<b>BIT3</b>	<b>BIT2</b>	<b>BIT1</b>	<b>BIT0</b>																			
20	Multi-step speed pause	Pause multi-step speed selection function to keep the set value in present state.																				
21	Acceleration/deceleration time selection 1	Use these two terminals to select four groups of acceleration/decoration time.																				
22	Acceleration/deceleration time selection 2	<table border="1"> <thead> <tr> <th>Terminal 1</th> <th>Terminal 2</th> <th>Acceleration or deceleration time selection</th> <th>Corresponding parameter</th> </tr> </thead> <tbody> <tr> <td>OFF</td> <td>OFF</td> <td>Acceleration/ deceleration time 1</td> <td>P00.11/P00.12</td> </tr> <tr> <td>ON</td> <td>OFF</td> <td>Acceleration/ deceleration time 2</td> <td>P08.00/P08.01</td> </tr> <tr> <td>OFF</td> <td>ON</td> <td>Acceleration/ deceleration time 3</td> <td>P08.02/P08.03</td> </tr> <tr> <td>ON</td> <td>ON</td> <td>Acceleration/ deceleration time 4</td> <td>P08.04/P08.05</td> </tr> </tbody> </table>	Terminal 1	Terminal 2	Acceleration or deceleration time selection	Corresponding parameter	OFF	OFF	Acceleration/ deceleration time 1	P00.11/P00.12	ON	OFF	Acceleration/ deceleration time 2	P08.00/P08.01	OFF	ON	Acceleration/ deceleration time 3	P08.02/P08.03	ON	ON	Acceleration/ deceleration time 4	P08.04/P08.05
		Terminal 1	Terminal 2	Acceleration or deceleration time selection	Corresponding parameter																	
		OFF	OFF	Acceleration/ deceleration time 1	P00.11/P00.12																	
		ON	OFF	Acceleration/ deceleration time 2	P08.00/P08.01																	
		OFF	ON	Acceleration/ deceleration time 3	P08.02/P08.03																	
ON	ON	Acceleration/ deceleration time 4	P08.04/P08.05																			
23	Simple PLC stop reset	Restart simple PLC process and clear previous PLC state information.																				
24	Simple PLC pause	The program pauses during PLC execution and keeps running in current speed step. After this function is cancelled, simple PLC keeps running.																				
25	PID control pause	PID is ineffective temporarily, and the VFD maintains current frequency output.																				
26	Wobbling frequency pause (stop at current frequency)	The VFD pauses at current output. After this function is canceled, it continues wobbling-frequency operation at current frequency.																				
27	Wobbling frequency reset (revert to center frequency)	The set frequency of VFD reverts to center frequency.																				
28	Counter reset	Zero out the counter state.																				
29	Switching between speed control and torque control	The VFD switches from torque control mode to speed control mode, or vice versa.																				
30	Acceleration/deceleration disabled	Ensure the VFD will not be impacted by external signals (except for stop command) and maintains current output																				

Setting	Function	Description
		frequency.
31	Counter trigger	Enable pulse counting of the counter.
33	Clear frequency increase/decrease setting temporarily	When the terminal is closed, the frequency value set by <b>UP/DOWN</b> can be cleared to restore the reference frequency to the frequency given by frequency command channel; when terminal is disconnected, it will revert to the frequency value after frequency increase/decrease setting.
34	DC braking	The VFD starts DC braking immediately after the command becomes valid.
35	Switching between motor 1 and motor 2	When this terminal is valid, you can realize switchover control of two motors.
36	Command switches to keypad	When this terminal is valid, the running command channel will switch to keypad compulsorily. If this function becomes invalid, the running command channel will revert to the original state.
37	Command switches to terminal	When this terminal is valid, the running command channel will switch to terminal compulsorily. If this function becomes invalid, the running command channel will revert to the original state.
38	Command switches to communication	When this terminal is valid, the running command channel will switch to communication compulsorily. If this function becomes invalid, the running command channel will revert to the original state.
39	Pre-exciting command	When this terminal is valid, motor pre-exciting will be started until this terminal becomes invalid.
40	Zero out power consumption quantity	After this command becomes valid, the power consumption quantity of the VFD will be zeroed out.
41	Maintain power consumption quantity	When this command is valid, current operation of the VFD will not impact the power consumption quantity.
42	Source of upper torque limit switches to keypad	When this command is valid, the upper limit of the torque will be set by keypad
43	Position reference point input	Valid only for S2, S3, and S4.
44	Disable spindle orientation	Spindle orientation is invalid.
45	Spindle zeroing/local position zeroing	Spindle positioning is triggered.
46	Spindle zero position selection 1	Spindle zero position selection 1.

Setting	Function	Description
47	Spindle zero position selection 2	Spindle zero position selection 2.
48	Spindle scale division selection 1	Spindle scale division selection 1.
49	Spindle scale division selection 2	Spindle scale division selection 2.
50	Spindle scale division selection 3	Spindle scale division selection 3.
51	Position/speed control switchover terminal	Terminal for switching between position control and speed control.
52	Disable pulse input	Pulse input is invalid when the terminal is valid.
53	Clear position deviation	Used to clear the input deviation of position loop.
54	Switch position proportional gains	Used to switch position proportional gains.
55	Enable cyclic digital positioning	Cyclic positioning can be enabled when digital positioning is valid.
56	Emergency stop	When this command is valid, the motor decelerate to emergency stop as per the time set by P01.26.
57	Motor over-temperature fault input	Motor stops at motor over-temperature fault input.
59	FVC switches to SVPWM control	When this terminal is valid in stop state, switch to SVPWM control.
60	Switch to FVC control	When this terminal is valid in stop state, switch to FVC (closed-loop vector) control.
61	PID polarity switchover	Switching the output polarity of PID, this terminal should be used in conjunction with P09.03
62	Reserved	
63	Enable servo	When the thousands place of P21.00 is set to enable the servo, the servo enabling terminal is valid, which controls the VFD to enter zero servo control. At this situation, no startup command is needed.
64	FWD max. limit	Max frequency limit on forward rotation
65	REV max limit	Max frequency limit on reverse rotation
66	Zero out the counter	Zero out the position counting value
67	Pulse increase	When the terminal function is valid, the pulse input is increased according to the P21.27 pulse speed.
68	Enable pulse	When the pulse superimposition is enabled, pulse

Setting	Function	Description
	superimposition	increase and pulse decrease are effective.
69	Pulse decrease	When the terminal function is valid, the pulse input is decreased according to the P21.27 pulse speed.
70	Electronic gear selection	When the terminal is valid, the proportional numerator is switched to the P21.30 numerator of the 2 <sup>nd</sup> command ratio.
71	Switch to mater	In stopped state, if the function is valid, the master is used.
72	Switch to slave	In stopped state, if the function is valid, the slave is used.
73	Reset roll diameter	Used to reset the roll diameter when the tension control function is enabled.
74	Switch winding/unwinding	Used to switch winding/unwinding modes when the tension control function is enabled.
75	Tension control pre-drive	If the terminal is valid when the tension control function is enabled, tension control pre-drive is performed.
76	Disable roll diameter calculation	If the terminal is valid when the tension control function is enabled, roll diameter calculation is disabled.
77	Clear alarm display	Used to clear the alarm display when the tension control function is enabled.
78	Manual braking of tension control	If the terminal is valid when the tension control function is enabled, manual braking is activated.
79	Trigger forced feeding interrupt	If the terminal is valid when the tension control function is enabled, a feeding interrupt signal is triggered forcibly.
80	Initial roll diameter 1	Used to select different initial roll diameters by combining with the initial roll diameter 2 when the tension control function is enabled.
81	Initial roll diameter 2	Used to select different initial roll diameters by combining with the initial roll diameter 1 when the tension control function is enabled.
82	Trigger fire mode control	In fire mode, if the terminal is valid, the fire mode control signal is triggered.
83	Switch tension PID parameters	Used to switch two PID parameter groups when the tension control function is enabled. The first group is used by default. If the terminal is valid, the second group is used.
84–95	Reserved	

Related parameter list:



Function code	Name	Detailed parameter description	Default value
P05.00	HDI input type	0x00–0x11 Ones: HDIA input type 0: HDIA is high-speed pulse input 1: HDIA is digital input Tens: HDIB input type 0: HDIB is high-speed pulse input 1: HDIB is digital input	0x00
P05.01	Function of S1 terminal	0: No function	1
P05.02	Function of S2 terminal	1: Forward running	4
P05.03	Function of S3 terminal	2: Reverse running	7
P05.04	Function of S4 terminal	3: 3-wire control/S <sub>in</sub>	0
P05.05	Function of HDIA terminal	4: Forward jogging	0
P05.06	Function of HDIB terminal	5: Reverse jogging 6: Coast to stop 7: Fault reset 8: Running pause 9: External fault input 10: Frequency increase (UP) 11: Frequency decrease (DOWN) 12: Clear frequency increase/decrease setting 13: Switchover between setting A and setting B 14: Switchover between combination setting and A setting 15: Switchover between combination setting and setting B 16: Multi-step speed terminal 1 17: Multi-step speed terminal 2 18: Multi-step speed terminal 3 19: Multi-step speed terminal 4 20: Multi-step speed pause 21: Acceleration/deceleration time selection 1 22: Acceleration/deceleration time selection 2 23: Simple PLC stop reset 24: Simple PLC pause 25: PID control pause	0

Function code	Name	Detailed parameter description	Default value
		26: Wobbling frequency pause 27: Wobbling frequency reset 28: Counter reset 29: Switching between speed control and torque control 30: Acceleration/deceleration disabled 31: Counter trigger 32: Reserved 33: Clear frequency increase/decrease setting temporarily 34: DC braking 35: Switch from motor 1 to motor 2 36: Command switches to keypad 37: Command switches to terminal 38: Command switches to communication 39: Pre-exciting command 40: Zero out power consumption quantity 41: Maintain power consumption quantity 42: Switching the upper torque limit setting mode to keypad 43: Position reference point input (valid only for S2, S3, and S4) 44: Spindle orientation disabled 45: Spindle zeroing/local position zeroing 46: Spindle zero-position setting 1 47: Spindle zero-position setting 2 48: Spindle indexing setting 1 49: Spindle indexing setting 2 50: Spindle indexing setting 3 51: Terminal for switching between position control and speed control 52: Disable pulse input 53: Eliminate position deviation	

Function code	Name	Detailed parameter description	Default value
		54: Switch position proportional gain 55: Enable cyclic digital positioning 56: Emergency stop 57: Motor overtemperature fault input 59: Switch to V/F control 60: Switch to FVC control 61: PID polarity switchover 62: Reserved 63: Enable servo 64: FWD max. limit 65: REV max limit 66: Zero out encoder counting 67: Pulse increase 68: Enable pulse superimposition 69: Pulse decrease 70: Electronic gear selection 71: Switch to the master 72: Switch to the slave 73: Reset the roll diameter 74: Switch winding/unwinding 75: Pre-drive 76: Disable roll diameter calculation 77: Clear alarm display 78: Manual braking 79: Trigger forced feeding interrupt 80: Initial roll diameter 1 81: Initial roll diameter 2 82: Trigger fire mode control 83: Switch tension PID parameters 84–95: Reserved	
P05.07	Reserved		
P05.08	Polarity of input terminal	0x00–0x3F	0x00
P05.09	Digital filter time	0.000–1.000s	0.010s
P05.10	Virtual terminal setting	0x00–0x3F (0: disable, 1: enable) BIT0: S1 virtual terminal BIT1: S2 virtual terminal BIT2: S3 virtual terminal BIT3: S4 virtual terminal	0x00

Function code	Name	Detailed parameter description	Default value
		BIT4: HDIA virtual terminal BIT5: HDIB virtual terminal	
P05.11	2/3-wire control mode	0: 2-wire control 1 1: 2-wire control 2 2: 3-wire control 1 3: 3-wire control 2	0
P05.12	S1 terminal switch-on delay	0.000–50.000s	0.000s
P05.13	S1 terminal switch-off delay	0.000–50.000s	0.000s
P05.14	S2 terminal switch-on delay	0.000–50.000s	0.000s
P05.15	S2 terminal switch-off delay	0.000–50.000s	0.000s
P05.16	S3 terminal switch-on delay	0.000–50.000s	0.000s
P05.17	S3 terminal switch-off delay	0.000–50.000s	0.000s
P05.18	S4 terminal switch-on delay	0.000–50.000s	0.000s
P05.19	S4 terminal switch-off delay	0.000–50.000s	0.000s
P05.20	HDIA terminal switch-on delay	0.000–50.000s	0.000s
P05.21	HDIA terminal switch-off delay	0.000–50.000s	0.000s
P05.22	HDIB terminal switch-on delay	0.000–50.000s	0.000s
P05.23	HDIB terminal switch-off delay	0.000–50.000s	0.000s
P07.39	Input terminal state at present fault	/	0x0000
P17.12	Digital input terminal state	/	0x00

**5.5.12 Digital output**

The UMI-B7 series VFD carries two groups of relay output terminals, one open collector Y output terminal and one high-speed pulse output (HDO) terminal. The function of all the digital output terminals can be programmed by function codes, of which the high-speed pulse output terminal HDO can also be set to high-speed pulse output or digital output by function code.

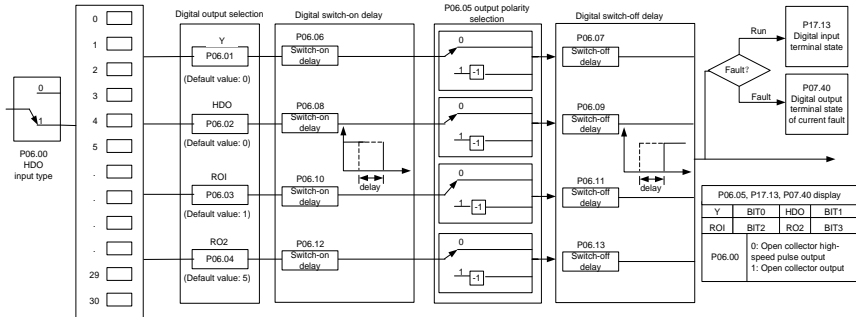

The table below lists the options for the above four function parameters, and you are allowed to select the same output terminal functions repetitively.

Setting	Function	Description
0	Invalid	The output terminal has no function.
1	In running	Output ON signal when there is frequency output during running.
2	In forward running	Output ON signal when there is frequency output during forward running.
3	In reverse running	Output ON signal when there is frequency output during reverse running.
4	In jogging	Output ON signal when there is frequency output during jogging.
5	VFD fault	Output ON signal when VFD fault occurred.
6	Frequency level detection FDT1	Refer to P08.32 and P08.33.
7	Frequency level detection FDT2	Refer to P08.34 and P08.35.
8	Frequency reached	Refer to P08.36.
9	Running in zero speed	Output ON signal when the VFD output frequency and reference frequency are both zero.
10	Reach upper limit frequency	Output ON signal when the running frequency reaches upper limit frequency
11	Reach lower limit frequency	Output ON signal when the running frequency reached lower limit frequency
12	Ready to run	Main circuit and control circuit powers are established, the protection functions do not act; when the VFD is ready to run, output ON signal.
13	In pre-exciting	Output ON signal during pre-exciting of the VFD
14	Overload pre-alarm	Output ON signal after the pre-alarm time elapsed based on the pre-alarm threshold; see P11.08–

Setting	Function	Description
		P11.10 for details.
15	Underload pre-alarm	Output ON signal after the pre-alarm time elapsed based on the pre-alarm threshold; see P11.11–P11.12 for details.
16	Simple PLC state completed	Output signal when current stage of simple PLC is completed
17	Simple PLC cycle completed	Output signal when a single cycle of simple PLC operation is completed
23	Virtual terminal output of Modbus/Modbus TCP communication	Output corresponding signal based on the set value of Modbus; output ON signal when it is set to 1, output OFF signal when it is set to 0
24	Virtual terminal output of CANopen communication	Output corresponding signal based on the set value of CANopen; output ON signal when it is set to 1, output OFF signal when it is set to 0
25	Virtual terminal output of Ethernet communication	Output corresponding signal based on the set value of Ethernet; output ON signal when it is set to 1, output OFF signal when it is set to 0.
26	DC bus voltage established	Output is valid when the bus voltage is above the undervoltage threshold of the inverter
27	Z pulse output	Output is valid when the encoder Z pulse is arrived, and is invalid after 10ms.
28	During pulse superposition	Output is valid when the pulse superposition terminal input function is valid
29	STO action	Output when STO fault occurred
30	Positioning completed	Output is valid when position control positioning is completed
31	Spindle zeroing completed	Output is valid when spindle zeroing is completed
32	Spindle scale-division completed	Output is valid when spindle scale-division is completed
33	In speed limit	Output is valid when the frequency is limited
34	Virtual terminal output of EtherCAT/PROFINET/EtherNet IP communication	The corresponding signal is output according to the set value of PROFINET communication. When it is set to 1, the ON signal is output, and when it is set to 0, the OFF signal is output.
35	Reserved	
36	Speed/position control switchover completed	Output is valid when the mode switchover is completed
37	Any frequency reached	The frequency reached signal is output when the present ramp reference frequency is greater than

Setting	Function	Description
		the detection value for frequency being reached.
38–40	Reserved	
41	Y1	Y1 from the programmable card
42	Y2	Y2 from the programmable card
43	HDO	HDO from the programmable card
44	RO1	RO1 from the programmable card
45	RO2	RO2 from the programmable card
46	RO3	RO3 from the programmable card
47	RO4	RO4 from the programmable card
48	EC PT100 detected OH pre-alarm	Pre-alarm of overheating (OH) detected by the expansion card (EC) with PT100.
49	EC PT1000 detected OH pre-alarm	Pre-alarm of OH detected by the EC with PT1000.
50	AI/AO detected OH pre-alarm	Pre-alarm of OH detected by AI/AO.
51	Stopped or running at zero speed	The VFD is in stopped state or running at zero speed.
52	Disconnection detected in tension control	Disconnection is detected when the disconnection detection is enabled in tension control.
53	Roll diameter setting reached	The set roll diameter is reached during running in tension control.
54	Max. roll diameter reached	The max. roll diameter is reached during running in tension control.
55	Min. roll diameter reached	The min. roll diameter is reached during running in tension control.
56	Fire control mode enabled	The fire mode is turned on.
57–63	Reserved	

Related parameter list:

Function code	Name	Detailed parameter description	Default value
P06.00	HDO output type	0: Open collector high-speed pulse output 1: Open collector output	0
P06.01	Y1 output selection	0: Invalid	0
P06.02	HDO output selection	1: In running	0
P06.03	Relay RO1 output selection	2: In forward running 3: In reverse running	1
P06.04	Relay RO2 output selection	4: In jogging 5: VFD fault 6: Frequency level detection FDT1	5

Function code	Name	Detailed parameter description	Default value
		7: Frequency level detection FDT2 8: Frequency reached 9: Running in zero speed 10: Reach upper limit frequency 11: Reach lower limit frequency 12: Ready to run 13: In pre-exciting 14: Overload pre-alarm 15: Underload pre-alarm 16: Simple PLC stage completed 17: Simple PLC cycle completed 18: Reach set counting value 19: Reach designated counting value 20: External fault is valid 21: Reserved 22: Reach running time 23: Virtual terminal output of Modbus/Modbus TCP communication 24: Virtual terminal output of CANopen communication 25: Virtual terminal output of Ethernet communication 26: DC bus voltage established 27: Z pulse output 28: During pulse superposition 29: STO action 30: Positioning completed 31: Spindle zeroing completed 32: Spindle scale-division completed 33: Speed limit reached in torque control 34: Virtual terminal output of EtherCAT/PROFINET/EtherNet IP communication 35: Reserved 36: Speed/position control switchover completed 37: Any frequency reached 38-40: Reserved 41: Y1 from the programmable card	



Function code	Name	Detailed parameter description	Default value
		42: Y2 from the programmable card 43: HDO from the programmable card 44: RO1 from the programmable card 45: RO2 from the programmable card 46: RO3 from the programmable card 47: RO4 from the programmable card 48: EC PT100 detected OH pre-alarm 49: EC PT1000 detected OH pre-alarm 50: AI/AO detected OH pre-alarm 51: Stopped or running at zero speed 52: Disconnection detected in tension control 53: Roll diameter setting reached 54: Max. roll diameter reached 55: Min. roll diameter reached 56: Fire control mode enabled 57–63: Reserved	
P06.05	Output terminal polarity selection	0x00–0x0F	0x00
P06.06	Y switch-on delay	0.000–50.000s	0.000s
P06.07	Y switch-off delay	0.000–50.000s	0.000s
P06.08	HDO switch-on delay	0.000–50.000s (valid only when P06.00=1)	0.000s
P06.09	HDO switch-off delay	0.000–50.000s (valid only when P06.00=1)	0.000s
P06.10	Relay RO1 switch-on delay	0.000–50.000s	0.000s
P06.11	Relay RO1 switch-off delay	0.000–50.000s	0.000s
P06.12	Relay RO2 switch-on delay	0.000–50.000s	0.000s
P06.13	Relay RO2 switch-off delay	0.000–50.000s	0.000s
P07.40	Output terminal state at present fault	/	0
P17.13	Digital output terminal state	/	0

**5.5.13 Simple PLC**

Simple PLC is a multi-step speed generator, and the VFD can change the running frequency and

direction automatically based on the running time to fulfill process requirements. Previously, such function was realized with external PLC, while now, the VFD itself can achieve this function.

The UMI-B7 series VFD can realize 16-step speeds control and provide four groups of acceleration/deceleration time for you to choose from.

After the set PLC completes one cycle (or one section), an ON signal can be output by the multifunction relay.

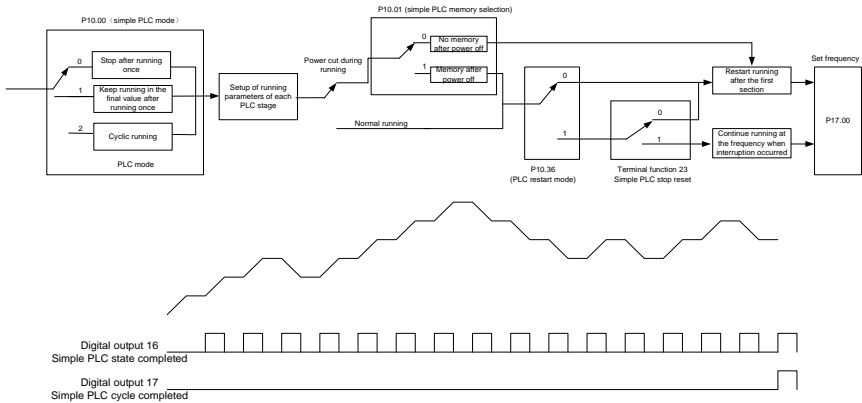

Related parameter list:

Function code	Name	Detailed parameter description	Default value
P05.01–P05.06	Digital input function	23: Simple PLC stop reset 24: Simple PLC pause 25: PID control pause	
P06.01–P06.04	Digital output function	16: Simple PLC stage reached 17: Simple PLC cycle reached	
P10.00	Simple PLC mode	0: Stop after running once 1: Keep running in the final value after running once 2: Cyclic running	0
P10.01	Simple PLC memory selection	0: No memory after power down 1: Memory after power down	0
P10.02	Multi-step speed 0	-300.0–300.0%	0.0%
P10.03	Running time of step 0	0.0–6553.5s (min)	0.0s
P10.04	Multi-step speed 1	-300.0–300.0%	0.0%
P10.05	Running time of step 1	0.0–6553.5s (min)	0.0s
P10.06	Multi-step speed 2	-300.0–300.0%	0.0%

Function code	Name	Detailed parameter description	Default value
P10.07	Running time of step 2	0.0–6553.5s (min)	0.0s
P10.08	Multi-step speed 3	-300.0–300.0%	0.0%
P10.09	Running time of step 3	0.0–6553.5s (min)	0.0s
P10.10	Multi-step speed 4	-300.0–300.0%	0.0%
P10.11	Running time of step 4	0.0–6553.5s (min)	0.0s
P10.12	Multi-step speed 5	-300.0–300.0%	0.0%
P10.13	Running time of step 5	0.0–6553.5s (min)	0.0s
P10.14	Multi-step speed 6	-300.0–300.0%	0.0%
P10.15	Running time of step 6	0.0–6553.5s (min)	0.0s
P10.16	Multi-step speed 7	-300.0–300.0%	0.0%
P10.17	Running time of step 7	0.0–6553.5s (min)	0.0s
P10.18	Multi-step speed 8	-300.0–300.0%	0.0%
P10.19	Running time of step 8	0.0–6553.5s (min)	0.0s
P10.20	Multi-step speed 9	-300.0–300.0%	0.0%
P10.21	Running time of step 9	0.0–6553.5s (min)	0.0s
P10.22	Multi-step speed 10	-300.0–300.0%	0.0%
P10.23	Running time of step 10	0.0–6553.5s (min)	0.0s
P10.24	Multi-step speed 11	-300.0–300.0%	0.0%
P10.25	Running time of step 11	0.0–6553.5s (min)	0.0s
P10.26	Multi-step speed 12	-300.0–300.0%	0.0%
P10.27	Running time of step 12	0.0–6553.5s (min)	0.0s
P10.28	Multi-step speed 13	-300.0–300.0%	0.0%
P10.29	Running time of step 13	0.0–6553.5s (min)	0.0s
P10.30	Multi-step speed 14	-300.0–300.0%	0.0%
P10.31	Running time of step 14	0.0–6553.5s (min)	0.0s
P10.32	Multi-step speed 15	-300.0–300.0%	0.0%
P10.33	Running time of step 15	0.0–6553.5s (min)	0.0s
P10.34	Acceleration/deceleration time of 0–7 stage of simple PLC	0x0000–0xFFFF	0000
P10.35	Acceleration/deceleration time of 8–15 stage of simple PLC	0x0000–0xFFFF	0000

Function code	Name	Detailed parameter description	Default value
P10.36	PLC restart mode	0: Restart from step 0 in multi-step speed running 1: Continue running at the frequency when interruption occurred	0
P17.00	Set frequency	0.00Hz–P00.03 (Max. output frequency)	0.00Hz
P17.27	Simple PLC and current stage number of multi-step speed	0–15	0

### 5.5.14 Multi-step speed running

Set the parameters used in multi-step speed running. UMI-B7 VFD can set 16-step speeds, which are selectable by multi-step speed terminals 1–4, corresponding to multi-step speed 0 to multi-step speed 15.

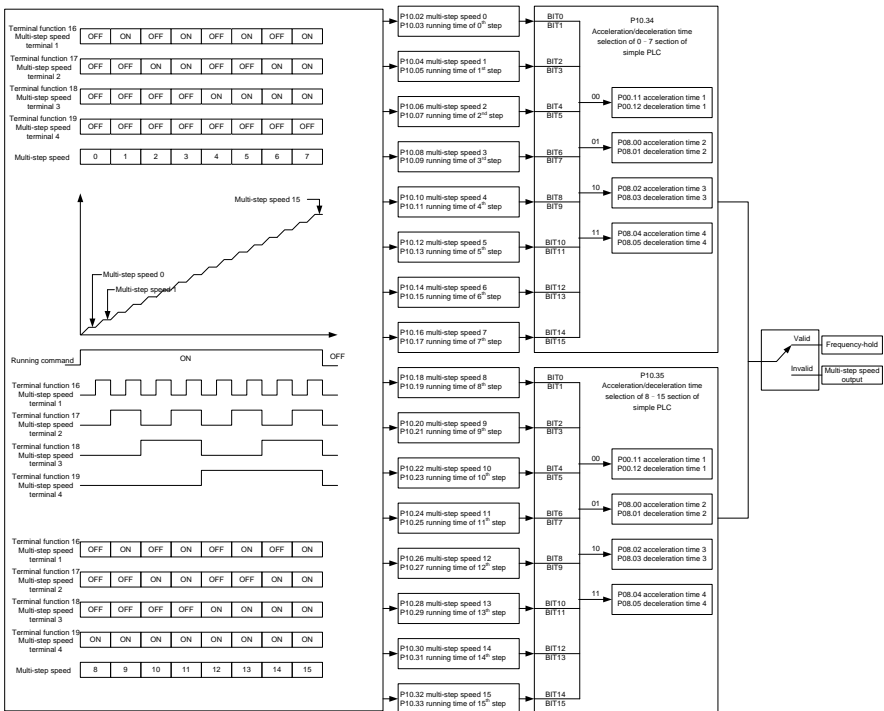

Related parameter list:

Function code	Name	Detailed parameter description	Default value
P05.01– P05.06	Digital input function selection	16: Multi-step speed terminal 1 17: Multi-step speed terminal 2 18: Multi-step speed terminal 3 19: Multi-step speed terminal 4 20: Multi-step speed pause	
P10.02	Multi-step speed 0	-300.0–300.0%	0.0%
P10.03	Running time of step 0	0.0–6553.5s (min)	0.0s
P10.04	Multi-step speed 1	-300.0–300.0%	0.0%
P10.05	Running time of step 1	0.0–6553.5s (min)	0.0s
P10.06	Multi-step speed 2	-300.0–300.0%	0.0%
P10.07	Running time of step 2	0.0–6553.5s (min)	0.0s
P10.08	Multi-step speed 3	-300.0–300.0%	0.0%
P10.09	Running time of step 3	0.0–6553.5s (min)	0.0s
P10.10	Multi-step speed 4	-300.0–300.0%	0.0%
P10.11	Running time of step 4	0.0–6553.5s (min)	0.0s
P10.12	Multi-step speed 5	-300.0–300.0%	0.0%
P10.13	Running time of step 5	0.0–6553.5s (min)	0.0s
P10.14	Multi-step speed 6	-300.0–300.0%	0.0%
P10.15	Running time of step 6	0.0–6553.5s (min)	0.0s
P10.16	Multi-step speed 7	-300.0–300.0%	0.0%
P10.17	Running time of step 7	0.0–6553.5s (min)	0.0s
P10.18	Multi-step speed 8	-300.0–300.0%	0.0%
P10.19	Running time of step 8	0.0–6553.5s (min)	0.0s
P10.20	Multi-step speed 9	-300.0–300.0%	0.0%
P10.21	Running time of step 9	0.0–6553.5s (min)	0.0s
P10.22	Multi-step speed 10	-300.0–300.0%	0.0%
P10.23	Running time of step 10	0.0–6553.5s (min)	0.0s
P10.24	Multi-step speed 11	-300.0–300.0%	0.0%
P10.25	Running time of step 11	0.0–6553.5s (min)	0.0s
P10.26	Multi-step speed 12	-300.0–300.0%	0.0%
P10.27	Running time of step 12	0.0–6553.5s (min)	0.0s
P10.28	Multi-step speed 13	-300.0–300.0%	0.0%
P10.29	Running time of step 13	0.0–6553.5s (min)	0.0s
P10.30	Multi-step speed 14	-300.0–300.0%	0.0%
P10.31	Running time of step 14	0.0–6553.5s (min)	0.0s
P10.32	Multi-step speed 15	-300.0–300.0%	0.0%
P10.33	Running time of step 15	0.0–6553.5s (min)	0.0s
P10.34	Acceleration/decoration	0x0000–0XFFFF	0000

Function code	Name	Detailed parameter description	Default value
	time selection of 0–7 section of simple PLC		
P10.35	Acceleration/decoration time selection of 8–15 section of simple PLC	0x0000–0xFFFF	0000
P17.27	Simple PLC and current steps of multi-step speed	0–15	0

**5.5.15 PID control**

PID control, a common mode for process control, is mainly used to adjust the VFD output frequency or output voltage by performing scale-division, integral and differential operations on the difference between feedback signal of controlled variables and signal of the target, thus forming a negative feedback system to keep the controlled variables above the target. It is applicable to flow control, pressure control, temperature control, and so on. The following is the basic schematic block diagram for output frequency regulation.

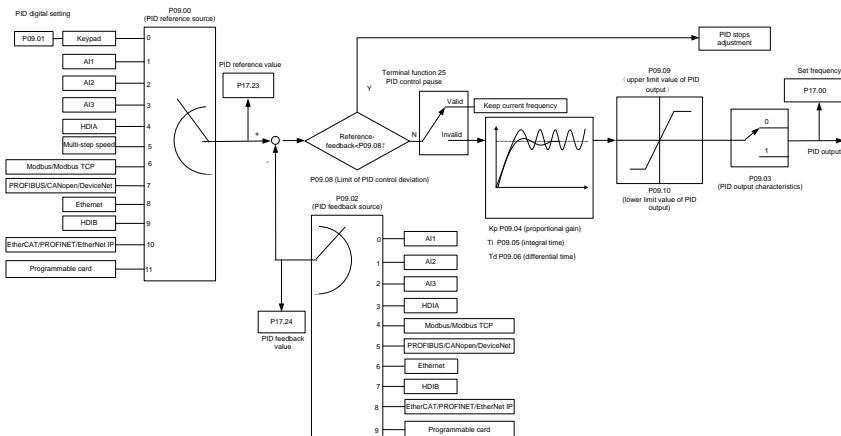

**Introduction to the working principles and control methods for PID control**

**Proportional control (Kp):** When the feedback is different from the reference, the output will be proportional to the difference. If such a difference is constant, the regulating variable will also be constant. Proportional control can respond to feedback changes rapidly. However, it cannot eliminate the difference by itself. A larger proportional gain indicates a faster regulating speed, but a too large gain will result in oscillation. To solve this problem, set the integral time to a large value and the differential time to 0, run the system only with proportional control, and then change the reference to observe the difference (that is, static difference) between the feedback signal and reference. If the static difference occurs in the direction of reference change (such as reference increase, where the feedback is always less than the reference after system stabilizes), continue increasing the

proportional gain; otherwise, decrease the proportional gain. Repeat this process until the static difference becomes small.

Integral time (Ti): When feedback deviates from reference, the output regulating variable accumulates continuously, if the deviation persists, the regulating variable will increase continuously until deviation disappears. Integral regulator can be used to eliminate static difference; however, too large regulation may lead to repetitive overshoot, which will cause system instability and oscillation. The feature of oscillation caused by strong integral effect is that the feedback signal fluctuates up and down based on the reference variable, and fluctuation range increases gradually until oscillation occurs. Integral time parameter is generally regulated gradually from large to small until the stabilized system speed fulfills the requirement.

Derivative time (Td): When the deviation between feedback and reference changes, output the regulating variable which is proportional to the deviation variation rate, and this regulating variable is only related to the direction and magnitude of the deviation variation rather than the direction and magnitude of the deviation itself. Differential control is used to control the feedback signal variation based on the variation trend. Differential regulator should be used with caution as it may easily enlarge the system interferences, especially those with high variation frequency.

When frequency command selection (P00.06, P00.07) is 7, or channel of voltage setting (P04.27) is 6, the running mode of VFD is process PID control.

#### **5.5.15.1 General procedures for PID parameter setting**

##### **a. Determining proportional gain P**

When determining proportional gain P, first, remove the integral term and derivative term of PID by making  $T_i=0$  and  $T_d=0$  (see PID parameter setting for details), thus turning PID into pure proportional control. Set the input to 60%–70% of the max. allowable value and increase proportional gain P gradually from 0 until system oscillation occurred, and then in turn, decrease proportional gain P gradually from current value until system oscillation disappears, record the proportional gain P at this point and set the proportional gain P of PID to 60%–70% of current value. This is whole commissioning process of proportional gain P.

##### **b. Determine integral time Ti**

After proportional gain P is determined, set the initial value of a larger integral time  $T_i$ , and decrease  $T_i$  gradually until system oscillation occurred, and then in turn, increase  $T_i$  until system oscillation disappears, record the  $T_i$  at this point, and set the integral time constant  $T_i$  of PID to 150%–180% of current value. This is the commissioning process of integral time constant  $T_i$ .

##### **c. Determining derivative time Td**

The derivative time  $T_d$  is generally set to 0.

If you need to set  $T_d$  to another value, set in the same way with P and  $T_i$ , namely set  $T_d$  to 30% of the value when there is no oscillation.

d. Empty system load, perform load-carrying joint debugging, and then fine-tune PID parameter until fulfilling the requirement.

**5.5.15.2 PID adjusting method**

After setting the parameters controlled by PID, you can adjust these parameters by the following means.

**Control overmodulation: When overmodulation occurs, shorten the derivative time (Td) and prolong integral time (Ti).**

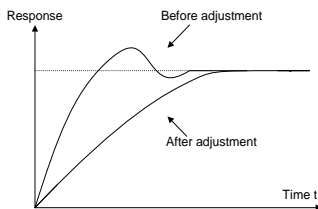

**Stabilize the feedback value as fast as possible:** when overmodulation occurs, shorten integral time (Ti) and prolong derivative time (Td) to stabilize control as fast as possible.

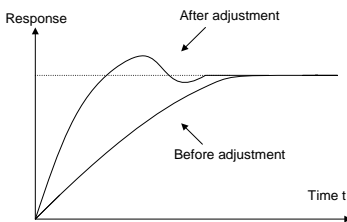

**Control long-term vibration:** If the cycle of periodic vibration is longer than the set value of integral time (Ti), it indicates the integral action is too strong, prolong the integral time (Ti) to control vibration.

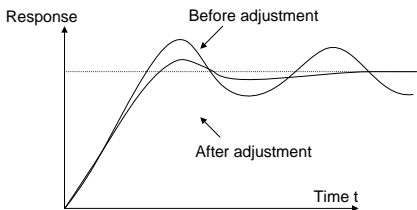

**Control short-term vibration:** If the vibration cycle is short is almost the same with the set value of derivative time (Td), it indicates derivative action is too strong, shortening the derivative time (Td) to control vibration. When derivative time (Td) is set to 0.00 (namely no derivative control), and there is no way to control vibration, decrease the proportional gain.



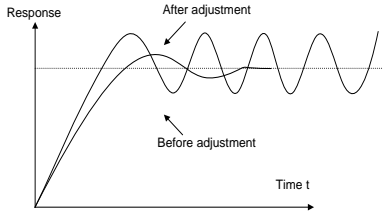

Related parameter list:

Function code	Name	Detailed parameter description	Default value
P09.00	PID reference source	0: Keypad (P09.01) 1: AI1 2: AI2 3: AI3 4: High-speed pulse HDIA 5: Multi-step 6: Modbus/Modbus TCP communication 7: CANopen communication 8: Ethernet communication 9: High-speed pulse HDIB 10: PROFINET/EtherNet IP communication 11: Programmable expansion card 12: Reserved	0
P09.01	Pre-set PID reference of keypad	-100.0%–100.0%	0.0%
P09.02	PID feedback source	0: AI1 1: AI2 2: AI3 3: High-speed pulse HDIA 4: Modbus/Modbus TCP communication 5: CANopen communication 6: Ethernet communication 7: High-speed pulse HDIB 8: PROFINET/EtherNet IP communication 9: Programmable expansion card 10: Reserved	0
P09.03	PID output characteristics	0: PID output is positive characteristic 1: PID output is negative characteristic	0
P09.04	Proportional gain (Kp)	0.00–100.00	1.80

Function code	Name	Detailed parameter description	Default value
P09.05	Integral time (Ti)	0.01–10.00s	0.90s
P09.06	Derivative time (Td)	0.00–10.00s	0.00s
P09.07	Sampling cycle (T)	0.001–1.000s	0.001s
P09.08	Limit of PID control deviation	0.0–100.0%	0.0%
P09.09	Upper limit value of PID output	P09.10–100.0% (max. frequency or voltage)	100.0%
P09.10	Lower limit value of PID output	-100.0%–P09.09 (max. frequency or voltage)	0.0%
P09.11	Feedback offline detection value	0.0–100.0%	0.0%
P09.12	Feedback offline detection time	0.0–3600.0s	1.0s
P09.13	PID control selection	0x0000–0x1111 Ones: 0: Continue integral control after the frequency reaches upper/lower limit 1: Stop integral control after the frequency reaches upper/lower limit Tens: 0: The same with the main reference direction 1: Contrary to the main reference direction Hundreds: 0: Limit as per the max. frequency 1: Limit as per A frequency Thousands: 0: A+B frequency, acceleration /deceleration of main reference A frequency source buffering is invalid 1: A+B frequency, acceleration/ deceleration of main reference A frequency source buffering is valid, acceleration/deceleration is determined by P08.04 (acceleration time 4).	0x0001
P09.14	Low frequency proportional gain (Kp)	0.00–100.00	1.00

Function code	Name	Detailed parameter description	Default value
P09.15	ACC/DEC time of PID command	0.0–1000.0s	0.0s
P09.16	PID output filter time	0.000–10.000s	0.000s
P09.17	Reserved	0–0	0
P09.18	Low frequency integral time (Ti)	0.00–10.00s	0.90s
P09.19	Low frequency differential time (Td)	0.00–10.00s	0.00s
P09.20	Low frequency point for PID parameter switching	0.00Hz–P09.21	5.00Hz
P09.21	High frequency point for PID parameter switching	P09.20–P00.03	10.00Hz
P17.00	Set frequency	0.00Hz–P00.03 (Max. output frequency)	0.00Hz
P17.23	PID reference value	-100.0–100.0%	0.0%
P17.24	PID feedback value	-100.0–100.0%	0.0%

**5.5.16 Run at wobbling frequency**

Wobbling frequency is mainly applied in cases where transverse movement and winding functions are needed like textile and chemical fiber industries. The typical working process is shown below.

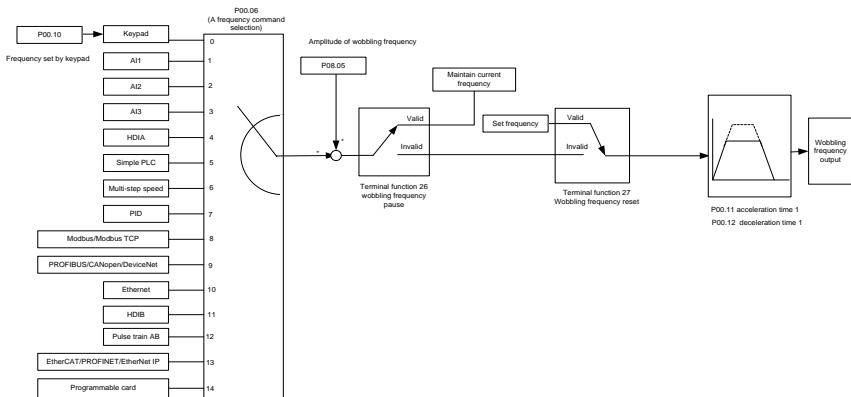

Function code	Name	Detailed parameter description	Default value
P00.03	Max. output frequency	Max.(P00.04, 10.00) – 630.00Hz	60.00Hz
P00.06	A frequency command selection	0: Set via keypad 1: Set via AI1	0

Function code	Name	Detailed parameter description	Default value
		2: Set via AI2 3: Set via AI3 4: Set via high-speed pulse HDIA 5: Set via simple PLC program 6: Set via multi-step speed running 7: Set via PID control 8: Set via Modbus/Modbus TCP communication 9: Set via CANopen communication 10: Set via Ethernet communication 11: Set via high speed pulse HDIB 12: Set via Pulse train AB 13: Set via EtherCAT/PROFINET/EtherNet IP communication 14: Set via programmable card	
P00.11	Acceleration time 1	0.0–3600.0s	Depends on model
P00.12	Deceleration time 1	0.0–3600.0s	Depends on model
P05.01–P05.06	Digital input function selection	26: Wobbling frequency pause (stop at current frequency) 27: Wobbling frequency reset (revert to center frequency)	/
P08.15	Amplitude of wobbling frequency	0.0–100.0% (relative to set frequency)	0.0%
P08.16	Amplitude of jump frequency	0.0–50.0% (relative to amplitude of wobbling frequency)	0.0%
P08.17	Wobbling frequency rise time	0.1–3600.0s	5.0s
P08.18	Wobbling frequency fall time	0.1–3600.0s	5.0s

**5.5.17 Local encoder input**

The UMI-B7 series VFD supports pulse count function by inputting the count pulse from HDI high-speed pulse port. When the actual count value is no less than the set value, digital output terminal will output count-value-reached pulse signal, and the corresponding count value will be zeroed out.

Function code	Name	Detailed parameter description	Default value
P05.00	HDI input type	0x00–0x11 Ones: HDIA input type 0: HDIA is high-speed pulse input 1: HDIA is digital input Tens: HDIB input type 0: HDIB is high-speed pulse input 1: HDIB is digital input	0x00
P05.38	HDIA high-speed pulse input function	0: Set input via frequency 1: Reserved 2: Input via encoder, used in combination with HDIB	0
P05.44	HDIB high-speed pulse input function selection	0: Set input via frequency 1: Reserved 2: Input via encoder, used in combination with HDIA	0
P20.15	Speed measurement mode	0: PG card 1: local; realized by HDIA and HDIB; supports incremental 24V encoder only	0
P18.00	Actual frequency of encoder	-999.9–3276.7Hz <b>Note:</b> P18.00 is displayed only in the V/F and closed-loop modes, but not in the open-loop mode.	0.0Hz

**5.5.18 Commissioning procedures for closed-loop control, position control and spindle positioning**

**1. Commissioning procedures for closed-loop vector control of asynchronous motor**

Step 1: Restore to default value via keypad

Step 2: Set P00.03, P00.04 and P02 group motor nameplate parameters

Step 3: Motor parameter autotuning

Carry out rotary parameter autotuning or static parameter autotuning via keypad. If the motor can be disconnected from load, then you can carry out rotary parameter autotuning; otherwise, carry out static parameter autotuning, the parameter obtained from autotuning will be saved in P02 motor parameter group automatically.

Step 4: Verify whether the encoder is installed and set properly

a) Confirm the encoder direction and parameter setting

Set P20.01 (encoder pulse-per-revolution), set P00.00=2 and P00.10=20.00Hz, and run the VFD, at this point, the motor rotates at 20.00Hz, observe whether the speed measurement value of

P18.00 is correct, if the value is negative, it indicates the encoder direction is reversed, under such situation, set P20.02 to 1; if the speed measurement value deviates greatly, it indicates P20.01 is set improperly. Observe whether P18.02 (encoder Z pulse count value) fluctuates, if yes, it indicates the encoder suffers interference or P20.01 is set improperly, requiring the check of the wiring and the shielding layer.

b) Determine Z pulse direction

Set P00.10=20.00Hz, and set P00.13 (running direction) to forward and reverse direction respectively to observe whether the difference value of P18.02 is less than 5, if the difference value remains to be larger than 5 after setting Z pulse reversal function of P20.02, power off and exchange phase A and phase B of the encoder, and then observe the difference between the value of P18.02 during forward and reverse rotation. Z pulse direction only affects the forward/reverse positioning precision of the spindle positioning carried out with Z pulse.

Step 5: Closed-loop vector pilot run

Set P00.00=3, and carry out closed-loop vector control, adjust P00.10 and speed loop and current loop PI parameter in P03 group to make it run stably in the whole range.

Step 6: Flux-weakening control

Set flux-weakening regulator gain P03.26=0–8000 and observe the flux-weakening control effect. P03.22–P03.24 can be adjusted as needed.

## 2. Commissioning procedures for closed-loop vector control of synchronous motor

Step 1: Set P00.18=1, restore to default value

Step 2: Set P00.00=3 (closed-loop vector control), set P00.03, P00.04, and motor nameplate parameters in P02 group.

Step 3: Set P20.00 and P20.01 encoder parameters

When the encoder is resolver-type encoder, set the encoder pulse count value to (resolver pole pair number × 1024), for example, if pole pair number is 4, set P20.01 to 4096.

Step 4: Ensure the encoder is installed and set correctly

When the motor stops, observe whether P18.21 (resolver angle) fluctuates, if it fluctuates sharply, check the wiring and grounding. Rotates the motor slowly, observe whether P18.21 changes accordingly. If yes, it indicates motor is connected correctly; if the value of P18.02 keeps constant at a non-zero value after rotating for multiple circles, it indicates encoder Z signal is correct.

Step 5: Autotuning of initial position of magnetic pole

Set P20.11=2 or 3 (3: rotary autotuning; 2: static autotuning), press RUN key to run the VFD.

a) Rotary autotuning (P20.11 = 3)

Detect the position of current magnetic pole when autotuning starts, and then accelerates to 10Hz, autotuning corresponding magnetic pole position of encoder Z pulse, and decelerate to stop.

During running, if ENC1o or ENC1d fault occurred, set P20.02=1 and carry out autotuning again. After autotuning is done, the angle obtained from autotuning will be saved in P20.09 and P20.10 automatically.

#### b) Static autotuning

In cases where the load can be disconnected, it is recommended to adopt rotary autotuning (P20.11=3) as it has high angle precision. If the load cannot be disconnected, you can adopt static autotuning (P20.11=2). The magnetic pole position obtained from autotuning will be saved in P20.09 and P20.10.

#### Step 6: Closed-loop vector pilot run

Adjust P00.10 and speed loop and current loop PI parameter in P03 group to make it run stably in the whole range. If oscillation occurs, reduce the value of P03.00, P03.03, P03.09 and P03.10. If current oscillation noise occurred during low speed, adjust P20.05.

**Note:** It is necessary to re-determine P20.02 (encoder direction) and carry out magnetic pole position autotuning again if the wiring of motor or encoder is changed.

### 3. Commissioning procedures for pulse train control

Pulse input is operated based on closed-loop vector control; speed detection is needed in the subsequent spindle positioning, zeroing operation and division operation.

Step 1: Restore to default value by keypad

Step 2: Set P00.03, P00.04 and motor nameplate parameters in P02 group

Step 3: Motor parameter autotuning: rotary parameter autotuning or static parameter autotuning

Step 4: Verify the installation and settings of encoder. Set P00.00=3 and P00.10=20Hz to run the system and check the control effect and performance of the system.

Step 5: Set P21.00=0001 to set positioning mode to position control, namely pulse-string control. There are four kinds of pulse command modes, which can be set by P21.01 (pulse command mode).

Under position control mode, you can check high bit and low bit of position reference and feedback, P18.02 (count value of Z pulse), P18.00 (actual frequency of encoder), P18.17 (pulse command frequency) and P18.19 (position regulator output) via P18, through which you can figure out the relation between P18.8 (position of position reference point) and P18.02, pulse command frequency P18.17, feedforward P18.18 and position regulator output P18.19.

Step 6: The position regulator has two gains, namely P21.02 and P21.03, and they can be switched by speed command, torque command and terminals.

Step 7: When P21.08 (output limit of position controller) is set to 0, the position control will be invalid, and at this point, the Pulse train acts as frequency source, P21.13 (position feedforward gain) should be set to 100%, and the speed acceleration/deceleration time is determined by the acceleration /deceleration time of Pulse train, the Pulse train acceleration/deceleration time of the system can be

adjusted. If the Pulse train acts as the frequency source in speed control, you can also set P21.00 to 0000, and set the frequency source reference P00.06 or P00.07 to 12 (set by Pulse train AB), at this point, the acceleration/deceleration time is determined by the acceleration/deceleration time of the VFD, meanwhile, the parameters of Pulse train AB is still set by P21 group. In speed mode, the filter time of Pulse train AB is determined by P21.29.

Step 8: The input frequency of Pulse train is the same with the feedback frequency of encoder pulse, the relation between them can be changed by altering P21.11 (numerator of position command ratio) and P21.12 (denominator of position command ratio)

Step 9: When running command or servo enabling is valid (by setting P21.00 or terminal function 63), it will enter Pulse train servo running mode.

#### 4. Commissioning procedures for spindle positioning

Spindle orientation is to realize orientation functions like zeroing and division based on closed-loop vector control

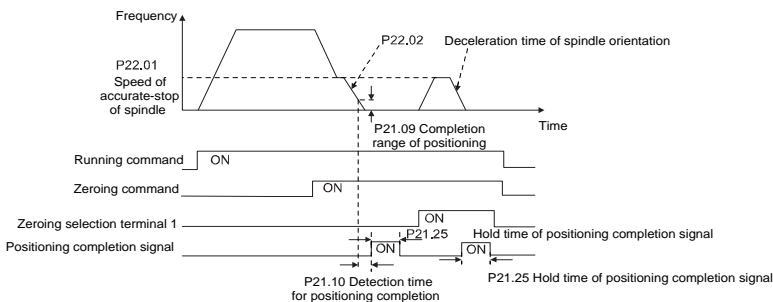

Step 1–4: These four steps are the same with the first four steps of the commissioning procedures for closed-loop vector control, which aim to fulfill the control requirements of closed-loop vector control, thus realizing spindle positioning function in either position control or speed control mode.

Step 5: Set P22.00 bit0=1 to enable spindle positioning, set P22.00 bit1 to select spindle zero input. If the system adopts encoder for speed measurement, set P22.00 bit1 to 0 to select Z pulse input; if the system adopts photoelectric switch for speed measurement, set P22.00 bit1 to 1 to select photoelectric switch as zero input; set P22.00 bit2 to select zero search mode, set P22.00 bit3 to enable or disable zero calibration, and select zero calibration mode by setting P22.00 bit7.

Step 6: Spindle zeroing operation

- a) Select the positioning direction by setting P22.00 bit4;
- b) There are four zero positions in P22 group, you can choose one out of four zeroing positions by setting zeroing input terminal selection (46, 47) in P05 group. When executing zeroing function, the motor will stop accurately at corresponding zeroing position according to the set positioning direction, which can be viewed via P18.10;



c) The positioning length of spindle zeroing is determined by the deceleration time of accurate-stop and the speed of accurate stop;

#### Step 7: Spindle division operation

There are seven scale-division positions in P22 group, you can choose one out of seven scale-division positions by setting scale-division input terminal selection (48, 49, 50) in P05 group. Enable corresponding scale-division terminal after the motor stops accurately, and the motor will check the scale-division position state and switch to corresponding position incrementally, at this point, you can check P18.09.

#### Step 8: Priority level of speed control, position control and zeroing

The priority level of speed running is higher than that of the scale division, when the system runs in scale-division mode, if spindle orientation is prohibited, the motor will turn to speed mode or position mode.

The priority level of zeroing is higher than that of the scale division.

Scale-division command is valid when the scale-division terminal is from 000 state to non-000 state, for example, in 000–011, the spindle executes scale division 3. The transition time during terminal switchover needs to be less than 10ms; otherwise, wrong scale division command may be executed.

#### Step 9: Hold positioning

The position loop gain during positioning is P21.03; while the position loop gain in positioning-completion-hold state is P21.02. To keep sufficient position-hold force and ensure no system oscillation occurred, adjust P03.00, P03.01, P20.05 and P21.02.

#### Step 10: Positioning command selection (bit6 of P22.00)

Electric level signal: Positioning command (zeroing and scale division) can be executed only when there is running command, or the servo is enabled.

#### Step 11: Spindle reference point selection (bit0 of P22.00)

Encoder Z pulse positioning supports the following spindle positioning modes:

- a) the encoder is installed on the motor shaft, the motor shaft and spindle is 1:1 rigid connection;
- b) the encoder is installed on the motor shaft, the motor shaft and spindle is 1:1 belt connection;

At this point, the belt may slip during high-speed running and cause inaccurate positioning, it is recommended to install proximity switch on the spindle.

- c) The encoder is installed on the spindle, and the motor shaft is connected to the spindle with belt, the drive ratio is not necessarily 1:1;

At this point, set P20.06 (speed ratio of the mounting shaft between motor and encoder), and set P22.14 (spindle drive ratio) to 1. As the encoder is not installed on the motor, the control performance of closed-loop vector will be affected.

Proximity switch positioning supports the following spindle positioning modes:

d) The encoder is installed on the motor shaft, the drive ratio between motor shaft and spindle is not necessarily 1:1;

At this point, it is required to set P22.14 (spindle drive ratio).

### 5. Commissioning procedures for digital positioning

The diagram for digital positioning is shown below.

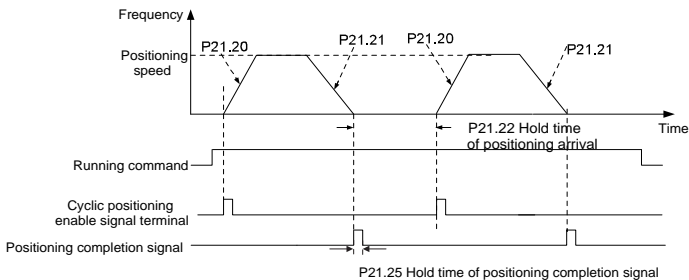

Step 1–4: These four steps are the same as the first four steps of the commissioning procedures for closed-loop vector control, which aim to fulfill the control requirements of closed-loop vector control.

Step 5: Set P21.00=0011 to enable digital positioning. Set P21.17, P21.11 and P21.12 (set positioning displacement) according to actual needs; set P21.18 and P21.19 (set positioning speed); set P21.20 and P21.21 (set acceleration/deceleration time of positioning).

Step 6: Single positioning operation

Set P21.16 bit1=0, and the motor will carry out single positioning action and stay in the positioning position according to the setting in step 5.

Step 7: Cyclic positioning operation

Set P21.16 bit1=1 to enable cyclic positioning. The cyclic positioning is divided into continuous mode and repetitive mode; you can also carry out cyclic positioning through terminal function (no. 55, enable digital positioning cycle)

### 6. Commissioning procedures for positioning of photoelectric switch

Photoelectric switch positioning is to realize positioning function based on closed-loop vector control.

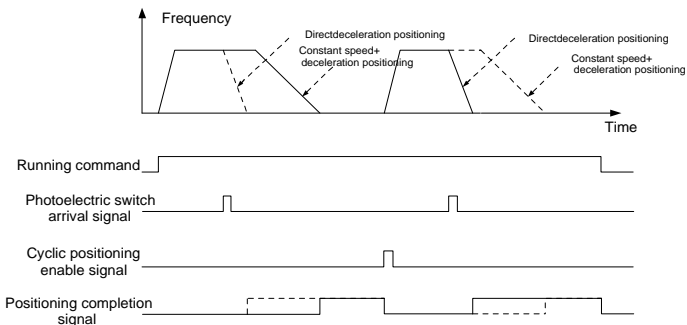

Step 1–4: These four steps are the same as the first four steps of the commissioning procedures for closed-loop vector control, which aim to fulfill the control requirements of closed-loop vector control.

Step 5: Set P21.00=0021 to enable photoelectric switch positioning, the photoelectric switch signal can be connected to S8 terminal only, and set P05.08=43, meanwhile, set P21.17, P21.11 and P21.12 (set positioning displacement) based on actual needs; set P21.21 (deceleration time of positioning), however, when present running speed is too fast or the set positioning displacement is too small, the deceleration time of positioning will be invalid, and it will enter direct deceleration positioning mode.

Step 6: Cyclic positioning

After positioning is done, the motor will stay in its current position. You can set cyclic positioning through input terminal function selection (55: enable cyclic digital positioning) in P05 group; when the terminal receives cyclic positioning enable signal (pulse signal), the motor will continue running in the set speed as per the speed mode and re-enter positioning state after encountering photoelectric switch.

(7) Hold positioning

The position loop gain during positioning is P21.03; while the position loop gain in positioning-completion-hold state is P21.02. To keep sufficient position-hold force and ensure no system oscillation occurred, adjust P03.00, P03.01, P20.05 and P21.02.

**5.5.19 Fault handling**

The following provides fault handling information.

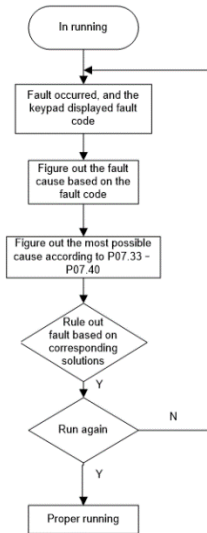

Related parameter list:

Function code	Name	Detailed parameter description	Default value
P07.27	Type of present fault	0: No fault	0
P07.28	Type of the last fault	1: VFD unit U phase protection (OUt1)	0
P07.29	Type of the 2nd-last fault	2: VFD unit V phase protection (OUt2)	0
P07.30	Type of the 3rd-last fault	3: VFD unit W phase protection (OUt3)	0
P07.31	Type of the 4th-last fault	4: Overcurrent during acceleration (OC1)	0
P07.32	Type of the 5th-last fault	5: Overcurrent during deceleration (OC2) 6: Overcurrent during constant speed (OC3) 7: Overvoltage during acceleration (OV1) 8: Overvoltage during deceleration (OV2) 9: Overvoltage during constant speed (OV3) 10: Bus undervoltage fault (UV) 11: Motor overload (OL1) 12: VFD overload (OL2) 13: Phase loss on input side (SPI) 14: Phase loss on output side (SPO) 15: Rectifier module overheat (OH1) 16: Inverter module overheat (OH2)	0

Function code	Name	Detailed parameter description	Default value
		17: External fault (EF) 18: Modbus/Modbus TCP communication fault (CE) 19: Current detection fault (ItE) 20: Motor autotuning fault (tE) 21: EEPROM operation fault (EEP) 22: PID feedback offline fault (PIDE) 23: Brake unit fault (bCE) 24: Running time reached (END) 25: Electronic overload (OL3) 26: Keypad communication error (PCE) 27: Parameter upload error (UPE) 28: Parameter download error (DNE) 30: Ethernet communication fault (E-NET) 31: CANopen communication fault (E-CAN) 32: To-ground short-circuit fault 1 (ETH1) 33: To-ground short-circuit fault 2 (ETH2) 34: Speed deviation fault (dEu) 35: Mal-adjustment fault (STo) 36: Underload fault (LL) 37: Encoder offline fault (ENC1o) 38: Encoder reversal fault (ENC1d) 39: Encoder Z pulse offline fault (ENC1Z) 40: Safe torque off (STO) 41: Channel H1 safety circuit exception (STL1) 42: Channel H2 safety circuit exception (STL2) 43: Channel H1 and H2 exception (STL3) 44: Safety code FLASH CRC check fault (CrCE) 55: Repetitive expansion card type fault (E-Err)	

Function code	Name	Detailed parameter description	Default value
		56: Encoder UVW loss fault (ENCUV) 57: PROFINET communication timeout fault (E-PN) 58: CAN communication fault (SECAN) 59: Motor over-temperature fault (OT) 60: Card slot 1 card identification failure (F1-Er) 61: Card slot 2 card identification failure (F2-Er) 62: Card slot 3 card identification failure (F3-Er) 63: Card slot 1 card communication timeout fault (C1-Er) 64: Card slot 2 card communication timeout fault (C2-Er) 65: Card slot 3 card communication timeout fault (C3-Er) 66: EtherCAT communication fault (E-CAT) 69: Master-slave synchronous CAN slave fault (S-Err) 70: EC PT100 detected overheating (OtE1) 71: EC PT1000 detected overheating (OtE2) 72: EtherNet/IP communication timeout (E-EIP) 73: No upgrade bootloader (E-PAO) 74: AI1 disconnected (E-AI1) 75: AI2 disconnected (E-AI2) 76: AI3 disconnected (E-AI3) 77: AI/AO detected overheating (OH3) 78: Brake feedback fault (E-brF) 79: Stalling in V/F control (E-StK) 80: Out-of-step in V/F control (E-LSt)	
P07.33	Running frequency at present fault	0.00Hz–P00.03	0.00Hz
P07.34	Ramp reference frequency at present fault	0.00Hz–P00.03	0.00Hz

Function code	Name	Detailed parameter description	Default value
P07.35	Output voltage at present fault	0–1200V	0V
P07.36	Output current at present fault	0.0–6300.0A	0.0A
P07.37	Bus voltage at present fault	0.0–2000.0V	0.0V
P07.38	Max. temperature at present fault	-20.0–120.0°C	0.0°C
P07.39	Input terminal state at present fault	0x0000–0xFFFF	0
P07.40	Output terminal state at present fault	0x0000–0xFFFF	0
P07.41	Running frequency at the last fault	0.00Hz–P00.03	0.00Hz
P07.42	Ramp reference frequency at the last fault	0.00Hz–P00.03	0.00Hz
P07.43	Output voltage at the last fault	0–1200V	0V
P07.44	Output current at the last fault	0.0–6300.0A	0.0A
P07.45	Bus voltage at the last fault	0.0–2000.0V	0.0V
P07.46	Max. temperature at the last fault	-20.0–120.0°C	0.0°C
P07.47	Input terminal state at the last fault	0x0000–0xFFFF	0x0000
P07.48	Output terminal state at the last fault	0x0000–0xFFFF	0x0000
P07.49	Running frequency at the 2nd-last fault	0.00Hz–P00.03	0.00Hz
P07.50	Ramp reference frequency at the 2nd-last fault	0.00Hz–P00.03	0.00Hz
P07.51	Output voltage at the 2nd-last fault	0–1200V	0V
P07.52	Output current at the 2nd-last fault	0.0–6300.0A	0.0A
P07.53	Bus voltage at the 2nd-last fault	0.0–2000.0V	0.0V
P07.54	Max. temperature at the 2nd-last fault	-20.0–120.0°C	0.0°C

Function code	Name	Detailed parameter description	Default value
P07.55	Input terminal state at the 2nd-last fault	0x0000–0xFFFF	0x0000
P07.56	Output terminal state at the 2nd-last fault	0x0000–0xFFFF	0x0000

**5.5.20 Tension control solutions**

In many fields of industrial production, precise tension control is needed to maintain a constant output tension of the drive equipment, to improve the quality of the products. In the winding and unwinding of some industries such as paper processing, printing, and dyeing, packing, wire and cable manufacturing, textile, fiber, optic cable, leather, metal foil material processing and so on, tension needs to keep constant.

The VFD controls the tension by regulating the motor output torque or speed. There are three modes to control the tension: speed mode, open-loop torque mode and closed-loop torque mode.



5.5.20.1 Typical tension control applications for winding/unwinding

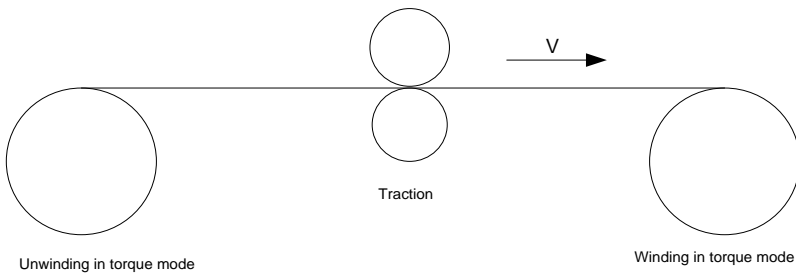
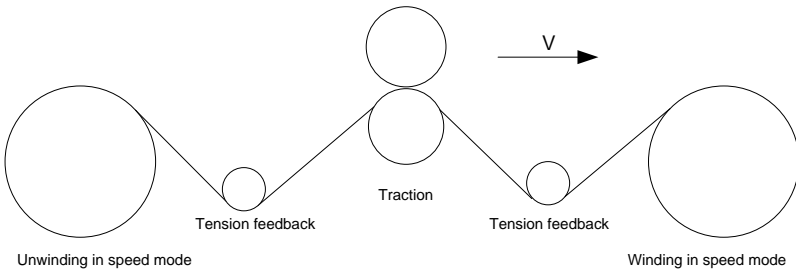
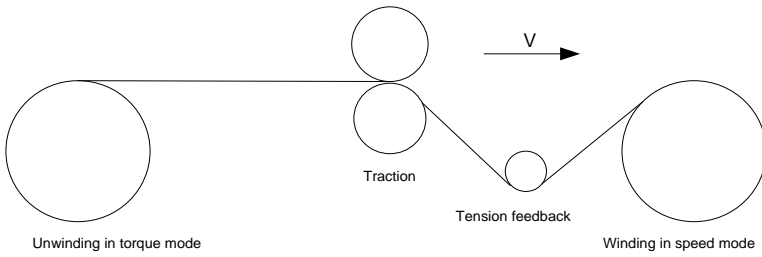
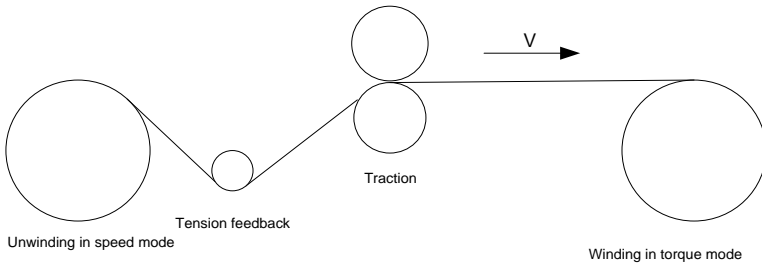

In some special situations, if the roll diameter can be counted through thickness, the following

applications can be implemented:

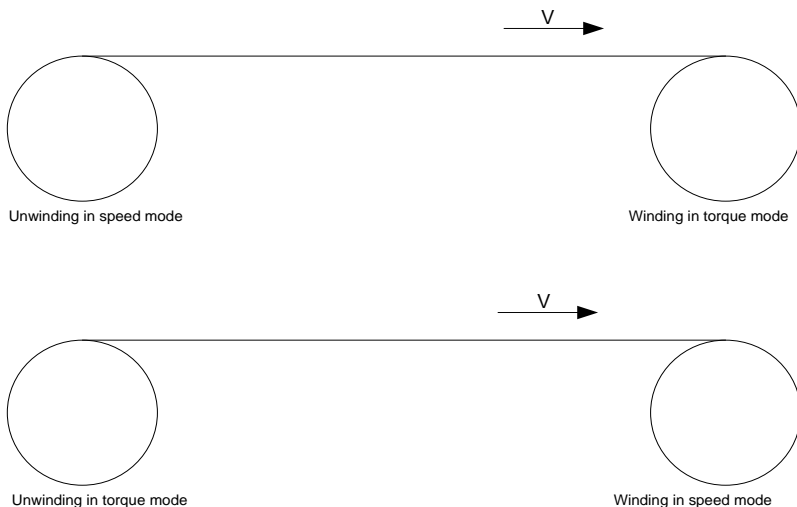

**5.5.20.2 Speed control**

The detection feedback signal is needed in the closed-loop adjustment. PID calculation is carried out according to the feedback signal for the motor speed regulation, linear speed and stable tension control. If the tension rocker or floating roller is used for feedback, changing the set value (PID reference) may change the actual tension, and at the same time, changing the mechanical configuration such as the tension rocker or floating roller weight can also change the tension.

The control principle is as follows.

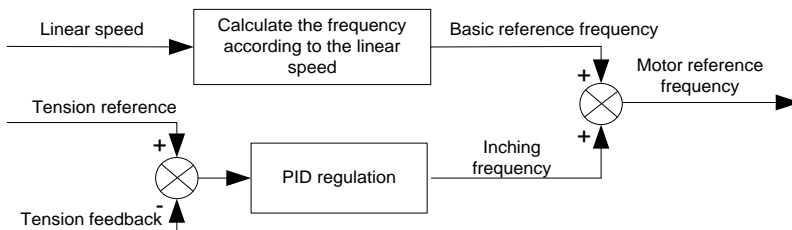

Related modules:

- (1) Linear speed input module: It is important for the calculation of the basic setting frequency according to the linear speed and the calculation of roll diameter according to the linear speed.
- (2) Real-time roll diameter calculation module: The calculation accuracy of roll diameter determines the control performance. The roll diameter can be calculated according to the VFD output frequency

and the linear speed. In addition, it can also be calculated through the thickness or sensor. Linear speed is widely used for the calculation. If the set linear speed is used for the calculation, you can choose whether to enable the function of roll diameter change limiting.

(3) PID regulation module: There are two groups of PID parameters in P09. The linear speed synchronization and stable tension can be kept through PID regulation. PID parameters can be modified based on site commissioning. The two groups of PID parameters can be switched for PID regulation improvement.

(4) Material feeding interrupt detection and processing module: The function is valid when material feeding interrupt detection has been enabled.

(5) Pre-drive: This function is applied to automatic reel change. After the VFD is started if the pre-drive function terminal is valid, the roller runs at the set linear speed. If the terminal is invalid, the VFD will automatically switch to the corresponding control mode after a period of time.

**5.5.20.3 Open-loop torque mode**

Open loop means there is no tension feedback signal. In this mode, stable tension can be achieved by means of motor torque control. The rotation speed automatically changes with the linear speed of material. The control basis is as follows: For a reel control system, the relationship between the tension  $F$  of the roller with materials, present roll diameter  $D$  and output torque of the shaft is:  $T = F \times D / 2$ . If the output torque can be adjusted according to the variation of roll diameter, the tension can be controlled. In order to ensure the constant tension in the process of acceleration and deceleration, the internal friction compensation module and inertia compensation module have been built in the VFD to calculate the real time rotation inertia and compensate the torque according to the actual speed change rate. The control principle is shown in the following figure.

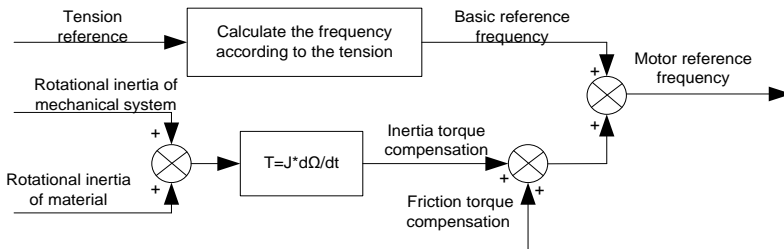

Relevant modes:

(1) Linear speed input module: It has two functions: calculating the synchronous frequency in torque control according to the linear speed and calculating the roll diameter according to the linear speed.

(2) Tension setting module: Used to set the tension adapting to the control system. It needs to be adjusted according to the actual situation. After confirmation, the value remains the same. In some scenarios where the forming effect after winding needs to be improved, the tension taper function can be used so that the tension decreases as the roll diameter increases.

(3) Real-time roll diameter calculation module: The calculation accuracy of roll diameter determines the control performance. The roll diameter can be calculated according to the VFD output frequency and the linear speed. In addition, it can also be calculated through the thickness or sensor. Linear speed is widely used for the calculation. If the set linear speed is used for the calculation, you can choose whether to enable the function of roll diameter change limiting.

(4) Torque compensation module: Torque compensation include friction torque compensation and inertia torque compensation. Friction torque compensation is used to eliminate the impact of friction on tension, and it needs to be adjusted according to actual requirements. Rotation inertia includes inertial of mechanical systems and that of materials. To keep the tension stable in ACC/DEC, compensation torque is required. In some cases, without strict tension control requirements, disabling rotation inertia torque compensation can also achieve the control.

(5) Material feeding interrupt detection and processing module: The function is valid when material feeding interrupt detection has been enabled.

(6) This function is applied to automatic reel change. After the VFD is started if the pre-drive function terminal is valid, the roller runs at the set linear speed. If the terminal is invalid, the VFD will automatically switch to the corresponding control mode after a period of time.

**5.5.20.4 Closed-loop torque mode**

Like the open-loop torque mode, the closed-loop torque mode has only the difference that tension detection sensors are installed on the winding/unwinding side. In addition to all the function modules supported in open-loop torque mode, this mode supports an additional tension feedback PID closed-loop regulation module. The control principle is shown in the following figure.

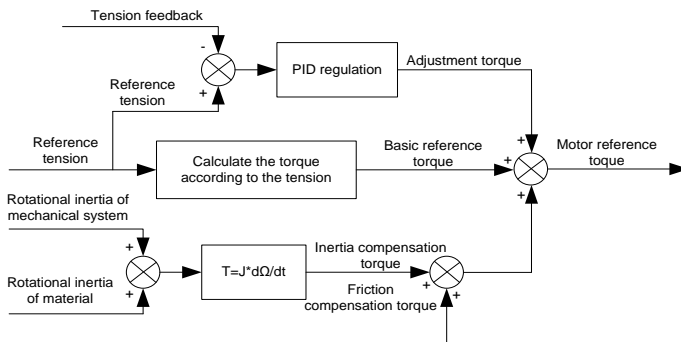

## 6 Function parameter list

### 6.1 What this chapter contains

This chapter lists all the function codes and corresponding description of each function code.

### 6.2 Function parameter list

Function parameters of the UMI-B7 series VFD are categorized according to functions. Among the function groups, P98 is analog input/output calibration group, and P99 is factory function group which are user inaccessible. The function code adopts three-level menu, such as, "P08.08" indicates it is the no. 8 function code in P08 group.

The function group no. corresponds to the first-level menu; function code no. corresponds to the second-level menu; function code parameter corresponds to the third-level menu.

1. The function list is divided into the following columns.

Column 1 "Function code": number of the function parameter group and the parameter;

Column 2 "Name": complete name of the function parameter;

Column 3 "Detailed parameter description": detailed description of this function parameter;

Column 4 "Default value": The original set value of the function parameter by default;

Column 5: "Modify": The modification attribute of the function parameter, namely whether the function parameter can be modified and the condition for modification, as shown below.

"○": the set value of this parameter can be modified when the VFD is in stop or running state;

"◉": the set value of this parameter cannot be modified when the VFD is in running state;

"●": the parameter value is the measured value which cannot be modified.

(The VFD automatically checks and constrains the modification of parameters, which helps prevent incorrect modifications.)

2. "System of numeration for parameters" is decimal; if the parameter is presented in hexadecimal numbers, the data of each bit will be independent of each other during parameter edit, and the value range of partial bits can be 0–F in hexadecimal system.
3. "Default value" is value restored after parameter refresh during restoring to default value; however, the measured value or recorded value will not be refreshed.
4. To enhance parameter protection, the VFD provides the password protection function. After a user password is set (that is, P07.00 is set to a non-zero value), "0.0.0.0.0" is displayed when you press the **PRG/ESC** key to enter the function code editing interface, and you can enter the interface only with the correct user password. For the factory parameters, you need to enter the correct factory password to enter the interface. (You are not advised to modify the factory parameters. Incorrect parameter setting may cause operation exceptions or even damage to the VFD.) If password protection is not in a locked state, you can change the password any time. You can set P07.00 to 0 to cancel the user password. When P07.00 is set to a non-zero value during power-on, parameters are

prevented from being modified by using the user password function. When you modify function parameters through serial communication, the user password protection function is also applicable and compliant with the same rule.

**P00 group—Basic functions**

Function code	Name	Detailed parameter description	Default value	Modify
P00.00	Speed control mode	0: SVC 0 1: SVC 1 2: SVPWM 3: FVC <b>Note:</b> To select 0, 1, or 3 as the control mode, enable the VFD to perform motor parameter autotuning first	2	⊙
P00.01	Channel of running commands	0: Keypad 1: Terminal 2: Communication	0	○
P00.02	Communication mode of running commands	0: Modbus/Modbus TCP 1: CANopen 2: Ethernet 3: EtherCAT/PROFINET/EtherNet IP 4: Programmable card 5: Wireless communication card 6: Reserved <b>Note:</b> 1, 2, 3, 4 and 5 are extended functions which are applicable with corresponding cards.	0	○
P00.03	Max. output frequency	Used to set the maximum output frequency of the VFD. It is the basis of frequency setting and the acceleration/deceleration. Setting range: Max.(P00.04, 10.00) – 630.00Hz	60.00Hz	⊙
P00.04	Upper limit of running frequency	The upper limit of running frequency is upper limit value of VFD output frequency. This value cannot be more than the maximum output frequency. When the set frequency is higher than the upper limit frequency, the VFD runs at the upper limit frequency. Setting range: P00.05–P00.03 (Max. output frequency)	60.00Hz	⊙
P00.05	Lower limit of running frequency	The lower limit of running frequency is the lower limit value of VFD output frequency. When the set frequency is lower than the lower	0.00Hz	⊙

Function code	Name	Detailed parameter description	Default value	Modify
		limit frequency, the VFD runs at the lower limit frequency. <b>Note:</b> Max. output frequency $\geq$ upper limit frequency $\geq$ lower limit frequency. Setting range: 0.00Hz–P00.04 (upper limit of running frequency)		
P00.06	A frequency command selection	0: Set via keypad 1: Set via AI1 2: Set via AI2	0	<input type="radio"/>
P00.07	B frequency command selection	3: Set via AI3 4: Set via high-speed pulse HDIA 5: Set via simple PLC program 6: Set via multi-step speed running 7: Set via PID control 8: Set via Modbus/Modbus TCP communication 9: Set via CANopen communication 10: Set via Ethernet communication 11: Set via high-speed pulse HDIB 12: Set via Pulse train AB 13: Set via EtherCAT/PROFINET/EtherNet IP communication 14: Set via programmable card 15: Reserved	15	<input type="radio"/>
P00.08	Reference object of B frequency command	0: Max. output frequency 1: A frequency command	0	<input type="radio"/>
P00.09	Combination mode of setting source	0: A 1: B 2: (A+B) 3: (A-B) 4: Max. (A, B) 5: Min. (A, B)	0	<input type="radio"/>
P00.10	Set frequency via keypad	When A and B frequency commands are set by keypad, the value is the initial digital set value of the VFD frequency. Setting range: 0.00 Hz–P00.03 (Max. output frequency)	60.00Hz	<input type="radio"/>
P00.11	Acceleration time 1	Acceleration time is the time needed for accelerating from 0Hz to Max. output frequency	Depends on model	<input type="radio"/>

Function code	Name	Detailed parameter description	Default value	Modify																																		
P00.12	Deceleration time 1	<p>(P00.03). Deceleration time is the time needed from decelerating from Max. output frequency (P00.03) to 0Hz. The VFD defines four groups of acceleration and deceleration time, which can be selected via multifunction digital input terminals (P05 group). The acceleration/deceleration time of the VFD is the first group by default. Setting range of P00.11 and P00.12: 0.0–3600.0s</p>	Depends on model	<input type="radio"/>																																		
P00.13	Running direction	<p>0: Run in default direction 1: Run in reverse direction 2: Reverse running is prohibited</p>	0	<input type="radio"/>																																		
P00.14	Carrier frequency setting	<table border="1" style="width: 100%; border-collapse: collapse; text-align: center;"> <thead> <tr> <th style="width: 15%;">Carrier frequency</th> <th style="width: 20%;">Electro magnetic noise</th> <th style="width: 20%;">Noise and leakage current</th> <th style="width: 20%;">Cooling level</th> </tr> </thead> <tbody> <tr> <td>1kHz</td> <td>↑ High</td> <td>↑ Low</td> <td>↑ Low</td> </tr> <tr> <td>10kHz</td> <td>↑</td> <td>↑</td> <td>↑</td> </tr> <tr> <td>15kHz</td> <td>↓ Low</td> <td>↓ High</td> <td>↓ High</td> </tr> </tbody> </table> <p>The relation between the model and carrier frequency is shown below.</p> <table border="1" style="width: 100%; border-collapse: collapse; text-align: center;"> <thead> <tr> <th colspan="2">Model</th> <th>Factory value of carrier frequency</th> </tr> </thead> <tbody> <tr> <td rowspan="2">220V</td> <td>0.75–55kW</td> <td>2kHz</td> </tr> <tr> <td>1.5–11kW</td> <td>8kHz</td> </tr> <tr> <td rowspan="2">460V</td> <td>15–55kW</td> <td>4kHz</td> </tr> <tr> <td>75–500kW</td> <td>2kHz</td> </tr> <tr> <td rowspan="2">575V</td> <td>22–55kW</td> <td>4kHz</td> </tr> <tr> <td>75–110kW</td> <td>2kHz</td> </tr> </tbody> </table> <p>Advantages of high carrier frequency are as follows: ideal current waveform, few current harmonics and small motor noise. Disadvantages of high carrier frequency are as follows: growing switch consumption, enlarged temperature rise, impacted output capacity; under high carrier frequency, the VFD needs to be derated for use, meanwhile, the leakage current</p>	Carrier frequency	Electro magnetic noise	Noise and leakage current	Cooling level	1kHz	↑ High	↑ Low	↑ Low	10kHz	↑	↑	↑	15kHz	↓ Low	↓ High	↓ High	Model		Factory value of carrier frequency	220V	0.75–55kW	2kHz	1.5–11kW	8kHz	460V	15–55kW	4kHz	75–500kW	2kHz	575V	22–55kW	4kHz	75–110kW	2kHz	Depends on model	<input type="radio"/>
Carrier frequency	Electro magnetic noise	Noise and leakage current	Cooling level																																			
1kHz	↑ High	↑ Low	↑ Low																																			
10kHz	↑	↑	↑																																			
15kHz	↓ Low	↓ High	↓ High																																			
Model		Factory value of carrier frequency																																				
220V	0.75–55kW	2kHz																																				
	1.5–11kW	8kHz																																				
460V	15–55kW	4kHz																																				
	75–500kW	2kHz																																				
575V	22–55kW	4kHz																																				
	75–110kW	2kHz																																				



Function code	Name	Detailed parameter description	Default value	Modify
		<p>will increase, which increases electromagnetic interference to the surroundings.</p> <p>While low carrier frequency is the contrary. Low carrier frequency will cause unstable operation at low frequency, decrease the torque, or even lead to oscillation.</p> <p>The carrier frequency of VFD is set properly by default, and it should not be changed at will.</p> <p>If the default carrier frequency is exceeded during use, derating is required, derate by 10% for every additional 1k carrier frequency.</p> <p>Setting range: 1.0–15.0kHz</p>		
P00.15	Motor parameter autotuning	<p>0: No operation</p> <p>1: Complete rotary parameter autotuning</p> <p>2: Complete static parameter autotuning</p> <p>3: Partial static parameter autotuning</p> <p>4: Complete rotary parameter autotuning 2 (for asynchronous motors)</p> <p>5: Partial static parameter autotuning 2 (for asynchronous motors)</p>	0	☉
P00.16	AVR function	<p>0: Invalid</p> <p>1: Valid during the whole process</p> <p>Automatic voltage regulation function is used to eliminate the impact on the output voltage of VFD when bus voltage fluctuates.</p>	1	○
P00.18	Function parameter restoration	<p>0: No operation</p> <p>1: Restore default values (excluding motor parameters)</p> <p>2: Clear fault records</p> <p>3: Lock keypad parameters</p> <p>4: Reserved</p> <p>5: Restore default values (for factory test mode)</p> <p>6: Restore default values (including motor parameters)</p> <p><b>Note:</b> After the selected operation is done, this parameter is automatically restored to 0. Restoring the default values may delete the user password.</p> <p>Exercise caution when using this function. The option 5 can be used only for factory testing.</p>	0	☉

**P01 group—Start/stop control**

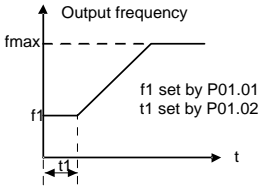
Function code	Name	Detailed parameter description	Default value	Modify
P01.00	Running mode of start	0: Direct start 1: Start after DC braking 2: Start after speed-tracking (with excitation)	0	☉
P01.01	Starting frequency of direct start	Starting frequency of direct startup is the initial frequency when the VFD starts. See P01.02 (hold time of starting frequency) for details. Setting range: 0.00–50.00Hz	0.50Hz	☉
P01.02	Hold time of starting frequency	 <p>A proper starting frequency can increase the torque during startup. Within the hold time of starting frequency, the output frequency of VFD is the starting frequency, and then it runs from the starting frequency to the target frequency, if the target frequency (frequency command) is below the starting frequency, the VFD will be standby rather than running. The starting frequency value is unlimited by the lower limit frequency. Setting range: 0.0–50.0s</p>	0.0s	☉
P01.03	DC braking current before start	During starting, the VFD will first perform DC braking based on the set DC braking current before startup, and then it will accelerate after the set DC braking time before startup elapses. If the set DC braking time is 0, DC braking will be invalid.	0.0%	☉
P01.04	DC braking time before start	The larger the DC braking current, the stronger the braking force. The DC braking current before startup refers to the percentage relative to rated VFD output current. Setting range of P01.03: 0.0–100.0% Setting range of P01.04: 0.00–50.00s	0.00s	☉
P01.05	Acceleration/deceleration mode	This function code is used to select the frequency variation mode during starting and running. 0: Straight line; the output frequency increases or	0	☉

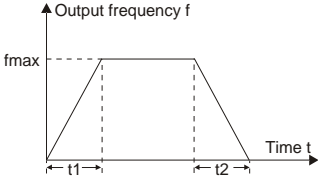
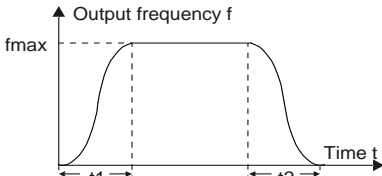
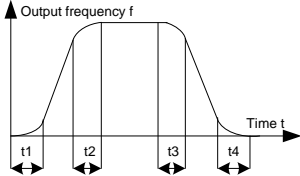
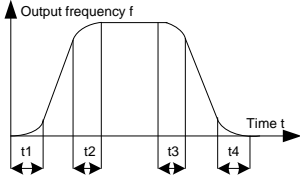
Function code	Name	Detailed parameter description	Default value	Modify
		<p>decreases in straight line;</p>  <p>1: S curve; the output frequency increases or decreases in S curve. S curve is generally used in cases where smooth start/stop is required, such as elevator, conveyer belt, and so on.</p>  <p><b>Note:</b> When set to 1, it is required to set P01.06, P01.07, P01.27 and P01.28 accordingly.</p>		
P01.06	Time of starting section of acceleration S curve	<p>The curvature of S curve is determined by acceleration range and acceleration and deceleration time.</p> 	0.1s	◎
P01.07	Time of ending section of acceleration S curve	 <p>t1=P01.06 t2=P01.07 t3=P01.27 t4=P01.28</p> <p>Setting range: 0.0–50.0s</p>	0.1s	◎
P01.08	Stop mode	<p>0: Decelerate to stop; after stop command is valid, the VFD lowers output frequency based on the deceleration mode and the defined deceleration time, after the frequency drops to the stop speed (P01.15), the VFD stops. 1: Coast to stop; after stop command is valid, the VFD stops output immediately, and the load coasts to stop as per mechanical inertia.</p>	0	○
P01.09	Starting	Starting frequency of DC braking after stop; during	0.00Hz	○

Function code	Name	Detailed parameter description	Default value	Modify
	frequency of DC braking after stop	decelerating to stop, when this frequency is reached, DC braking will be performed after stop.		
P01.10	Waiting time of DC braking after stop	Demagnetization time (waiting time of DC braking after stop): Before the DC braking, the VFD will block output, and after the demagnetization time elapses, DC braking will start. This function is used to prevent overcurrent fault caused by DC braking during high speed.	0.00s	○
P01.11	DC braking current of stop	DC braking current after stop: it means the DC braking force applied, the larger the current, the stronger the DC braking effect.	0.0%	○
P01.12	DC braking time of stop	<p>Setting range of P01.09: 0.00Hz–P00.03 (Max. output frequency)                      Setting range of P01.10: 0.00–30.00s                      Setting range of P01.11: 0.0–100.0% (of the rated VFD output current)                      Setting range of P01.12: 0.00–50.00s</p>	0.00s	○
P01.13	Deadzone time of forward/reverse rotation	<p>This function code refers to the transition time of the threshold set by P01.14 during setting forward/reverse rotation of the VFD, as shown below.</p> <p>Setting range: 0.0–3600.0s</p>	0.0s	○
P01.14	Forward/reverse rotation switchover mode	0: Switch over after zero frequency 1: Switch over after starting frequency 2: Switch over after passing stop speed and delay	1	◎
P01.15	Stop speed	0.00–100.00Hz	0.50Hz	◎

Function code	Name	Detailed parameter description	Default value	Modify
P01.16	Stop speed detection mode	0: Set value of speed (the only detection mode valid in V/F mode) 1: Detection value of speed	0	☉
P01.17	Stop speed detection time	0.00–100.00s	0.50s	☉
P01.18	Running protection of power-on terminal	When the running command channel is controlled by terminals, the system will detect running terminal state automatically during power up. 0: Terminal running command is invalid during power up. The VFD will not run during power up even if the running command terminal is detected to be valid, and the system is in running protection state. The VFD will run only after this terminal is cancelled and enabled again. Note that the value takes effect only when P01.21 is also set to 0. 1: Terminal running command is valid during power up. The system will start the VFD automatically after initialization is done if the running command terminal is detected to be valid during power up. <b>Note:</b> This function must be set with caution; otherwise, serious consequences may occur.	0	○
P01.19	Action selected when running frequency less than frequency lower limit (valid when frequency lower limit greater than 0)	0x00–0x12 This parameter specifies the running status of VFD when the set frequency is below the lower limit. Ones place: Action selection 0: Run in lower limit of the frequency 1: Stop 2: Sleep Tens place: Stop mode 0: Coast to stop 1: Decelerate to stop The VFD stops as set in the tens place if the action selection is stop or sleep when the set frequency is below the lower limit. The VFD resumes the running state automatically when the set frequency is above the lower limit again and this situation lasts for the time set by P01.20. Setting range: 0x00–0x12	0x00	☉
P01.20	Wake-up-from-	This function code is used to set the sleep delay.	0.0s	○

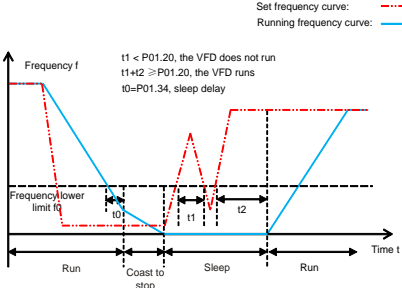
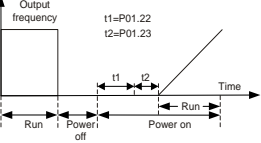
Function code	Name	Detailed parameter description	Default value	Modify
	sleep delay	<p>When the running frequency of VFD is below the lower limit frequency, the VFD enters sleep state; when the set frequency is above the lower limit again and continues to be so after the time set by P01.20 elapses, the VFD will run automatically.</p>  <p>Setting range: 0.0–3600.0s (valid when the ones place of P01.19 is 2)</p>		
P01.21	Restart after power down	<p>This function code sets the automatic running of the VFD at next power-on after power down.</p> <p>0: Disable restart 1: Enable restart, namely the VFD will run automatically after the time set by P01.22 elapses if the starting conditions are met.</p>	0	○
P01.22	Waiting time of restart after power down	<p>This function code sets the waiting time before automatically running at next power-on after power down.</p>  <p>Setting range: 0.0–3600.0s (valid when P01.21= 1)</p>	1.0s	○
P01.23	Start delay	<p>This function code sets the delay of the VFD's wake-up-from-sleep after running command is given, the VFD will start to run and output after the time set by P01.23 elapses to realize brake release.</p> <p>Setting range: 0.0–600.0s</p>	0.0s	○
P01.24	Stop speed delay	0.0–600.0s	0.0s	○

Function code	Name	Detailed parameter description	Default value	Modify
P01.25	Open-loop 0Hz output selection	0: No voltage output 1: With voltage output 2: Output as per DC braking current of stop	0	○
P01.26	Deceleration time of emergency-stop	0.0–60.0s	2.0s	○
P01.27	Time of starting section of deceleration S curve	0.0–50.0s	0.1s	◎
P01.28	Time of ending section of deceleration S curve	0.0–50.0s	0.1s	◎
P01.29	Short-circuit braking current	When the VFD starts in direct start mode (P01.00=0), set P01.30 to a non-zero value to enter short-circuit braking. During stop, if the running frequency of VFD is below the starting frequency of braking after stop, set P01.31 to a non-zero value to enter short-circuit braking after stop, and then carry out DC braking in the time set by P01.12 (refer to P01.09–P01.12). Setting range of P01.29: 0.0–150.0% (of the rated VFD output current) Setting range of P01.30 and P01.31: 0.00–50.00s	0.0%	○
P01.30	Hold time of short-circuit braking at startup		0.00s	○
P01.31	Hold time of short-circuit braking at stop		0.00s	○
P01.32	Pre-exciting time of jogging	0–10.000s	0.300s	○
P01.33	Starting frequency of braking for jogging to stop	0.00Hz–P00.03	0.00Hz	○
P01.34	Delay to enter sleep	0.0–3600.0s	0.0s	○

**P02 group—Parameters of motor 1**

Function code	Name	Detailed parameter description	Default value	Modify
P02.00	Type of motor 1	0: Asynchronous motor	0	◎

Function code	Name	Detailed parameter description	Default value	Modify
		1: Synchronous motor		
P02.01	Rated power of asynchronous motor 1	0.1–3000.0kW	Depends on model	<input checked="" type="radio"/>
P02.02	Rated frequency of asynchronous motor 1	0.01Hz–P00.03 (Max. output frequency)	60.00Hz	<input checked="" type="radio"/>
P02.03	Rated speed of asynchronous motor 1	1–60000rpm	1700rpm	<input checked="" type="radio"/>
P02.04	Rated voltage of asynchronous motor 1	0–1200V	Depends on model	<input checked="" type="radio"/>
P02.05	Rated current of asynchronous motor 1	0.8–6000.0A	Depends on model	<input checked="" type="radio"/>
P02.06	Stator resistance of asynchronous motor 1	0.001–65.535Ω	Depends on model	<input type="radio"/>
P02.07	Rotor resistance of asynchronous motor 1	0.001–65.535Ω	Depends on model	<input type="radio"/>
P02.08	Leakage inductance of asynchronous motor 1	0.1–6553.5mH	Depends on model	<input type="radio"/>
P02.09	Mutual inductance of asynchronous motor 1	0.1–6553.5mH	Depends on model	<input type="radio"/>
P02.10	No-load current of asynchronous motor 1	0.1–6553.5A	Depends on model	<input type="radio"/>
P02.11	Magnetic saturation coefficient 1 of iron core of asynchronous	0.0–100.0%	80.0%	<input type="radio"/>



Function code	Name	Detailed parameter description	Default value	Modify
	motor 1			
P02.12	Magnetic saturation coefficient 2 of iron core of asynchronous motor 1	0.0–100.0%	68.0%	<input type="radio"/>
P02.13	Magnetic saturation coefficient 3 of iron core of asynchronous motor 1	0.0–100.0%	57.0%	<input type="radio"/>
P02.14	Magnetic saturation coefficient 4 of iron core of asynchronous motor 1	0.0–100.0%	40.0%	<input type="radio"/>
P02.15	Rated power of synchronous motor 1	0.1–3000.0kW	Depends on model	<input checked="" type="radio"/>
P02.16	Rated frequency of synchronous motor 1	0.01Hz–P00.03 (Max. output frequency)	60.00Hz	<input checked="" type="radio"/>
P02.17	Number of pole pairs of synchronous motor 1	1–128	2	<input checked="" type="radio"/>
P02.18	Rated voltage of synchronous motor 1	0–1200V	Depends on model	<input checked="" type="radio"/>
P02.19	Rated current of synchronous motor 1	0.8–6000.0A	Depends on model	<input checked="" type="radio"/>
P02.20	Stator resistance of synchronous motor 1	0.001–65.535Ω	Depends on model	<input type="radio"/>

Function code	Name	Detailed parameter description	Default value	Modify
P02.21	Direct-axis inductance of synchronous motor 1	0.01–655.35mH	Depends on model	<input type="radio"/>
P02.22	Quadrature-axis inductance of synchronous motor 1	0.01–655.35mH	Depends on model	<input type="radio"/>
P02.23	Counter-emf constant of synchronous motor 1	0–10000	300	<input type="radio"/>
P02.24	Initial pole position of synchronous motor 1	0x0000–0xFFFF	0x0000	<input checked="" type="radio"/>
P02.25	Identification current of synchronous motor 1	0%–50% (of motor rated current)	10%	<input checked="" type="radio"/>
P02.26	Overload protection of motor 1	<p>0: No protection</p> <p>1: Common motor (with low-speed compensation). As the cooling effect of common motor will be degraded in low speed, the corresponding electronic thermal protection value should also be adjusted properly, the low compensation here means to lower the overload protection threshold of the motor whose running frequency is below 30Hz.</p> <p>2: Frequency-variable motor (without low-speed compensation). As the cooling effect of frequency-variable motor is not affected by the rotating speed, there is no need to adjust the protection value during low-speed running.</p>	2	<input checked="" type="radio"/>
P02.27	Overload protection coefficient of motor 1	<p>Motor overload multiples <math>M = I_{out} / (I_n \times K)</math></p> <p><math>I_n</math> is rated motor current, <math>I_{out}</math> is VFD output current, <math>K</math> is motor overload protection coefficient.</p> <p>The smaller the <math>K</math>, the larger the value of <math>M</math>, and the easier the protection.</p>	100.0%	<input type="radio"/>

Function code	Name	Detailed parameter description	Default value	Modify
		<p>When M=116%, protection is performed after motor overload lasts for 1 hour; when M=150%, protection is performed after motor overload lasts for 12 minutes; when M=180%, protection is performed after motor overload lasts for 5 minutes; when M=200%, protection is performed after motor overload lasts for 60 seconds; and when M≥ 400%, protection is performed immediately.</p> <p>Setting range: 20.0%–150.0%</p>		
P02.28	Power display calibration coefficient of motor 1	<p>This function adjusts the power display value of motor 1 only, and it does not affect the control performance of the VFD.</p> <p>Setting range: 0.00–3.00</p>	1.00	<input type="radio"/>
P02.29	Parameter display of motor 1	<p>0: Display as per motor type; under this mode, only parameters related to current motor type will be displayed.</p> <p>1: Display all; under this mode, all the motor parameters will be displayed.</p>	0	<input type="radio"/>
P02.30	System inertia of motor 1	0.000–30.000kgm <sup>2</sup>	0.000 kgm <sup>2</sup>	<input type="radio"/>
P02.31–P02.32	Reserved			

**P03 group—Vector control of motor 1**

Function code	Name	Detailed parameter description	Default value	Modify
P03.00	Speed loop proportional gain 1	Parameters of P03.00–P03.05 fit for vector control mode only. Below P03.02, speed loop PI parameter is P03.00 and P03.01; above P03.06, speed loop PI parameter is P03.03 and P03.04; in	20.0	<input type="radio"/>
P03.01	Speed loop integral time 1		0.200s	<input type="radio"/>

Function code	Name	Detailed parameter description	Default value	Modify
P03.02	Switch low point frequency	<p>between, PI parameter is obtained by linear variation between two groups of parameters, as shown below.</p>	5.00Hz	<input type="radio"/>
P03.03	Speed loop proportional gain 2		20.0	<input type="radio"/>
P03.04	Speed loop integral time 2		0.200s	<input type="radio"/>
P03.05	Switch over high point frequency		<p>The speed loop dynamic response characteristics of vector control can be adjusted by setting the proportional coefficient and integral time of speed regulator. Increase proportional gain or decrease integral time can accelerate dynamic response of speed loop, however, if the proportional gain is too large or integral time is too small, system oscillation and overshoot may occur; if proportional gain is too small, stable oscillation or speed offset may occur.</p> <p>Speed loop PI parameter is closely related to the system inertial, you should make adjustment based on default PI parameter according to different load characteristics to fulfill different needs.</p> <p>Setting range of P03.00:0.0–200.0                      Setting range of P03.01: 0.000–10.000s                      Setting range of P03.02: 0.00Hz–P03.05                      Setting range of P03.03: 0.0–200.0                      Setting range of P03.04: 0.000–10.000s                      Setting range of P03.05: P03.02–P00.03 (Max. output frequency)</p>	10.00Hz
P03.06	Speed loop output filter	0–8 (corresponds to 0–2 <sup>8</sup> /10ms)	0	<input type="radio"/>
P03.07	Vector control slip compensation coefficient	Slip compensation coefficient is used to adjust the slip frequency of vector control to improve speed control precision. This parameter can be used to	100%	<input type="radio"/>

Function code	Name	Detailed parameter description	Default value	Modify
	(motoring)	control speed offset.		
P03.08	Vector control slip compensation coefficient (generating)	Setting range: 50–200%	100%	<input type="radio"/>
P03.09	Current loop proportional coefficient P	<b>Note:</b> 1. These two parameters are used to adjust PI parameters of current loop; it affects dynamic response speed and control precision of the system directly. The default value needs no adjustment under common conditions; 2. Applicable to SVC mode 0 (P00.00=0), SVC mode 1 (P00.00=1), and FVC (P00.00=3) Setting range: 0–65535	1000	<input type="radio"/>
P03.10	Current loop integral coefficient I		1000	<input type="radio"/>
P03.11	Torque setting mode selection	0–1: Keypad (P03.12) 2: AI1 3: AI2 4: AI3 5: Pulse frequency HDIA 6: Multi-step torque 7: Modbus/Modbus TCP communication 8: CANopen communication 9: Ethernet communication 10: Pulse frequency HDIB 11: EtherCAT/PROFINET/EtherNet IP 12: Programmable card <b>Note:</b> For these settings, 100% corresponds to the motor rated current.	0	<input type="radio"/>
P03.12	Torque set by keypad	-300.0%–300.0% (of the motor rated current)	20.0%	<input type="radio"/>
P03.13	Torque reference filter time	0.000–10.000s	0.010s	<input type="radio"/>
P03.14	Setting source of FWD rotation frequency upper limit in torque control	0: Keypad (P03.16) 1: AI1 2: AI2 3: AI3 4: Pulse frequency HDIA 5: Multi-step setting	0	<input type="radio"/>

Function code	Name	Detailed parameter description	Default value	Modify
		6: Modbus/Modbus TCP communication 7: CANopen communication 8: Ethernet communication 9: Pulse frequency HDIB 10: EtherCAT/PROFINET/EtherNet IP communication 11: Programmable card 12: Reserved <b>Note:</b> For these settings, 100% corresponds to the max. frequency.		
P03.15	Setting source of REV rotation frequency upper limit in torque control	0: Keypad (P03.17) 1: AI1 2: AI2 3: AI3 4: Pulse frequency HDIA 5: Multi-step setting 6: Modbus/Modbus TCP communication 7: CANopen communication 8: Ethernet communication 9: Pulse frequency HDIB 10: EtherCAT/PROFINET/EtherNet IP communication 11: Programmable card 12: Reserved <b>Note:</b> For these settings, 100% corresponds to the max. frequency.	0	○
P03.16	FWD rotation frequency upper limit set through keypad in torque control	Used to specify frequency limits. 100% corresponds to the max. frequency. P03.16 specifies the upper-limit frequency when P03.14=1; P03.17 specifies the upper-limit frequency when P03.15=1. Setting range: 0.00Hz–P00.03 (Max. output frequency)	60.00Hz	○
P03.17	REV rotation frequency upper limit set through keypad in torque control		60.00Hz	○
P03.18	Setting source of electromotive torque upper limit	0: Keypad (P03.20) 1: AI1 2: AI2	0	○

Function code	Name	Detailed parameter description	Default value	Modify
		3: AI3 4: Pulse frequency HDIA 5: Modbus/Modbus TCP communication 6: CANopen communication 7: Ethernet communication 8: Pulse frequency HDIB 9: EtherCAT/PROFINET/EtherNet IP communication 10: Programmable card 11: Reserved <b>Note:</b> For these settings, 100% corresponds to the motor rated current.		
P03.19	Setting source of braking torque upper limit	0: Keypad (P03.21) 1: AI1 2: AI2 3: AI3 4: Pulse frequency HDIA 5: Modbus/Modbus TCP communication 6: CANopen communication 7: Ethernet communication 8: Pulse frequency HDIB 9: EtherCAT/PROFINET/EtherNet IP communication 10: Programmable card 11: Reserved <b>Note:</b> For these settings, 100% corresponds to the motor rated current.	0	<input type="radio"/>
P03.20	Electromotive torque upper limit set through keypad	Used to set torque limits. Setting range: 0.0–300.0% (of the motor rated current)	180.0%	<input type="radio"/>
P03.21	Braking torque upper limit set through keypad		180.0%	<input type="radio"/>
P03.22	Flux-weakening coefficient of constant-power zone	Used when asynchronous motor is in flux-weakening control.	0.3	<input type="radio"/>
P03.23	Min. flux-		20%	<input type="radio"/>

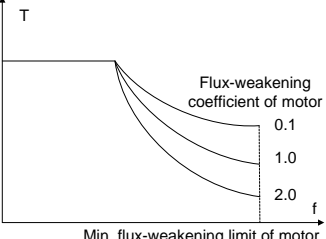
Function code	Name	Detailed parameter description	Default value	Modify
	weakening point of constant-power zone	 <p>P03.22 and P03.23 are valid during constant power. When motor speed is above rated speed, motor enters flux-weakening running state. The flux-weakening control coefficient can change the flux-weakening curvature, the larger the coefficient, the steeper the curve, the smaller the coefficient, the smoother the curve.                      Setting range of P03.22: 0.1–2.0                      Setting range of P03.23: 10%–100%</p>		
P03.24	Max. voltage limit	P03.24 sets the maximum output voltage of the VFD, which is the percentage of rated motor voltage. This value should be set according to field conditions. Setting range:0.0–120.0%	100.0%	<input type="radio"/>
P03.25	Pre-exciting time	Carry out motor pre-exciting during starting to build a magnetic field inside the motor to improve the torque characteristics of motor during starting. Setting range: 0.000–10.000s	0.300s	<input type="radio"/>
P03.26	Flux-weakening proportional gain	0–8000	1000	<input type="radio"/>
P03.27	Vector control speed display	0: Display as per the actual value 1: Display as per the set value	0	<input type="radio"/>
P03.28	Static friction compensation coefficient	0.0–100.0%	0.0%	<input type="radio"/>
P03.29	Corresponding frequency point of static friction	0.50–P03.31	1.00Hz	<input type="radio"/>
P03.30	High speed friction compensation	0.0–100.0%	0.0%	<input type="radio"/>



Function code	Name	Detailed parameter description	Default value	Modify
	coefficient			
P03.31	Corresponding frequency of high-speed friction torque	P03.29–599.00Hz	50.00Hz	<input type="radio"/>
P03.32	Enabling torque control	0: Disable 1: Enable	0	<input checked="" type="radio"/>
P03.33	Flux weakening integral gain	0–8000	1200	<input type="radio"/>
P03.34	Flux-weakening control mode	0x000–0x112 Ones place: Control mode 0: Mode 0 1: Mode 1 2: Mode 2 Tens place: Compensation of inductance saturation coefficient 0: Enable 1: Disable Hundreds place: Reserved 0: Reserved 1: Reserved	0x000	<input type="radio"/>
P03.35	Control optimization setting	0x0000–0x1111 Ones place: Torque command selection 0: Torque reference 1: Torque current reference Tens place: Reserved 0: Reserved 1: Reserved Hundreds place: Whether to enable ASR integral separation 0: Disable 1: Enable Thousands place: Reserved 0: Reserved 1: Reserved	0x0000	<input type="radio"/>
P03.36	Speed loop differential gain	0.00–10.00s	0.00s	<input type="radio"/>
P03.37	High-frequency	In FVC (P00.00=3), when the frequency is lower	1000	<input type="radio"/>

Function code	Name	Detailed parameter description	Default value	Modify
	current loop proportional coefficient	than the ACR high-frequency switching threshold (P03.39), the ACR PI parameters are P03.09 and P03.10; and when the frequency is higher than the		
P03.38	High-frequency current loop integral coefficient	ACR high-frequency switching threshold (P03.39), the ACR PI parameters are P03.37 and P03.38. Setting range of P03.37: 0–65535 Setting range of P03.38: 0–65535	1000	<input type="radio"/>
P03.39	Current loop high-frequency switchover point	Setting range of P03.39: 0.0–100.0% (relative to max. frequency)	100.0%	<input type="radio"/>
P03.40	Enabling inertia compensation	0: Disable 1: Enable	0	<input type="radio"/>
P03.41	Upper limit of inertia compensation torque	Limit the max. inertia compensation torque to prevent inertia compensation torque from being too large. Setting range: 0.0–150.0% (rated motor torque)	10.0%	<input type="radio"/>
P03.42	Inertia compensation filter times	Filter times of inertia compensation torque, used to smooth inertia compensation torque. Setting range: 0–10	7	<input type="radio"/>
P03.43	Inertia identification torque value	Due to friction force, it is required to set certain identification torque for the inertia identification to be performed properly. 0.0–100.0% (rated motor torque)	10.0%	<input type="radio"/>
P03.44	Enable inertia identification	0: No operation 1: Start identification	0	<input checked="" type="radio"/>
P03.45	Current loop proportional coefficient after autotuning	Automatic update will be performed after motor parameter autotuning. In the closed-loop vector control mode for synchronous motors, you can set the value of this function code to P03.09. Range: 0–65535 <b>Note:</b> Set the value to 0 if motor parameter autotuning is not performed.	0	<input checked="" type="radio"/>
P03.46	Current integral proportional coefficient after autotuning	Automatic update will be performed after motor parameter autotuning. In the closed-loop vector control mode for synchronous motors, you can set the value of this function code to P03.10. Range: 0–65535 <b>Note:</b> Set the value to 0 if motor parameter autotuning is not performed.	0	<input checked="" type="radio"/>

Function code	Name	Detailed parameter description	Default value	Modify
P03.47	SVC1 optimized mode for asynchronous motors	0–2 0: Common mode 1: Optimized mode 1 (reserved) 2: Optimized mode 2	0	☉
P03.48	SVC1 speed filter coefficient	0–200	50	○
P03.49	Current loop proportional coefficient	0–5000	1000	○
P03.50	Regulation function in optimized mode	0x0000–0x2114 Ones place: Pre-excitation selection 0: Pre-excitation is invalid 1: Perform automatic pre-excitation by rotator time constant 2: Perform automatic pre-excitation loop-closing by rotator time constant 3: Perform pre-excitation for the time specified by P03.25 4: Perform pre-excitation loop-closing for the time specified by P03.25 Tens place: Speed loop proportional integral separation selection 0: No separation 1: Separation Hundreds place: Min. frequency limit at stalling in torque mode 0: Limit is valid 1: No limit Thousands place: Speed loop output max. limit value (reserved) 0–2: Reserved	0x0011	☉
P03.51–P03.52	Reserved			
P03.53	Zero drift handling	0–0 0: Perform zero drift detection at stop	0	○
P03.54	Enabling energy-saving control in SVC1 for asynchronous	0–1 0: Disable 1: Enable	0	○

Function code	Name	Detailed parameter description	Default value	Modify
	motors			
P03.55	Min. limit value for energy-saving control in vector control	0.0–100.0%	40.0%	<input type="radio"/>
P03.56	Gain coefficient for energy-saving control in vector control	0.0–400.0%	100.0%	<input type="radio"/>

**P04 group—V/F control**

Function code	Name	Detailed parameter description	Default value	Modify
P04.00	V/F curve setting of motor 1	<p>This function code defines the V/F curve of motor 1 to satisfy different load characteristics needs.</p> <p>0: Straight V/F curve; fit for constant-torque load                      1: Multi-point V/F curve                      2: Torque down V/F curve (power of 1.3)                      3: Torque down V/F curve (power of 1.7)                      4: Torque down V/F curve (power of 2.0)</p> <p>Curves 2–4 are suitable for torque-variable load of fan pump and similar equipment. You can make adjustment based on load characteristics to achieve optimal energy-saving effect.</p> <p>5: Customized V/F (V/F separation); under this mode, V is separated from f. You can adjust f through the frequency reference channel set by P00.06 to change the curve characteristic, or adjust V through the voltage reference channel set by P04.27 to change the curve characteristics.</p> <p><b>Note:</b> The <math>V_b</math> in the figure below corresponds to rated motor voltage, and <math>f_b</math> corresponds to rated motor frequency.</p>	0	<input checked="" type="radio"/>
P04.01	Torque boost of	In order to compensate for low-frequency torque	0.0%	<input type="radio"/>

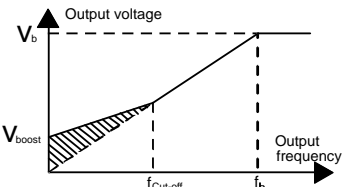
Function code	Name	Detailed parameter description	Default value	Modify
	motor 1	characteristics, you can make some boost compensation to the output voltage. P04.01 is relative to the maximum output voltage $V_b$ . P04.02 defines the percentage of cut-off frequency of manual torque boost to the rated motor frequency $f_b$ . Torque boost can improve the low-frequency torque characteristics of V/F. You should select torque boost based on the load, For example, larger load requires larger torque boost, however, if the torque boost is too large, the motor will run at over-excitation, which will cause increased output current and motor heat-up, thus degrading the efficiency.		
P04.02	Motor 1 torque boost cut-off	<p>When torque boost is set to 0.0%, the VFD is automatic torque boost.</p> <p>Torque boost cut-off threshold: Below this frequency threshold, the torque boost is valid, exceeding this threshold will nullify torque boost.</p>  <p>Setting range of P04.01: 0.0%: (automatic); 0.1%–10.0%</p> <p>Setting range of P04.02: 0.0%–50.0%</p>	20.0%	<input type="radio"/>
P04.03	V/F frequency point 1 of motor 1	<p>When P04.00 =1 (multi-point V/F curve), you can set V/F curve via P04.03–P04.08.</p> <p>V/F curve is usually set according to the characteristics of motor load.</p> <p><b>Note:</b> <math>V1 &lt; V2 &lt; V3</math>, <math>f1 &lt; f2 &lt; f3</math>. If low-frequency voltage is set too high, motor overheat or burnt-down may occur, and overcurrent stall or overcurrent protection may occur to the VFD.</p>	0.00Hz	<input type="radio"/>
P04.04	V/F voltage point 1 of motor 1		00.0%	<input type="radio"/>
P04.05	V/F frequency point 2 of motor 1		0.00Hz	<input type="radio"/>
P04.06	V/F voltage point 2 of motor 1		0.0%	<input type="radio"/>
P04.07	V/F frequency point 3 of motor 1		0.00Hz	<input type="radio"/>
P04.08	V/F voltage point		00.0%	<input type="radio"/>

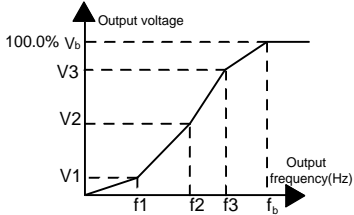
Function code	Name	Detailed parameter description	Default value	Modify
	3 of motor 1	 <p>Setting range of P04.03: 0.00Hz–P04.05                      Setting range of P04.04: 0.0%–110.0% (rated voltage of motor 1)                      Setting range of P04.05: P04.03–P04.07                      Setting range of P04.06: 0.0%–110.0% (rated voltage of motor 1)                      Setting range of P04.07: P04.05–P02.02 (rated frequency of asynchronous motor 1) or P04.05–P02.16 (rated frequency of synchronous motor 1)                      Setting range of P04.08: 0.0%–110.0% (rated voltage of motor 1)</p>		
P04.09	V/F slip compensation gain of motor 1	<p>This parameter is used to compensate for the motor rotating speed change caused by load change in the SVPWM mode, and thus improve the rigidity of the mechanical characteristics of the motor. You need to calculate the rated slip frequency of the motor as follows:  <math>\Delta f = f_b - n \times p / 60</math>                      where <math>f_b</math> is the rated frequency of motor 1, corresponding to P02.02; <math>n</math> is the rated speed of motor 1, corresponding to P02.03; <math>p</math> is the number of pole pairs of motor 1. 100% corresponds to the rated slip frequency <math>\Delta f</math> of motor 1.                      Setting range: 0.0–200.0%</p>	100.0%	○
P04.10	Low-frequency oscillation control factor of motor 1	<p>In SVPWM mode, the motor, especially the large-power motor may experience current oscillation during certain frequencies, which may lead to unstable motor operation, or even VFD overcurrent, you can adjust these two parameters properly to eliminate such phenomenon.</p> <p>Setting range of P04.10: 0–100                      Setting range of P04.11: 0–100</p>	10	○
P04.11	High-frequency oscillation control factor of motor 1		10	○
P04.12	Oscillation control threshold of		30.00Hz	○

Function code	Name	Detailed parameter description	Default value	Modify
	motor 1	Setting range of P04.12: 0.00Hz–P00.03 (Max. output frequency)		
P04.13	V/F curve setting of motor 2	This parameter defines the V/F curve of motor 2 of the UMI-B7 series to meet various load characteristic requirements. 0: Straight V/F curve 1: Multi-point V/F curve 2: Torque-down V/F curve (power of 1.3) 3: Torque-down V/F curve (power of 1.7) 4: Torque-down V/F curve (power of 2.0) 5: Customize V/F (V/F separation)	0	☉
P04.14	Torque boost of motor 2	<b>Note:</b> Refer to the parameter description of P04.01 and P04.02.	0.0%	○
P04.15	Torque boost cut-off of motor 2	Setting range of P04.14: 0.0%: (automatic); 0.1%–10.0% Setting range of 0.0%–50.0% (relative to rated frequency of motor 2)	20.0%	○
P04.16	V/F frequency point 1 of motor 2	<b>Note:</b> Refer to the parameter description of P04.03–P04.08	0.00Hz	○
P04.17	V/F voltage point 1 of motor 2	Setting range of P04.16: 0.00Hz–P04.18 Setting range of P04.17:0.0%–110.0% (rated voltage of motor 2)	00.0%	○
P04.18	V/F frequency point 2 of motor 2	Setting range of P04.18: P04.16–P04.20	0.00Hz	○
P04.19	V/F voltage point 2 of motor 2	Setting range of P04.19: 0.0%–110.0% (rated voltage of motor 2)	00.0%	○
P04.20	V/F frequency point 3 of motor 2	Setting range of P04.20: P04.18–P12.02 (rated frequency of asynchronous motor 2) or P04.18–P12.16 (rated frequency of synchronous motor 2)	0.00Hz	○
P04.21	V/F voltage point 3 of motor 2	Setting range of P04.21:0.0%–110.0% (of the rated voltage of motor 2)	00.0%	○
P04.22	V/F slip compensation gain of motor 2	This parameter is used to compensate for the motor rotating speed change caused by load change in the SVPWM mode, and thus improve the rigidity of the mechanical characteristics of the motor. You need to calculate the rated slip frequency of the motor as follows: $\Delta f = f_b \cdot n \cdot p / 60$ where $f_b$ is the rated frequency of motor 2,	0.0%	○

Function code	Name	Detailed parameter description	Default value	Modify
		corresponding to P12.02; n is the rated speed of motor 2, corresponding to P12.03; p is the number of pole pairs of motor 2. 100% corresponds to the rated slip frequency $\Delta f$ of motor 2. Setting range: 0.0–200.0%		
P04.23	Low-frequency oscillation control factor of motor 2	In the SVPWM mode, current oscillation may easily occur on motors, especially large-power motors, at some frequency, which may cause unstable running of motors or even overcurrent of VFDs. You can modify this parameter to prevent current oscillation. Setting range of P04.23: 0–100 Setting range of P04.24: 0–100 Setting range of P04.25: 0.00 Hz–P00.03 (Max. output frequency)	10	<input type="radio"/>
P04.24	High-frequency oscillation control factor of motor 2		10	<input type="radio"/>
P04.25	Oscillation control threshold of motor 2		30.00Hz	<input type="radio"/>
P04.26	Energy-saving run	0: No action 1: Automatic energy-saving operation Under light-load state, the motor can adjust the output voltage automatically to achieve energy-saving purpose	0	<input checked="" type="radio"/>
P04.27	Voltage setting channel	0: Keypad; output voltage is determined by P04.28 1: AI1 2: AI2 3: AI3 4: HDIA 5: Multi-step (the set value is determined by P10 group) 6: PID 7: Modbus/Modbus TCP communication 8: CANopen communication 9: Ethernet communication 10: HDIB 11: EtherCAT/PROFINET/EtherNet IP 12: Programmable card 13: Reserved	0	<input type="radio"/>
P04.28	Voltage value set through keypad	When the keypad is set as the voltage setting channel, the value of this parameter is used as the voltage value. Setting range: 0.0%–100.0%	100.0%	<input type="radio"/>

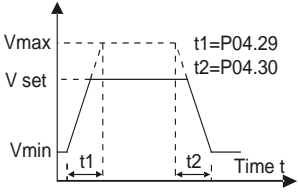

Function code	Name	Detailed parameter description	Default value	Modify
P04.29	Voltage increase time	Voltage increase time means the time needed from outputting the min. voltage to accelerating to output the max. voltage. Voltage decrease time means the time needed from outputting max. voltage to outputting the min. voltage Setting range: 0.0–3600.0s	5.0s	<input type="radio"/>
P04.30	Voltage decrease time		5.0s	<input type="radio"/>
P04.31	Output max. voltage	Set the upper/lower limit value of output voltage.	100.0%	<input checked="" type="radio"/>
P04.32	Output min. voltage	 <p>Setting range of P04.31: P04.32–100.0% (rated motor voltage) Setting range of P04.32: 0.0%–P04.31</p>	0.0%	<input checked="" type="radio"/>
P04.33	Flux-weakening coefficient in the constant power zone	1.00–1.30	1.00	<input type="radio"/>
P04.34	Pull-in current 1 in synchronous motor VF control	When the synchronous motor VF control mode is enabled, this parameter is used to set the reactive current of the motor when the output frequency is lower than the frequency set in P04.36. Setting range: -100.0%→+100.0% (of the rated current of the motor)	20.0%	<input type="radio"/>
P04.35	Pull-in current 2 in synchronous motor VF control	When the synchronous motor VF control mode is enabled, this parameter is used to set the reactive current of the motor when the output frequency is higher than the frequency set in P04.36. Setting range: -100.0%→+100.0% (of the rated current of the motor)	10.0%	<input type="radio"/>
P04.36	Frequency threshold for input current switching in synchronous motor VF control	When the synchronous motor VF control mode is enabled, this parameter is used to set the frequency threshold for the switching between input current 1 and input current 2. Setting range: 0.0%–200.0% (of the motor rated frequency)	20.0%	<input type="radio"/>

Function code	Name	Detailed parameter description	Default value	Modify
P04.37	Reactive current closed-loop proportional coefficient in synchronous motor VF	When the synchronous motor VF control mode is enabled, this parameter is used to set the proportional coefficient of the reactive current closed-loop control. Setting range: 0–3000	50	<input type="radio"/>
P04.38	Reactive current closed-loop integral time in synchronous motor VF control	When the synchronous motor VF control mode is enabled, this parameter is used to set the integral coefficient of the reactive current closed-loop control. Setting range: 0–3000	30	<input type="radio"/>
P04.39	Reactive current closed-loop output limit in synchronous motor VF control	When the synchronous motor VF control mode is enabled, this parameter is used to set the output limit of the reactive current in the closed-loop control. A greater value indicates a higher reactive closed-loop compensation voltage and higher output power of the motor. In general, you do not need to modify this parameter. Setting range: 0–16000	8000	<input type="radio"/>
P04.40	Enable/disable IF mode for asynchronous motor 1	0: Disable 1: Enable	0	<input checked="" type="radio"/>
P04.41	Current setting in IF mode for asynchronous motor 1	When IF control is adopted for asynchronous motor 1, this parameter is used to set the output current. The value is a percentage in relative to the rated current of the motor. Setting range: 0.0–200.0%	120.0%	<input type="radio"/>
P04.42	Proportional coefficient in IF mode for asynchronous motor 1	When IF control is adopted for asynchronous motor 1, this parameter is used to set the proportional coefficient of the output current closed-loop control. Setting range: 0–5000	350	<input type="radio"/>
P04.43	Integral coefficient in IF mode for asynchronous motor 1	When IF control is adopted for asynchronous motor 1, this parameter is used to set the integral coefficient of the output current closed-loop control. Setting range: 0–5000	150	<input type="radio"/>

Function code	Name	Detailed parameter description	Default value	Modify
P04.44	Starting frequency point for switching off IF mode for asynchronous motor 1	When IF control is adopted for asynchronous motor 1, this parameter is used to set the frequency threshold for switching off the output current closed-loop control. When the frequency is lower than the value of this parameter, the current closed-loop control in the IF control mode is enabled; and when the frequency is higher than that, the current closed-loop control in the IF control mode is disabled. Setting range: 0.00–P04.50	10.00Hz	<input type="radio"/>
P04.45	Enable/disable IF mode for asynchronous motor 2	0: Disable 1: Enable	0	<input checked="" type="radio"/>
P04.46	Current setting in IF mode for asynchronous motor 2	When IF control is adopted for asynchronous motor 2, this parameter is used to set the output current. The value is a percentage in relative to the rated current of the motor. Setting range: 0.0–200.0%	120.0%	<input type="radio"/>
P04.47	Proportional coefficient in IF mode for asynchronous motor 2	When IF control is adopted for asynchronous motor 2, this parameter is used to set the proportional coefficient of the output current closed-loop control. Setting range: 0–5000	350	<input type="radio"/>
P04.48	Integral coefficient in IF mode for asynchronous motor 2	When IF control is adopted for asynchronous motor 2, this parameter is used to set the integral coefficient of the output current closed-loop control. Setting range: 0–5000	150	<input type="radio"/>
P04.49	Starting frequency point for switching off IF mode for asynchronous motor 2	When IF control is adopted for asynchronous motor 2, this parameter is used to set the frequency threshold for switching off the output current closed-loop control. When the frequency is lower than the value of this parameter, the current closed-loop control in the IF control mode is enabled; and when the frequency is higher than that, the current closed-loop control in the IF control mode is disabled. Setting range: 0.00–P04.51	10.00Hz	<input type="radio"/>

Function code	Name	Detailed parameter description	Default value	Modify
P04.50	End frequency point for switching off IF mode for asynchronous motor 1	P04.44–P00.03	25.00Hz	○
P04.51	End frequency point for switching off IF mode for asynchronous motor 2	P04.49–P00.03	25.00Hz	○
P04.52	V/F energy-saving mode selection	0–2 0: Max. efficiency (default) 1: Optimal power factor 2: MTPA	0	○
P04.53	V/F energy-saving gain coefficient	0.0–400.0%	100.0%	○

**P05 group—Input terminals**

Function code	Name	Detailed parameter description	Default value	Modify
P05.00	HDI input type	0x00–0x11 Ones: HDIA input type 0: HDIA is high-speed pulse input 1: HDIA is digital input Tens: HDIB input type 0: HDIB is high-speed pulse input 1: HDIB is digital input	0	◎
P05.01	Function of S1 terminal	0: No function 1: Forward running	1	◎
P05.02	Function of S2 terminal	2: Reverse running 3: 3-wire control/Sin	4	◎
P05.03	Function of S3 terminal	4: Forward jogging 5: Reverse jogging	7	◎
P05.04	Function of S4 terminal	6: Coast to stop 7: Fault reset	0	◎
P05.05	Function of HDIA	8: Running pause	0	◎

Function code	Name	Detailed parameter description	Default value	Modify
	terminal	9: External fault input		
P05.06	Function of HDIB terminal	10: Frequency increase (UP) 11: Frequency decrease (DOWN) 12: Clear frequency increase/decrease setting 13: Switchover between setting A and setting B 14: Switchover between combination setting and A setting 15: Switchover between combination setting and setting B 16: Multi-step speed terminal 1 17: Multi-step speed terminal 2 18: Multi-step speed terminal 3 19: Multi-step speed terminal 4 20: Multi-step speed pause 21: Acceleration/deceleration time selection 1 22: Acceleration/deceleration time selection 2 23: Simple PLC stop reset 24: Simple PLC pause 25: PID control pause 26: Wobbling frequency pause 27: Wobbling frequency reset 28: Counter reset 29: Switching between speed control and torque control 30: Acceleration/deceleration disabled 31: Counter trigger 32: Reserved 33: Clear frequency increase/decrease setting temporarily 34: DC braking 35: Switch from motor 1 to motor 2 36: Command switches to keypad 37: Command switches to terminal 38: Command switches to communication 39: Pre-exciting command 40: Zero out power consumption quantity 41: Maintain power consumption quantity 42: Switching the upper torque limit setting mode to keypad	0	◎

Function code	Name	Detailed parameter description	Default value	Modify
		43: Position reference point input (valid only for S2, S3, and S4) 44: Spindle orientation disabled 45: Spindle zeroing/local position zeroing 46: Spindle zero-position setting 1 47: Spindle zero-position setting 2 48: Spindle indexing setting 1 49: Spindle indexing setting 2 50: Spindle indexing setting 3 51: Terminal for switching between position control and speed control 52: Disable pulse input 53: Eliminate position deviation 54: Switch position proportional gain 55: Enable cyclic digital positioning 56: Emergency stop 57: Motor overtemperature fault input 58: Enable rigid tapping 59: Switch to V/F control 60: Switch to FVC control 61: PID polarity switchover 62: Reserved 63: Enable servo 64: FWD max. limit 65: REV max limit 66: Zero out encoder counting 67: Pulse increase 68: Enable pulse superimposition 69: Pulse decrease 70: Electronic gear selection 71: Switch to the master 72: Switch to the slave 73: Reset the roll diameter 74: Switch winding/unwinding 75: Pre-drive 76: Disable roll diameter calculation 77: Clear alarm display 78: Manual braking 79: Trigger forced feeding interrupt		

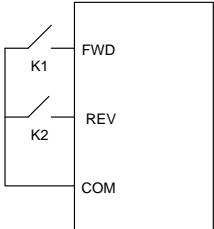
Function code	Name	Detailed parameter description	Default value	Modify															
		80: Initial roll diameter 1 81: Initial roll diameter 2 82: Trigger fire mode control 83: Switch tension PID parameters 84–95: Reserved																	
P05.07	Reserved																		
P05.08	Polarity of input terminal	This function code is used to set the polarity of input terminals. When the bit is set to 0, the input terminal polarity is positive. When the bit is set to 1, the input terminal polarity is negative. 0x00–0x3F	0x00	○															
P05.09	Digital filter time	Set the sampling filtering time of the S1–S4, HDIA, and HDIB terminals. In cases where interference is strong, increase the value of this parameter to avoid malfunction. 0.000–1.000s	0.010s	○															
P05.10	Virtual terminal setting	0x00–0x3F (0: disable, 1: enable) BIT0: S1 virtual terminal BIT1: S2 virtual terminal BIT2: S3 virtual terminal BIT3: S4 virtual terminal BIT4: HDIA virtual terminal BIT5: HDIB virtual terminal	0x00	◎															
P05.11	2/3 Wire control mode	This function code is used to set the 2/3 Wire control mode. 0: 2-Wire control 1; integrate enabling function with direction. This mode is the most popular dual-line mode. Direction of motor rotation is determined by the defined FWD/REV terminal command.  <table border="1" data-bbox="613 1220 800 1449"> <thead> <tr> <th>FWD</th> <th>REV</th> <th>Running command</th> </tr> </thead> <tbody> <tr> <td>OFF</td> <td>OFF</td> <td>Stop</td> </tr> <tr> <td>ON</td> <td>OFF</td> <td>Forward running</td> </tr> <tr> <td>OFF</td> <td>ON</td> <td>Reverse running</td> </tr> <tr> <td>ON</td> <td>ON</td> <td>Hold</td> </tr> </tbody> </table>	FWD	REV	Running command	OFF	OFF	Stop	ON	OFF	Forward running	OFF	ON	Reverse running	ON	ON	Hold	0	◎
FWD	REV	Running command																	
OFF	OFF	Stop																	
ON	OFF	Forward running																	
OFF	ON	Reverse running																	
ON	ON	Hold																	

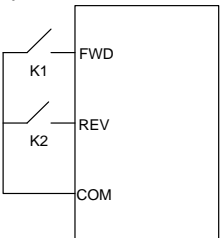
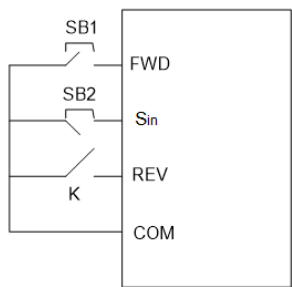
Function code	Name	Detailed parameter description	Default value	Modify																															
		<p>1: 2-wire control 2; separate enabling function with direction. In this mode, the defined FWD is enabling terminal, and the direction is determined by the state of REV.</p>  <table border="1" data-bbox="621 335 812 574"> <tr> <td>FWD</td> <td>REV</td> <td>Running command</td> </tr> <tr> <td>OFF</td> <td>OFF</td> <td>Stop</td> </tr> <tr> <td>ON</td> <td>OFF</td> <td>Forward running</td> </tr> <tr> <td>OFF</td> <td>ON</td> <td>Stop</td> </tr> <tr> <td>ON</td> <td>ON</td> <td>Reverse running</td> </tr> </table> <p>2: 3-wire control 1; This mode defines Sin as enabling terminal, and the running command is generated by FWD, the direction is controlled by REV. During running, the Sin terminal should be closed, and terminal FWD generates a rising edge signal, then the VFD starts to run in the direction set by the state of terminal REV; the VFD should be stopped by disconnecting terminal S<sub>in</sub>.</p>  <p>The direction control during running is shown below.</p> <table border="1" data-bbox="386 1197 823 1444"> <thead> <tr> <th>S<sub>in</sub></th> <th>REV</th> <th>Previous running direction</th> <th>Current running direction</th> </tr> </thead> <tbody> <tr> <td rowspan="2">ON</td> <td rowspan="2">OFF→ON</td> <td>Forward</td> <td>Reverse</td> </tr> <tr> <td>Reverse</td> <td>Forward</td> </tr> <tr> <td rowspan="2">ON</td> <td rowspan="2">ON→OFF</td> <td>Reverse</td> <td>Forward</td> </tr> <tr> <td>Forward</td> <td>Reverse</td> </tr> </tbody> </table>	FWD	REV	Running command	OFF	OFF	Stop	ON	OFF	Forward running	OFF	ON	Stop	ON	ON	Reverse running	S <sub>in</sub>	REV	Previous running direction	Current running direction	ON	OFF→ON	Forward	Reverse	Reverse	Forward	ON	ON→OFF	Reverse	Forward	Forward	Reverse		
FWD	REV	Running command																																	
OFF	OFF	Stop																																	
ON	OFF	Forward running																																	
OFF	ON	Stop																																	
ON	ON	Reverse running																																	
S <sub>in</sub>	REV	Previous running direction	Current running direction																																
ON	OFF→ON	Forward	Reverse																																
		Reverse	Forward																																
ON	ON→OFF	Reverse	Forward																																
		Forward	Reverse																																

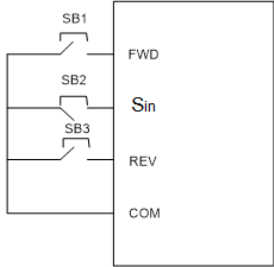

Function code	Name	Detailed parameter description	Default value	Modify																									
		<table border="1" data-bbox="385 209 826 284"> <tr> <td rowspan="2">ON→OFF</td> <td>ON</td> <td rowspan="2">Decelerate to stop</td> </tr> <tr> <td>OFF</td> </tr> </table> <p>S<sub>in</sub>: 3-wire control/S<sub>in</sub>, FWD: Forward running, REV: Reverse running</p> <p>3: 3-wire control 2; This mode defines S<sub>in</sub> as enabling terminal. The running command is generated by FWD or REV, and they control the running direction. During running, the terminal S<sub>in</sub> should be closed, and terminal FWD or REV generates a rising edge signal to control the running and direction of VFD; the VFD should be stopped by disconnecting terminal S<sub>in</sub>.</p>  <table border="1" data-bbox="385 884 826 1187"> <thead> <tr> <th>S<sub>in</sub></th> <th>FWD</th> <th>REV</th> <th>Running direction</th> </tr> </thead> <tbody> <tr> <td rowspan="2">ON</td> <td>OFF→ON</td> <td>ON</td> <td>Forward</td> </tr> <tr> <td></td> <td>OFF</td> <td>Forward</td> </tr> <tr> <td rowspan="2">ON</td> <td>ON</td> <td rowspan="2">OFF→ON</td> <td>Reverse</td> </tr> <tr> <td>OFF</td> <td>Reverse</td> </tr> <tr> <td>ON→OFF</td> <td></td> <td></td> <td>Decelerate to stop</td> </tr> </tbody> </table> <p>S<sub>in</sub>: 3-wire control/S<sub>in</sub>, FWD: Forward running, REV: Reverse running</p> <p><b>Note:</b> For dual line running mode, when FWD/REV terminal is valid, if the VFD stops due to stop command given by other sources, it will not run again after the stop command disappears even if the control terminals FWD/REV are still valid. To make the VFD run again, you need to trigger</p>	ON→OFF	ON	Decelerate to stop	OFF	S <sub>in</sub>	FWD	REV	Running direction	ON	OFF→ON	ON	Forward		OFF	Forward	ON	ON	OFF→ON	Reverse	OFF	Reverse	ON→OFF			Decelerate to stop		
ON→OFF	ON	Decelerate to stop																											
	OFF																												
S <sub>in</sub>	FWD	REV	Running direction																										
ON	OFF→ON	ON	Forward																										
		OFF	Forward																										
ON	ON	OFF→ON	Reverse																										
	OFF		Reverse																										
ON→OFF			Decelerate to stop																										

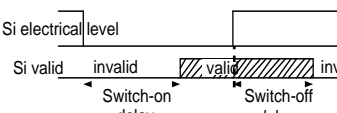
Function code	Name	Detailed parameter description	Default value	Modify
		FWD/REV again, such as PLC single-cycle stop, fixed-length stop, and valid <b>STOP/RST</b> stop during terminal control. (See P07.04.)		
P05.12	S1 terminal switch-on delay	 <p>Setting range: 0.000–50.000s</p> <p><b>Note:</b> After a virtual terminal is enabled, the state of the terminal can be changed only in communication mode. The communication address is 0x200A.</p>	0.000s	○
P05.13	S1 terminal switch-off delay		0.000s	○
P05.14	S2 terminal switch-on delay		0.000s	○
P05.15	S2 terminal switch-off delay		0.000s	○
P05.16	S3 terminal switch-on delay		0.000s	○
P05.17	S3 terminal switch-off delay		0.000s	○
P05.18	S4 terminal switch-on delay		0.000s	○
P05.19	S4 terminal switch-off delay		0.000s	○
P05.20	HDIA terminal switch-on delay		0.000s	○
P05.21	HDIA terminal switch-off delay		0.000s	○
P05.22	HDIB terminal switch-on delay		0.000s	○
P05.23	HDIB terminal switch-off delay		0.000s	○
P05.24	Lower limit value of AI1		<p>These function codes define the relation between analog input voltage and corresponding set value of analog input. When the analog input voltage exceeds the range of max./min. input, the max. input or min. input will be adopted during calculation.</p> <p>When analog input is current input, 0–20mA current corresponds to 0–10V voltage. In different applications, 100% of analog setting corresponds to different nominal values.</p>	0.00V
P05.25	Corresponding setting of lower limit of AI1	0.0%		○
P05.26	Upper limit value of AI1	10.00V		○
P05.27	Corresponding setting of upper limit of AI1	100.0%		○
P05.28	Input filter time of	The figure below illustrates several settings.		0.030s

Function code	Name	Detailed parameter description	Default value	Modify
	AI1	<p>Input filter time: Adjust the sensitivity of analog input, increase this value properly can enhance the anti-interference capacity of analog variables; however, it will also degrade the sensitivity of analog input.</p> <p><b>Note:</b> AI1 can support 0–10V/0–20mA input, when AI1 selects 0–20mA input; the corresponding voltage of 20mA is 10V; AI2 supports -10V–+10V input.</p>		
P05.29	Lower limit value of AI2		-10.00V	<input type="radio"/>
P05.30	Corresponding setting of lower limit of AI2		-100.0%	<input type="radio"/>
P05.31	Intermediate value 1 of AI2		0.00V	<input type="radio"/>
P05.32	Corresponding setting of intermediate value 1 of AI2		0.0%	<input type="radio"/>
P05.33	Intermediate value 2 of AI2		0.00V	<input type="radio"/>
P05.34	Corresponding setting of intermediate value 2 of AI2		0.0%	<input type="radio"/>
P05.35	Upper limit value of AI2		10.00V	<input type="radio"/>
P05.36	Corresponding setting of upper limit of AI2		100.0%	<input type="radio"/>
P05.37	Input filter time of AI2		Setting range of P05.24: 0.00V–P05.26 Setting range of P05.25: -300.0%–300.0% Setting range of P05.26: P05.24–10.00V Setting range of P05.27: -300.0%–300.0% Setting range of P05.28: 0.000s–10.000s Setting range of P05.29: -10.00V–P05.31 Setting range of P05.30: -300.0%–300.0% Setting range of P05.31: P05.29–P05.33 Setting range of P05.32: -300.0%–300.0% Setting range of P05.33: P05.31–P05.35 Setting range of P05.34: -300.0%–300.0% Setting range of P05.35: P05.33–10.00V Setting range of P05.36: -300.0%–300.0% Setting range of P05.37: 0.000s–10.000s	0.030s
P05.38	HDIA high-speed pulse input function	0: Set input via frequency 1: Reserved 2: Input via encoder, used in combination with HDIB	0	<input checked="" type="radio"/>
P05.39	Lower limit frequency of	0.000 kHz – P05.41	0.000 kHz	<input type="radio"/>

Function code	Name	Detailed parameter description	Default value	Modify
	HDIA			
P05.40	Corresponding setting of lower limit frequency of HDIA	-300.0%–300.0%	0.0%	<input type="radio"/>
P05.41	Upper limit frequency of HDIA	P05.39–50.000kHz	50.000 kHz	<input type="radio"/>
P05.42	Corresponding setting of upper limit frequency of HDIA	-300.0%–300.0%	100.0%	<input type="radio"/>
P05.43	HDIA frequency input filter time	0.000s–10.000s	0.030s	<input type="radio"/>
P05.44	HDIB high-speed pulse input function selection	0: Set input via frequency 1: Reserved 2: Encoder input, it should be used in combination with HDIA	0	<input checked="" type="radio"/>
P05.45	Lower limit frequency of HDIB	0.000 kHz – P05.47	0.000 kHz	<input type="radio"/>
P05.46	Corresponding setting of lower limit frequency of HDIB	-300.0%–300.0%	0.0%	<input type="radio"/>
P05.47	Upper limit frequency of HDIB	P05.45–50.000kHz	50.000 kHz	<input type="radio"/>
P05.48	Corresponding setting of upper limit frequency of HDIB	-300.0%–300.0%	100.0%	<input type="radio"/>
P05.49	HDIB frequency input filter time	0.000s–10.000s	0.030s	<input type="radio"/>
P05.50	A11 input signal type	0: Voltage type 1: Current type <b>Note:</b> You can set the A11 input signal type through the corresponding function code.	0	<input checked="" type="radio"/>

Function code	Name	Detailed parameter description	Default value	Modify
P05.51–P05.52	Reserved			

**P06 group—Output terminals**

Function code	Name	Detailed parameter description	Default value	Modify
P06.00	HDO output type	0: Open collector high-speed pulse output: Max. frequency of the pulse is 50.00kHz. For details about the related functions, see P06.27–P06.31. 1: Open collector output: For details about the related functions, see P06.02.	0	☉
P06.01	Y1 output selection	0: Invalid 1: In running	0	○
P06.02	HDO output selection	2: In forward running 3: In reverse running	0	○
P06.03	Relay RO1 output selection	4: In jogging 5: VFD fault	1	○
P06.04	Relay RO2 output selection	6: Frequency level detection FDT1 7: Frequency level detection FDT2 8: Frequency reached 9: Running in zero speed 10: Reach upper limit frequency 11: Reach lower limit frequency 12: Ready to run 13: In pre-exciting 14: Overload pre-alarm 15: Underload pre-alarm 16: Simple PLC stage completed 17: Simple PLC cycle completed 18: Reach set counting value 19: Reach designated counting value 20: External fault is valid 21: Reserved 22: Reach running time 23: Virtual terminal output of Modbus/Modbus TCP communication 24: Virtual terminal output of CANopen communication 25: Virtual terminal output of Ethernet	5	○

Function code	Name	Detailed parameter description	Default value	Modify
		communication 26: DC bus voltage established 27: Z pulse output 28: During pulse superposition 29: STO action 30: Positioning completed 31: Spindle zeroing completed 32: Spindle scale-division completed 33: Speed limit reached in torque control 34: Virtual terminal output of EtherCAT/PROFINET/EtherNet IP communication 35: Reserved 36: Speed/position control switchover completed 37: Any frequency reached 38–40: Reserved 41: Y1 from the programmable card 42: Y2 from the programmable card 43: HDO from the programmable card 44: RO1 from the programmable card 45: RO2 from the programmable card 46: RO3 from the programmable card 47: RO4 from the programmable card 48: EC PT100 detected OH pre-alarm 49: EC PT1000 detected OH pre-alarm 50: AI/AO detected OH pre-alarm 51: Stopped or running at zero speed 52: Disconnection detected in tension control 53: Roll diameter setting reached 54: Max. roll diameter reached 55: Min. roll diameter reached 56: Fire control mode enabled 57: S1 terminal status 58: S2 terminal status 59: S3 terminal status 60: S4 terminal status 61: HDIA terminal status 62: HDIB terminal status 63: Brake release output 64: VFD fault (except STO and STL 1–3)		

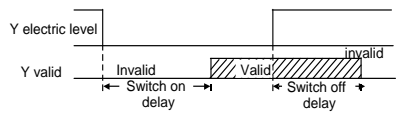
Function code	Name	Detailed parameter description	Default value	Modify								
P06.05	Output terminal polarity selection	<p>Used to set the polarity of output terminals.</p> <p>When the bit is set to 0, output terminal polarity is positive;</p> <p>When the bit is set to 1, output terminal polarity is negative.</p> <table border="1" style="margin-left: 20px;"> <tr> <td>BIT3</td> <td>BIT2</td> <td>BIT1</td> <td>BIT0</td> </tr> <tr> <td>RO2</td> <td>RO1</td> <td>HDO</td> <td>Y1</td> </tr> </table> <p>Setting range: 0x00–0x0F</p>	BIT3	BIT2	BIT1	BIT0	RO2	RO1	HDO	Y1	0x00	○
BIT3	BIT2	BIT1	BIT0									
RO2	RO1	HDO	Y1									
P06.06	Y switch-on delay	<p>Used to define the corresponding delay of the level variation from switch-on to switch-off.</p>  <p>Y electric level</p> <p>Y valid Invalid Valid Invalid</p> <p>Switch on delay Switch off delay</p>	0.000s	○								
P06.07	Y switch-off delay		0.000s	○								
P06.08	HDO switch-on delay		0.000s	○								
P06.09	HDO switch-off delay		0.000s	○								
P06.10	Relay RO1 switch-on delay		0.000s	○								
P06.11	Relay RO1 switch-off delay		Setting range: 0.000–50.000s <b>Note:</b> P06.08 and P06.09 are valid only when P06.00=1.	0.000s	○							
P06.12	Relay RO2 switch-on delay		0.000s	○								
P06.13	Relay RO2 switch-off delay		0.000s	○								
P06.14	AO1 output selection		0: Running frequency (0–Max. output frequency)	0	○							
P06.15	Reserved	1: Set frequency (0–Max. output frequency)										
P06.16	HDO high-speed pulse output	2: Ramp reference frequency (0–Max. output frequency)	0	○								
		3: Rotational speed (100% corresponds to the speed at max. output frequency.)										
		4: Output current (100% corresponds to twice the VFD rated current.)										
		5: Output current (100% corresponds to twice the motor rated current.)										
		6: Output voltage (100% corresponds to 1.5 times the VFD rated voltage.)										
		7: Output power (100% corresponds to twice the motor rated power.)										
		8: Set torque (100% corresponds to twice the motor rated current.)										

Function code	Name	Detailed parameter description	Default value	Modify
		<p>9: Output torque (Absolute value; 100% corresponds to twice the motor rated torque.)</p> <p>10: AI1 input (0–10V/0–20mA)</p> <p>11: AI2 input (0–10V)</p> <p>12: AI3 input (0–10V/0–20mA)</p> <p>13: HDIA input (0.00–50.00kHz)</p> <p>14: Value 1 set through Modbus communication (0–1000)</p> <p>15: Value 2 set through Modbus communication (0–1000)</p> <p>16: Value 1 set through CANopen (0–1000)</p> <p>17: Value 2 set through CANopen (0–1000)</p> <p>18: Value 1 set through Ethernet 1 (0–1000)</p> <p>19: Value 2 set through Ethernet 2 (0–1000)</p> <p>20: HDIB input (0.00–50.00kHz)</p> <p>21: Value 1 set through EtherCAT/PROFINET/EtherNet IP (0–1000)</p> <p>22: Torque current (bipolar; 100% corresponds to triple the motor rated current.)</p> <p>23: Exciting current (bipolar; 100% corresponds to triple the motor rated current.)</p> <p>24: Set frequency (bipolar; 0–Max. output frequency)</p> <p>25: Ramp reference frequency (bipolar; 0–Max. output frequency)</p> <p>26: Rotational speed (bipolar; 0–Speed corresponding to max. output frequency)</p> <p>27: Value 2 set through EtherCAT/PROFINET/EtherNet IP communication (0–1000)</p> <p>28: AO1 from the programmable card (0–1000)</p> <p>29: AO2 from the programmable card (0–1000)</p> <p>30: Rotational speed (100% corresponds to twice the motor rated synchronous speed)</p> <p>31: Output torque (Actual value, 100% corresponds to twice the motor rated torque)</p> <p>32: AI/AO temperature detection output</p> <p>33–63: Reserved</p> <p><b>Note:</b></p>		

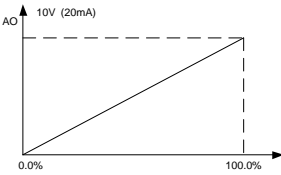

Function code	Name	Detailed parameter description	Default value	Modify
		When AO1 is of the current output type, 100% corresponds to 20mA; when AO1 is of the voltage output type, 100% corresponds to 10V; 100% of HDO corresponds to the output of P06.30.		
P06.17	Lower limit of AO1 output	Above function codes define the relation between output value and analog output. When the output value exceeds the set max./min. output range, the upper/low limit of output will be adopted during calculation.  When analog output is current output, 1mA corresponds to 0.5V voltage. In different applications, 100% of output value corresponds to different analog outputs.	0.0%	<input type="radio"/>
P06.18	Corresponding AO1 output of lower limit		0.00V	<input type="radio"/>
P06.19	Upper limit of AO1 output		100.0%	<input type="radio"/>
P06.20	Corresponding AO1 output of upper limit		10.00V	<input type="radio"/>
P06.21	AO1 output filter time	 <p>Setting range of P06.17: -300.0%–P06.19                      Setting range of P06.18: 0.00V–10.00V                      Setting range of P06.19: P06.17–300.0%                      Setting range of P06.20: 0.00V–10.00V                      Setting range of P06.21: 0.000s–10.000s</p>	0.000s	<input type="radio"/>
P06.22	Reserved			
P06.23	PTC constant output current setting	0.000–20.000mA	4.000mA	<input type="radio"/>
P06.24	PTC resistance alarm threshold	0–60000Ω	750Ω	<input type="radio"/>
P06.25	PTC resistance alarm recovery threshold	0–60000Ω	150Ω	<input type="radio"/>
P06.26	Actual PTC resistance	0–60000Ω	0Ω	<input checked="" type="radio"/>
P06.27	Lower limit of HDO output	-300.0%–P06.29	0.00%	<input type="radio"/>
P06.28	Corresponding HDO output of	0.00–50.00kHz	0.00kHz	<input type="radio"/>

Function code	Name	Detailed parameter description	Default value	Modify
	lower limit			
P06.29	Upper limit of HDO output	P06.27–300.0%	100.0%	○
P06.30	Corresponding HDO output of upper limit	0.00–50.00kHz	50.00 kHz	○
P06.31	HDO output filter time	0.000s–10.000s	0.000s	○
P06.32	Reserved			
P06.33	Frequency reach detection value	0.00Hz–P00.03	1.00Hz	○
P06.34	Frequency reach detection time	0.0–3600.0s	0.5s	○

**P07 group—HMI**

Function code	Name	Detailed parameter description	Default value	Modify
P07.00	User password	<p>0–65535</p> <p>Set it to any non-zero value to enable password protection.</p> <p>00000: Clear previous user password and disable password protection.</p> <p>After user password becomes valid, if wrong password is inputted, you will be denied entry. It is necessary to keep the user password in mind.</p> <p>Password protection will be effective one minute after exiting function code edit state, and it will display "0.0.0.0.0" if you press <b>PRG/ESC</b> key to enter function code edit state again, you need to input the correct password.</p> <p><b>Note:</b> Restoring to default values will clear user password. Exercise caution when using this function.</p>	0	○
P07.01	Reserved			
P07.02	Function of keys	<p>Range: 0x00–0x27</p> <p>Ones: Function selection of <b>QUICK/JOG</b> key</p> <p>0: No function</p> <p>1: Jogging</p> <p>2: Reserved</p>	0x01	◎

Function code	Name	Detailed parameter description	Default value	Modify
		3: Forward/reverse rotation switchover 4: Clear <b>UP/DOWN</b> setting 5: Coast to stop 6: Switch over the running command reference mode in sequence 7: Reserved Tens: Reserved		
P07.03	Running command channel switchover sequence of <b>QUICK</b> key	When P07.02=6, set the switchover sequence of running command channel. 0: keypad control → terminal control → communication control 1: keypad control ←→ terminal control 2: keypad control ←→ communication control 3: terminal control ←→ communication control	0	○
P07.04	Stop function selection of <b>STOP/RST</b> key	Validness selection of stop function of <b>STOP/RST</b> . For fault reset, <b>STOP/RST</b> is valid under any situation. 0: valid only for panel control only 1: valid for both panel and terminal control 2: valid for both panel and communication control 3: valid for all control modes	0	○
P07.05	Selection 1 of parameters displayed in running state	0x0000–0xFFFF BIT0: Running frequency (Hz on) BIT1: Set frequency (Hz blinking) BIT2: Bus voltage (V on) BIT3: Output voltage (V on) BIT4: Output current (A on) BIT5: Rotational speed (rpm on) BIT6: Output power (% on) BIT7: Output torque (% on) BIT8: PID reference value (% blinking) BIT9: PID feedback value (% on) BIT10: Input terminal status BIT11: Output terminal status BIT12: Torque setting (% on) BIT13: Pulse counting BIT14: Motor overload percentage (% on) BIT15: PLC and multi-step speed actual step number	0x03FF	○

Function code	Name	Detailed parameter description	Default value	Modify
P07.06	Selection 2 of parameters displayed in running state	0x0000–0xFFFF BIT0: AI1 value (V on) BIT1: AI2 value (V on) BIT2: AI3 value (V on) BIT3: HDIA frequency BIT4: HDIB frequency BIT5: VFD overload percentage (% on) BIT6: Ramp frequency reference value (Hz on) BIT7: Linear speed BIT8: AC incoming current BIT9: Frequency upper limit BIT10–BIT15: Reserved	0x0000	○
P07.07	Selection of parameters displayed in stopped state	0x0000–0xFFFF BIT0: Set frequency (Hz on, frequency blinking slowly) BIT1: Bus voltage (V on) BIT2: Input terminal status BIT3: Output terminal status BIT4: PID reference value (% blinking) BIT5: PID feedback value (% on) BIT6: Torque setting (% on) BIT7: AI1 value (V on) BIT8: AI2 value (V on) BIT9: AI3 value (V on) BIT10: HDIA frequency BIT11: HDIB frequency BIT12: Counting BIT13: PLC and multi-step speed actual step number BIT14: Frequency upper limit BIT15: Reserved	0x00FF	○
P07.08	Frequency display coefficient	0.01–10.00 Display frequency=running frequency× P07.08	1.00	○
P07.09	Speed display coefficient	0.1–999.9% Mechanical speed=120×display running frequency×P07.09/number of motor pole pairs	100.0%	○
P07.10	Linear speed display coefficient	0.1–999.9% Linear speed=mechanical speed×P07.10	1.0%	○
P07.11	Temperature of	-20.0–120.0°C	0.0°C	●

Function code	Name	Detailed parameter description	Default value	Modify
	rectifier bridge module			
P07.12	Temperature of inverter module	-20.0–120.0°C	0.0°C	●
P07.13	Software version of control board	1.00–655.35	Depends on version	●
P07.14	Accumulated running time	0–65535h	0h	●
P07.15	High bit of VFD power consumption	Display the power consumption of the VFD. VFD power consumption=P07.15×1000+P07.16	0kWh	●
P07.16	Low bit of VFD power consumption	Setting range of P07.15: 0–65535 kWh (×1000) Setting range of P07.16: 0.0–999.9 kWh	0.0kWh	●
P07.18	Rated power of VFD	0.4–3000.0kW	Depends on model	●
P07.19	Rated voltage of VFD	50–1200V	Depends on model	●
P07.20	Rated current of VFD	0.1–6000.0A	Depends on model	●
P07.21	Factory barcode 1	0x0000–0xFFFF	Depends on model	●
P07.22	Factory barcode 2	0x0000–0xFFFF	Depends on model	●
P07.23	Factory barcode 3	0x0000–0xFFFF	Depends on model	●
P07.24	Factory barcode 4	0x0000–0xFFFF	Depends on model	●
P07.25	Factory barcode 5	0x0000–0xFFFF	Depends on model	●
P07.26	Factory barcode 6	0x0000–0xFFFF	Depends on model	●
P07.27	Type at present fault	0: No fault 1: Inverter unit U phase protection (OUT1)	0	●
P07.28	Type of the last fault	2: Inverter unit V phase protection (OUT2) 3: Inverter unit W phase protection (OUT3)	0	●
P07.29	Type of the 2nd-	4: Overcurrent during acceleration (OC1)	0	●

Function code	Name	Detailed parameter description	Default value	Modify
	last fault	5: Overcurrent during deceleration (OC2)		
P07.30	Type of the 3rd-last fault	6: Overcurrent during constant speed (OC3) 7: Overvoltage during acceleration (OV1)	0	●
P07.31	Type of the 4th-last fault	8: Overvoltage during deceleration (OV2) 9: Overvoltage during constant speed (OV3)	0	●
P07.32	Type of the 5th-last fault	10: Bus undervoltage fault (UV) 11: Motor overload (OL1) 12: VFD overload (OL2) 13: Phase loss on input side (SPI) 14: Phase loss on output side (SPO) 15: Rectifier module overheat (OH1) 16: Inverter module overheat (OH2) 17: External fault (EF) 18: Modbus/Modbus TCP communication fault (CE) 19: Current detection fault (ItE) 20: Motor autotuning fault (tE) 21: EEPROM operation fault (EEP) 22: PID feedback offline fault (PIDE) 23: Brake unit fault (bCE) 24: Running time reached (END) 25: Electronic overload (OL3) 26: Keypad communication error (PCE) 27: Parameter upload error (UPE) 28: Parameter download error (DNE) 30: Ethernet communication fault (E-NET) 31: CANopen communication fault (E-CAN) 32: To-ground short-circuit fault 1 (ETH1) 33: To-ground short-circuit fault 2 (ETH2) 34: Speed deviation fault (dEu) 35: Mal-adjustment fault (STo) 36: Underload fault (LL) 37: Encoder offline fault (ENC1o) 38: Encoder reversal fault (ENC1d) 39: Encoder Z pulse offline fault (ENC1Z) 40: Safe torque off (STO) 41: Channel H1 safety circuit exception (STL1) 42: Channel H2 safety circuit exception (STL2) 43: Channel H1 and H2 exception (STL3)	0	●

Function code	Name	Detailed parameter description	Default value	Modify
		44: Safety code FLASH CRC fault (CrCE) 45: Programmable card customized fault 1 (P-E1) 46: Programmable card customized fault 2 (P-E2) 47: Programmable card customized fault 3 (P-E3) 48: Programmable card customized fault 4 (P-E4) 49: Programmable card customized fault 5 (P-E5) 50: Programmable card customized fault 6 (P-E6) 51: Programmable card customized fault 7 (P-E7) 52: Programmable card customized fault 8 (P-E8) 53: Programmable card customized fault 9 (P-E9) 54: Programmable card customized fault 10 (P-E10) 55: Duplicate card type(E-Err) 56: Encoder UVW loss fault (ENCUV) 58: CANopen communication fault (SECAN) 59: Motor over-temperature fault (OT) 60: Failure to identify the card at slot 1 (F1-Er) 61: Failure to identify the card at slot 2 (F2-Er) 62: Failure to identify the card at slot 3 (F3-Er) 63: Communication timeout of the card at slot 1 (C1-Er) 64: Communication timeout of the card at slot 2 (C2-Er) 65: Communication timeout of the card at slot 3 (C3-Er) 66: EtherCAT communication fault (E-CAT) 69: CAN slave fault in master/slave synchronization (S-Err) 70: EC PT100 detected overheating (OtE1) 71: EC PT1000 detected overheating (OtE2) 72: EtherNet/IP communication timeout (E-EIP) 73: No upgrade bootloader (E-PAO) 74: AI1 disconnected (E-AI1) 75: AI2 disconnected (E-AI2) 76: AI3 disconnected (E-AI3) 77: AI/AO detected overheating (OH3) 78: Brake feedback fault (E-brF) 79: Stalling in V/F control (E-StK) 80: Out-of-step in V/F control (E-LSt)		

Function code	Name	Detailed parameter description	Default value	Modify
P07.33	Running frequency at present fault	0.00Hz~P00.03	0.00Hz	●
P07.34	Ramp reference frequency at present fault	0.00Hz~P00.03	0.00Hz	●
P07.35	Output voltage at present fault	0~1200V	0V	●
P07.36	Output current at present fault	0.0~6300.0A	0.0A	●
P07.37	Bus voltage at present fault	0.0~2000.0V	0.0V	●
P07.38	Max. temperature at present fault	-20.0~120.0°C	0.0°C	●
P07.39	Input terminal state at present fault	0x0000~0xFFFF	0x0000	●
P07.40	Output terminal state at present fault	0x0000~0xFFFF	0x0000	●
P07.41	Running frequency at last fault	0.00Hz~P00.03	0.00Hz	●
P07.42	Ramp reference frequency at last fault	0.00Hz~P00.03	0.00Hz	●
P07.43	Output voltage at last fault	0~1200V	0V	●
P07.44	Output current at last fault	0.0~6300.0A	0.0A	●
P07.45	Bus voltage at last fault	0.0~2000.0V	0.0V	●
P07.46	Max. temperature at last fault	-20.0~120.0°C	0.0°C	●
P07.47	Input terminal state at last fault	0x0000~0xFFFF	0x0000	●
P07.48	Output terminal state at last fault	0x0000~0xFFFF	0x0000	●



Function code	Name	Detailed parameter description	Default value	Modify
P07.49	Running frequency at 2nd-last fault	0.00Hz–P00.03	0.00Hz	●
P07.50	Ramp reference frequency at 2nd-last fault	0.00Hz–P00.03	0.00Hz	●
P07.51	Output voltage at 2nd-last fault	0–1200V	0V	●
P07.52	Output current at 2nd-last fault	0.0–6300.0A	0.0A	●
P07.53	Bus voltage at 2nd-last fault	0.0–2000.0V	0.0V	●
P07.54	Max. temperature at 2nd-last fault	-20.0–120.0°C	0.0°C	●
P07.55	Input terminal state at 2nd-last fault	0x0000–0xFFFF	0x0000	●
P07.56	Output terminal state at 2nd-last fault	0x0000–0xFFFF	0x0000	●

**P08 group—Enhanced functions**

Function code	Name	Detailed parameter description	Default value	Modify
P08.00	Acceleration time 2	See P00.11 and P00.12 for detailed definitions. UMI-B7 series VFD defines four groups of acceleration/deceleration time, which can be selected by multifunction digital input terminal (P05 group). The acceleration/deceleration time of the VFD is the first group by default. Setting range: 0.0–3600.0s	Depends on model	○
P08.01	Deceleration time 2		Depends on model	○
P08.02	Acceleration time 3		Depends on model	○
P08.03	Deceleration time 3		Depends on model	○
P08.04	Acceleration time 4		Depends on model	○
P08.05	Deceleration time 4		Depends on model	○
P08.06	Running frequency of jogging	Used to define the reference frequency of the VFD during jogging. Setting range: 0.00Hz–P00.03 (Max. output	5.00Hz	○

Function code	Name	Detailed parameter description	Default value	Modify
		frequency)		
P08.07	Acceleration time of jogging	Jogging acceleration time is the time needed for the VFD to accelerate from 0Hz to Max. output frequency (P00.03).	Depends on model	<input type="radio"/>
P08.08	Deceleration time of jogging	Jogging deceleration time is the time needed from decelerating from Max. output frequency (P00.03) to 0Hz. Setting range: 0.0–3600.0s		<input type="radio"/>
P08.09	Jump frequency 1	When the set frequency is within the range of jump frequency, the VFD will run at the boundary of jump frequency. The VFD can avoid mechanical resonance point by setting the jump frequency, and three jump frequency points can be set. If the jump frequency points are set to 0, this function will be invalid.	0.00Hz	<input type="radio"/>
P08.10	Jump frequency amplitude 1		0.00Hz	<input type="radio"/>
P08.11	Jump frequency 2		0.00Hz	<input type="radio"/>
P08.12	Jump frequency amplitude 2		0.00Hz	<input type="radio"/>
P08.13	Jump frequency 3		0.00Hz	<input type="radio"/>
P08.14	Jump frequency amplitude 3	<p>Setting range: 0.00Hz–P00.03 (Max. output frequency)</p>	0.00Hz	<input type="radio"/>
P08.15	Amplitude of wobbling frequency	0.0–100.0% (relative to set frequency)	0.0%	<input type="radio"/>
P08.16	Amplitude of jump frequency	0.0–50.0% (relative to amplitude of wobbling frequency)	0.0%	<input type="radio"/>
P08.17	Rise time of wobbling frequency	0.1–3600.0s	5.0s	<input type="radio"/>
P08.18	Descend time of wobbling frequency	0.1–3600.0s	5.0s	<input type="radio"/>
P08.19	Switching frequency of acceleration/deceleration time	0.00–P00.03 (Max. output frequency) 0.00Hz: no switchover Switch to acceleration/deceleration time 2 if the running frequency is larger than P08.19	0.00Hz	<input type="radio"/>

Function code	Name	Detailed parameter description	Default value	Modify
P08.20	Frequency threshold of the start of droop control	0.00–50.00Hz	2.00Hz	<input type="radio"/>
P08.21	Reference frequency of acceleration/deceleration time	0: Max. output frequency 1: Set frequency 2: 100Hz <b>Note:</b> Valid for straight acceleration/deceleration only	0	<input checked="" type="radio"/>
P08.22	Output torque display selection	0: Based on torque current 1: Based on output power	0	<input type="radio"/>
P08.23	Number of decimal points of frequency	0: Two decimal points 1: One decimal point	0	<input type="radio"/>
P08.24	Number of decimal points of linear speed	0: No decimal point 1: One 2: Two 3: Three	0	<input type="radio"/>
P08.25	Set count value	P08.26–65535	0	<input type="radio"/>
P08.26	Designated count value	0–P08.25	0	<input type="radio"/>
P08.27	Set running time	0–65535min	0min	<input type="radio"/>
P08.28	Automatic fault reset times	Automatic fault reset times: When the VFD selects automatic fault reset, it is used to set the times of automatic reset, if the continuous reset times exceeds the value set by P08.29, the VFD will report fault and stop to wait for repair.	0	<input type="radio"/>
P08.29	Automatic fault reset time interval	Interval of automatic fault reset: select the interval time from when fault occurred to automatic fault reset actions. After VFD starts, if no fault occurred during 60s, the fault reset times will be zeroed out. Setting range of P08.28: 0–10 Setting range of P08.29: 0.1–3600.0s	1.0s	<input type="radio"/>
P08.30	Reduction ratio of droop control	This function code sets the variation rate of VFD output frequency based on the load; it is mainly used in balancing the power when multiple motors drive the same load.	0.00Hz	<input type="radio"/>

Function code	Name	Detailed parameter description	Default value	Modify
		Setting range: 0.00–50.00Hz		
P08.31	Switchover between motor 1 and motor 2	0x00–0x14 Ones: Switchover channel 0: Terminal 1: Modbus/Modbus TCP communication 2: CANopen communication 3: Ethernet communication 4: EtherCAT/PROFINET/EtherNet IP communication Tens: indicates whether to enable switchover during running 0: Disable 1: Enable	0x00	☉
P08.32	FDT1 level detection value	When the output frequency exceeds the corresponding frequency of FDT level, multifunction digital output terminal outputs "frequency level detection FDT" signal, this signal will be valid until the output frequency lowers to below the corresponding frequency (FDT level-FDT lag detection value), the waveform is shown in the figure below.	60.00Hz	○
P08.33	FDT1 lag detection value		5.0%	○
P08.34	FDT2 level detection value		60.00Hz	○
P08.35	FDT2 lag detection value		5.0%	○
		<p>Setting range of P08.32: 0.00Hz–P00.03 (Max. output frequency) Setting range of P08.33: 0.0–100.0% (FDT1 level) Setting range of P08.34: 0.00Hz–P00.03 (Max. output frequency) Setting range of P08.35: 0.0–100.0% (FDT2 level)</p>		
P08.36	Detection value for frequency arrival	When the output frequency is within the positive /negative detection range of the set frequency, the multifunction digital output terminal outputs "frequency arrival" signal as shown below.	0.00Hz	○

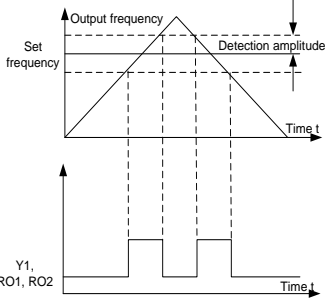
Function code	Name	Detailed parameter description	Default value	Modify								
		 <p>Setting range: 0.00Hz~P00.03 (Max. output frequency)</p>										
P08.37	Enable/disable energy-consumption braking	0: Disable energy-consumption 1: Enable energy-consumption	1	○								
P08.38	Energy-consumption braking threshold voltage	After setting the original bus voltage to brake the energy, adjust this value properly to brake the load. The default value will change with the change of voltage class. Setting range: 200.0~2000.0V To prevent customers from setting a too large value, the recommended setting range is as follows: <table border="1" data-bbox="375 973 834 1109"> <tr> <td>Voltage class</td> <td>220V</td> <td>460V</td> <td>575V</td> </tr> <tr> <td>Setting range</td> <td>360~390V</td> <td>715~780V</td> <td>950~1050V</td> </tr> </table>	Voltage class	220V	460V	575V	Setting range	360~390V	715~780V	950~1050V	220V voltage: 380.0V; 460V voltage: 740.0V; 575V voltage: 1000.0V	○
Voltage class	220V	460V	575V									
Setting range	360~390V	715~780V	950~1050V									
P08.39	Running mode of cooling fan	0: Common running mode 1: The fan keeps running after power up 2: Running mode 2	0	○								
P08.40	PWM selection	0x0000~0x1121 Ones place: PWM mode selection 0: PWM mode 1, 3PH modulation and 2PH modulation 1: PWM mode 2, 3PH modulation Tens place: PWM low-speed carrier limit 0: Low-speed carrier limit mode 1 1: Low-speed carrier limit mode 2	0x1101	◎								

Function code	Name	Detailed parameter description	Default value	Modify
		2: No limit Hundreds place: Deadzone compensation method 0: Compensation method 1 1: Compensation method 2 Thousands place: PWM loading mode selection 0: Interruptive loading 1: Normal loading		
P08.41	Overmodulation selection	0x00–0x1111 Ones place: Whether to enable overmodulation 0: Disable overmodulation 1: Enable overmodulation Tens place: Overmodulation mode 0: Mild overmodulation 1: Deepened overmodulation Hundreds: Carrier frequency limit 0: Yes 1: No Thousands: Output voltage compensation 0: No 1: Yes	0x1001	◎
P08.42	LED keypad control setting	0x0000–0x1223 Ones place: Frequency control enabling selection 0: Controls through both the Up/Down key and digital potentiometer are valid. 1: Only control through the Up/Down key is valid. 2: Only control through the digital potentiometer is valid. 3: Controls through the Up/Down key and digital potentiometer are invalid. Tens place: Frequency control selection 0: Valid only when P00.06=0 or P00.07=0 1: Valid for all frequency setting methods 2: Invalid for multi-step speed running when multi-step speed running has the priority Hundreds place: Action selection for stop 0: Setting is valid. 1: Valid during running, cleared after stop 2: Valid during running, cleared after a stop command is received	0x0000	○

Function code	Name	Detailed parameter description	Default value	Modify
		Thousands place: Indicates whether to enable the integral function through the Up/Down key and digital potentiometer 0: Enable the integral function 1: Disable the integral function		
P08.43	LED keypad potentiometer integral rate	0.01–10.00s	0.10	○
P08.44	<u>UP/DOWN</u> terminal control setting	0x000–0x221 Ones: Frequency control selection 0: <u>UP/DOWN</u> terminal setting is valid 1: <u>UP/DOWN</u> terminal setting is invalid Tens: Frequency control selection 0: Valid only when P00.06=0 or P00.07=0 1: All frequency modes are valid 2: Invalid for multi-step speed when multi-step speed takes priority Hundreds: Action selection during stop 0: Valid 1: Valid at running, cleared after stop 2: Valid at running, cleared upon a stop command	0x000	○
P08.45	UP terminal frequency incremental integral rate	0.01–50.00Hz/s <b>Note:</b> The value is also used as the frequency increment or decrement that is made by pressing the UP/DOWN key on the LCD pad.	0.50Hz/s	○
P08.46	DOWN terminal frequency decrement change rate	0.01–50.00Hz/s	0.50Hz/s	○
P08.47	Action selection for frequency setting during power down	0x000–0x111 Ones place: Action selection at power-off during frequency adjusting through digitals. 0: Save the setting at power-off. 1: Clear the setting at power-off. Action selection at power-off during frequency adjusting through Modbus/Modbus TCP communication 0: Save the setting at power-off. 1: Clear the setting at power-off.	0x000	○

Function code	Name	Detailed parameter description	Default value	Modify
		Hundreds place: Action selection at power-off during frequency adjusting through DP communication 0: Save the setting at power-off. 1: Clear the setting at power-off.		
P08.48	High bit of initial value of power consumption	Set the initial value of power consumption. Initial value of power consumption=P08.48×1000 + P08.49 Setting range of P08.48: 0–59999 kWh (k) Setting range of P08.49: 0.0–999.9 kWh	0kWh	○
P08.49	Low bit of initial value of power consumption		0.0kWh	○
P08.50	Flux braking	This function code is used to enable flux braking function. 0: Invalid 100–150: The larger the coefficient, the stronger the braking intensity The VFD enables motor to decelerate quickly by increasing the motor flux which converts energy generated during braking into thermal energy. The VFD monitors motor state continuously even during flux braking, thus flux braking can be applied in motor stop or used to change motor speed. The flux braking also carries the following advantages. 1) Brake immediately after sending stop command, removing the need to wait for flux to attenuate. 2) Better cooling effect. During flux braking, the stator current of the motor increases, while the rotor current does not change, while the cooling effect of stator is much more effective than that of the rotor.	0	○
P08.51	VFD input power factor	This function code is used to adjust the current display value on the AC input side. 0.00–1.00	0.56	○
P08.52	STO lock	0: STO alarm lock Alarm-lock means STO alarm must be reset after state restoration when STO occurs. 1: STO alarm unlock Alarm-unlock means when STO occurs, after state	0	○



Function code	Name	Detailed parameter description	Default value	Modify
		restoration, STO alarm will disappear automatically.		
P08.53	Bias value of upper limit frequency of torque control	0.00 Hz–P00.03 (Max. output frequency) <b>Note:</b> This parameter is valid only for the torque control mode.	0.00Hz	<input type="radio"/>
P08.54	Acceleration/ deceleration selection of upper limit frequency of torque control	0: No limit on acceleration or deceleration 1: Acceleration/deceleration time 1 2: Acceleration/deceleration time 2 3: Acceleration/deceleration time 3 4: Acceleration/deceleration time 4	0	<input type="radio"/>
P08.55	Enabling auto carrier frequency reduction	0: Disable 1: Enable <b>Note:</b> Automatic carrier frequency reduction indicates that the VFD automatically reduces the carrier frequency when detecting the heat sink temperature exceeds the rated temperature. When the temperature decreases to a certain degree, the carrier frequency recovers. This function reduces the chance of VFD overheat alarm.	0	<input type="radio"/>
P08.56	Actual carrier frequency	0.0–15.0kHz	Depends on model	<input checked="" type="radio"/>
P08.57	Temperature point of auto carrier frequency reduction	40.0–85.0°C	70.0°C	<input type="radio"/>
P08.58	Interval of carrier frequency reduction	0–30min The value 0 indicates carrier frequency reduction is invalid.	10min	<input type="radio"/>
P08.59	AI1 disconnection detection threshold	0–100%	0	<input type="radio"/>
P08.60	AI2 disconnection detection threshold	0–100%	0	<input type="radio"/>
P08.61	AI3 disconnection detection threshold	0–100%	0	<input type="radio"/>

Function code	Name	Detailed parameter description	Default value	Modify
P08.62	Output current filter time	0.000–10.000s	0.000	<input type="radio"/>
P08.63	Output torque filter times	0–8	8	<input type="radio"/>
P08.64	ItE detection delay	0.000–60.000s	2.000s	<input type="radio"/>
P08.65	Enabling brake	0–1 0: Disable 1: Enable	0	<input checked="" type="radio"/>
P08.66	Brake feedback mode	0–1 0: Without feedback signal 1: With feedback signal	1	<input checked="" type="radio"/>
P08.67	Brake release frequency	0.20–20.00Hz	1.00Hz	<input type="radio"/>
P08.68	Brake release current	0.0%–P08.75 It is relative to the motor rated current.	0.0%	<input type="radio"/>
P08.69	Delay before brake release	0.000–5.000s	0.300s	<input type="radio"/>
P08.70	Delay after brake release	0.000–5.000s	0.300s	<input type="radio"/>
P08.71	Frequency of brake closing	0.20–20.00Hz	1.00Hz	<input type="radio"/>
P08.72	Delay before brake closing	0.000–5.000s	0.300s	<input type="radio"/>
P08.73	Delay after brake closing	0.000–5.000s	0.300s	<input type="radio"/>
P08.74	Brake feedback exception detection time	0.000–20.000s	3.000s	<input type="radio"/>
P08.75	Electromotive torque upper limit of brake closing	0.0–200.0% It is relative to the motor rated current.	180.0%	<input type="radio"/>
P08.76	Braking torque upper limit of brake closing	0.0–200.0% It is relative to the motor rated current.	180.0	<input type="radio"/>
P08.77	PWM mode selection	0–1 0: SVPWM 1: DPWM	0	<input checked="" type="radio"/>

Function code	Name	Detailed parameter description	Default value	Modify
P08.78	Default voltage and frequency selection	0–3 0: Default voltage is 230V, and default frequency is 50Hz 1: Default voltage is 220 V, and default frequency is 60Hz 2: Default voltage is 400 V, and default frequency is 50Hz 3: Default voltage is 460 V, and default frequency is 60Hz	0	/◎
P08.79–P08.83	Reserved			
P08.84	Debug function	0x0000–0xFFFF	0xFFFF	○

**P09 group—PID control**

Function code	Name	Detailed parameter description	Default value	Modify
P09.00	PID reference source	When frequency command (P00.06, P00.07) is set to 7, or channel of voltage setting (P04.27) is set to 6, the VFD running mode is process PID control. This parameter determines the target reference channel of process PID. 0: Set by P09.01 1: AI1 2: AI2 3: AI3 4: High-speed pulse HDIA 5: Multi-step 6: Modbus/Modbus TCP communication 7: CANopen communication 8: Ethernet communication 9: High-speed pulse HDIB 10: PROFINET/EtherNet IP communication 11: Programmable card 12: Reserved The set target value of process PID is relative value, the set 100% corresponds to 100% of the feedback signal of controlled system. The system operates based on the relative value	0	○

Function code	Name	Detailed parameter description	Default value	Modify
		(0–100.0%)		
P09.01	PID digital setting	You need to set this parameter when P09.00 is set to 0, the reference value of this parameter is the feedback variable of the system. Setting range: -100.0%–100.0%	0.0%	<input type="radio"/>
P09.02	PID feedback source	This parameter is used to select PID feedback channel. 0: AI1 1: AI2 2: AI3 3: High-speed pulse HDIA 4: Modbus/Modbus TCP communication 5: CANopen communication 6: Ethernet communication 7: High-speed pulse HDIB 8: PROFINET/EtherNet IP communication 9: Programmable expansion card 10: Reserved <b>Note:</b> The reference channel and feedback channel cannot overlap; otherwise, PID cannot be controlled effectively.	0	<input type="radio"/>
P09.03	PID output characteristics	0: PID output is positive characteristic: namely, the feedback signal is larger than the PID reference, which requires the VFD output frequency to decrease for PID to reach balance, for example, tension PID control of winding 1: PID output is negative characteristics: namely the feedback signal is larger than PID reference, which requires VFD output frequency to increase for PID to reach balance, for example, tension PID control of unwinding.	0	<input type="radio"/>
P09.04	Proportional gain (Kp)	This function code is suitable for proportional gain P of PID input. It determines the regulation intensity of the whole PID regulator, the larger the value of P, the stronger the regulation intensity. If this parameter is 100, it means when the deviation between PID feedback and reference is 100%, the regulation amplitude of PID regulator (ignoring integral and	1.80	<input type="radio"/>

Function code	Name	Detailed parameter description	Default value	Modify
		differential effect) on output frequency command is the max. frequency (ignoring integral and differential actions). Setting range: 0.00–100.00		
P09.05	Integral time (Ti)	It determines the speed of integral regulation made on the deviation between PID feedback and reference by PID regulator. When the deviation between PID feedback and reference is 100%, the regulation of integral regulator (ignoring integral and differential actions), after undergoing continuous regulation during this time period, can reach Max. output frequency (P00.03) The shorter the integral time, the stronger the regulation intensity. Setting range: 0.00–10.00s	0.90s	○
P09.06	Derivative time (Td)	It determines the intensity of the regulation made on the change rate of deviation between PID feedback and reference by PID regulator. If feedback changes by 100% during this period, the regulation of differential regulator (ignoring integral and differential actions) is Max. output frequency (P00.03) The longer the derivative time, the stronger the regulation intensity. Setting range: 0.00–10.00s	0.00s	○
P09.07	Sampling cycle (T)	It means the sampling cycle of feedback. The regulator operates once during each sampling cycle. The larger the sampling cycle, the slower the response. Setting range: 0.001–1.000s	0.001s	○
P09.08	Limit of PID control deviation	It is the max. allowable deviation of PID system output value relative to closed-loop reference value. Within this limit, PID regulator stops regulation. Set this function code properly to regulate the precision and stability of PID system. Setting range: 0.0–100.0%	0.0%	○

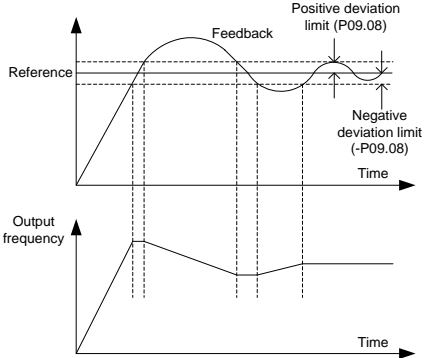
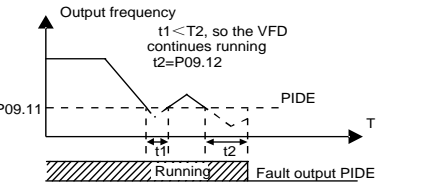
Function code	Name	Detailed parameter description	Default value	Modify
				
P09.09	Upper limit value of PID output	These two function codes are used to set the upper/lower limit value of PID regulator. 100.0% corresponds to Max. output frequency (P00.03) or max. voltage (P04.31)	100.0%	○
P09.10	Lower limit value of PID output		Setting range of P09.09: P09.10–100.0% Setting range of P09.10: -100.0%–P09.09	0.0%
P09.11	Feedback offline detection value	Set PID feedback offline detection value, when the detection value is no more than the feedback	0.0%	○
P09.12	Feedback offline detection time	offline detection value, and the duration exceeds the value set in P09.12, the VFD will report "PID feedback offline fault", and keypad displays PIDE.   Setting range of P09.11: 0.0–100.0% Setting range of P09.12: 0.0–3600.0s	1.0s	○
P09.13	PID control selection	0x0000–0x1111 Ones: 0: Continue integral control after the frequency reaches upper/lower limit 1: Stop integral control after the frequency reaches upper/lower limit Tens: 0: The same with the main reference direction	0x0001	○

Function code	Name	Detailed parameter description	Default value	Modify
		1: Contrary to the main reference direction Hundreds: 0: Limit based on the max. frequency 1: Limit based on A frequency Thousands: 0: A+B frequency, acceleration /deceleration of main reference A frequency source buffering is invalid 1: A+B frequency, acceleration/ deceleration of main reference A frequency source buffering is valid, acceleration and deceleration are determined by P08.04 (acceleration time 4).		
P09.14	Low-frequency proportional gain (Kp)	0.00–100.00 Low-frequency switching point: 5.00Hz high-frequency switching point: 10.00Hz (P09.04 corresponds to high-frequency parameter), and the middle is the linear interpolation between these two points	1.00	<input type="radio"/>
P09.15	Acceleration/ deceleration time of PID command	0.0–1000.0s	0.0s	<input type="radio"/>
P09.16	Filter time of PID output	0.000–10.000s	0.000s	<input type="radio"/>
P09.17	Reserved			
P09.18	Low-frequency integral time	Refer to P09.05. Setting range: 0.00–10.00s	0.90s	<input type="radio"/>
P09.19	Low-frequency differential time	Refer to P09.06. Setting range: 0.00–10.00s	0.00s	<input type="radio"/>
P09.20	Lower frequency point for PID parameter switching	0.00Hz–P09.21	5.00 Hz	<input type="radio"/>
P09.21	Upper frequency point for PID parameter switching	P09.20–P00.03	10.00 Hz	<input type="radio"/>
P09.22–P09.28	Reserved			

**P10 group—Simple PLC and multi-step speed control**

Function code	Name	Detailed parameter description	Default value	Modify
P10.00	Simple PLC mode	0: Stop after running once; the VFD stops automatically after running for one cycle, and it can be started only after receiving running command. 1: Keep running in the final value after running once; The VFD keeps the running frequency and direction of the last section after a single cycle. 2: Cyclic running; the VFD enters the next cycle after completing one cycle until receiving stop command and stops.	0	○
P10.01	Simple PLC memory selection	0: No memory after power down 1: Memory after power down; PLC memories its running stage and running frequency before power down.	0	○
P10.02	Multi-step speed 0	Setting range of the frequency in 0–15 steps are -300.0–300.0%, 100% corresponds to Max. output frequency P00.03. Setting range of the running time in 0–15 steps are 0.0–6553.5s (min), the time unit is determined by P10.37. When simple PLC operation is selected, it is required to set P10.02–P10.33 to determine the running frequency and running time of each step. <b>Note:</b> The symbol of multi-step speed determines the running direction of simple PLC, and the negative value means reverse running.	0.0%	○
P10.03	Running time of step 0		0.0s(min)	○
P10.04	Multi-step speed 1		0.0%	○
P10.05	Running time of step 1		0.0s(min)	○
P10.06	Multi-step speed 2		0.0%	○
P10.07	Running time of step 2		0.0s(min)	○
P10.08	Multi-step speed 3		0.0%	○
P10.09	Running time of step 3		0.0s(min)	○
P10.10	Multi-step speed 4		0.0%	○
P10.11	Running time of step 4		0.0s(min)	○
P10.12	Multi-step speed 5		0.0%	○
P10.13	Running time of step 5		0.0s(min)	○
P10.14	Multi-step speed 6		0.0%	○
P10.15	Running time of step 6		0.0s(min)	○
P10.16	Multi-step speed 7		0.0%	○

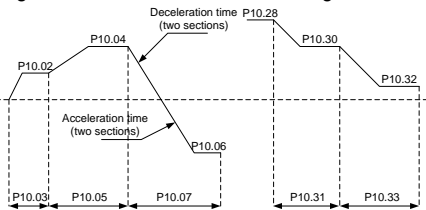

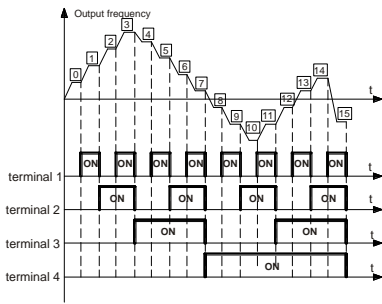

Function code	Name	Detailed parameter description	Default value	Modify																																																						
P10.17	Running time of step 7	<p>multi-step run is also determined by P00.01. The VFD supports the setting of speeds of 16 steps, which are set by combined codes of multi-step terminals 1–4 (set by S terminals, corresponding to function codes P05.01–P05.06) and correspond to multi-step speeds 0–15.</p> 	0.0s(min)	<input type="radio"/>																																																						
P10.18	Multi-step speed 8		0.0%	<input type="radio"/>																																																						
P10.19	Running time of step 8		0.0s(min)	<input type="radio"/>																																																						
P10.20	Multi-step speed 9		0.0%	<input type="radio"/>																																																						
P10.21	Running time of step 9		0.0s(min)	<input type="radio"/>																																																						
P10.22	Multi-step speed 10		0.0%	<input type="radio"/>																																																						
P10.23	Running time of step 10		0.0s(min)	<input type="radio"/>																																																						
P10.24	Multi-step speed 11		0.0%	<input type="radio"/>																																																						
P10.25	Running time of step 11		0.0s(min)	<input type="radio"/>																																																						
P10.26	Multi-step speed 12		When terminal 1, terminal 2, terminal 3 and terminal 4 are OFF, the frequency input mode is set by P00.06 or P00.07. When terminal 1, terminal 2, terminal 3 and terminal 4 are not all OFF, the frequency set by multi-step speed will prevail, and the priority of multi-step setting is higher than that of the keypad, analog, high-speed pulse, PID, and communication settings.	0.0%	<input type="radio"/>																																																					
P10.27	Running time of step 12		The relation between terminals 1–4 are shown in the table below.	0.0s(min)	<input type="radio"/>																																																					
P10.28	Multi-step speed 13			0.0%	<input type="radio"/>																																																					
P10.29	Running time of step 13			0.0s(min)	<input type="radio"/>																																																					
P10.30	Multi-step speed 14			0.0%	<input type="radio"/>																																																					
P10.31	Running time of step 14		<table border="1" data-bbox="380 1093 823 1141"> <tr> <td>Terminal 1</td> <td>OFF</td> <td>ON</td> <td>OFF</td> <td>ON</td> <td>OFF</td> <td>ON</td> <td>OFF</td> <td>ON</td> </tr> <tr> <td>Terminal 2</td> <td>OFF</td> <td>OFF</td> <td>ON</td> <td>ON</td> <td>OFF</td> <td>OFF</td> <td>ON</td> <td>ON</td> </tr> <tr> <td>Terminal 3</td> <td>OFF</td> <td>OFF</td> <td>OFF</td> <td>OFF</td> <td>ON</td> <td>ON</td> <td>ON</td> <td>ON</td> </tr> <tr> <td>Terminal 4</td> <td>OFF</td> <td>OFF</td> <td>OFF</td> <td>OFF</td> <td>OFF</td> <td>OFF</td> <td>OFF</td> <td>OFF</td> </tr> </table>	Terminal 1	OFF	ON	OFF	ON	OFF	ON	OFF	ON	Terminal 2	OFF	OFF	ON	ON	OFF	OFF	ON	ON	Terminal 3	OFF	OFF	OFF	OFF	ON	ON	ON	ON	Terminal 4	OFF	OFF	OFF	OFF	OFF	OFF	OFF	OFF	0.0s(min)	<input type="radio"/>																	
Terminal 1	OFF	ON	OFF	ON	OFF	ON	OFF	ON																																																		
Terminal 2	OFF	OFF	ON	ON	OFF	OFF	ON	ON																																																		
Terminal 3	OFF	OFF	OFF	OFF	ON	ON	ON	ON																																																		
Terminal 4	OFF	OFF	OFF	OFF	OFF	OFF	OFF	OFF																																																		
P10.32	Multi-step speed 15	<table border="1" data-bbox="380 1141 823 1204"> <tr> <td>Terminal 1</td> <td>OFF</td> <td>ON</td> <td>OFF</td> <td>ON</td> <td>OFF</td> <td>ON</td> <td>OFF</td> <td>ON</td> </tr> <tr> <td>Terminal 2</td> <td>OFF</td> <td>OFF</td> <td>ON</td> <td>ON</td> <td>OFF</td> <td>OFF</td> <td>ON</td> <td>ON</td> </tr> <tr> <td>Terminal 3</td> <td>OFF</td> <td>OFF</td> <td>OFF</td> <td>OFF</td> <td>ON</td> <td>ON</td> <td>ON</td> <td>ON</td> </tr> <tr> <td>Terminal 4</td> <td>ON</td> <td>ON</td> <td>ON</td> <td>ON</td> <td>ON</td> <td>ON</td> <td>ON</td> <td>ON</td> </tr> </table>	Terminal 1	OFF	ON	OFF	ON	OFF	ON	OFF	ON	Terminal 2	OFF	OFF	ON	ON	OFF	OFF	ON	ON	Terminal 3	OFF	OFF	OFF	OFF	ON	ON	ON	ON	Terminal 4	ON	ON	ON	ON	ON	ON	ON	ON	0.0%	<input type="radio"/>																		
Terminal 1	OFF	ON	OFF	ON	OFF	ON	OFF	ON																																																		
Terminal 2	OFF	OFF	ON	ON	OFF	OFF	ON	ON																																																		
Terminal 3	OFF	OFF	OFF	OFF	ON	ON	ON	ON																																																		
Terminal 4	ON	ON	ON	ON	ON	ON	ON	ON																																																		
P10.33	Running time of step 15	<table border="1" data-bbox="380 1204 823 1436"> <tr> <td>Step</td> <td>0</td> <td>1</td> <td>2</td> <td>3</td> <td>4</td> <td>5</td> <td>6</td> <td>7</td> </tr> <tr> <td>Terminal 1</td> <td>OFF</td> <td>ON</td> <td>OFF</td> <td>ON</td> <td>OFF</td> <td>ON</td> <td>OFF</td> <td>ON</td> </tr> <tr> <td>Terminal 2</td> <td>OFF</td> <td>OFF</td> <td>ON</td> <td>ON</td> <td>OFF</td> <td>OFF</td> <td>ON</td> <td>ON</td> </tr> <tr> <td>Terminal 3</td> <td>OFF</td> <td>OFF</td> <td>OFF</td> <td>OFF</td> <td>ON</td> <td>ON</td> <td>ON</td> <td>ON</td> </tr> <tr> <td>Terminal 4</td> <td>ON</td> <td>ON</td> <td>ON</td> <td>ON</td> <td>ON</td> <td>ON</td> <td>ON</td> <td>ON</td> </tr> <tr> <td>Step</td> <td>8</td> <td>9</td> <td>10</td> <td>11</td> <td>12</td> <td>13</td> <td>14</td> <td>15</td> </tr> </table>	Step	0	1	2	3	4	5	6	7	Terminal 1	OFF	ON	OFF	ON	OFF	ON	OFF	ON	Terminal 2	OFF	OFF	ON	ON	OFF	OFF	ON	ON	Terminal 3	OFF	OFF	OFF	OFF	ON	ON	ON	ON	Terminal 4	ON	ON	ON	ON	ON	ON	ON	ON	Step	8	9	10	11	12	13	14	15	0.0s(min)	<input type="radio"/>
Step	0	1	2	3	4	5	6	7																																																		
Terminal 1	OFF	ON	OFF	ON	OFF	ON	OFF	ON																																																		
Terminal 2	OFF	OFF	ON	ON	OFF	OFF	ON	ON																																																		
Terminal 3	OFF	OFF	OFF	OFF	ON	ON	ON	ON																																																		
Terminal 4	ON	ON	ON	ON	ON	ON	ON	ON																																																		
Step	8	9	10	11	12	13	14	15																																																		

Function code	Name	Detailed parameter description	Default value	Modify																																																																																																																										
P10.34	Acceleration/deceleration time of steps 0–7 of simple PLC	Detailed illustration is shown in the table below.	0x0000	○																																																																																																																										
P10.35	Acceleration/deceleration time of steps 8–15 of simple PLC	<table border="1" data-bbox="385 240 826 834"> <thead> <tr> <th>Function code</th> <th colspan="2">Binary</th> <th>Step number</th> <th>ACC/DEC time 1</th> <th>ACC/DEC time 2</th> <th>ACC/DEC time 3</th> <th>ACC/DEC time 4</th> </tr> </thead> <tbody> <tr> <td rowspan="8">P10.34</td> <td>BIT1</td> <td>BIT0</td> <td>0</td> <td>00</td> <td>01</td> <td>10</td> <td>11</td> </tr> <tr> <td>BIT3</td> <td>BIT2</td> <td>1</td> <td>00</td> <td>01</td> <td>10</td> <td>11</td> </tr> <tr> <td>BIT5</td> <td>BIT4</td> <td>2</td> <td>00</td> <td>01</td> <td>10</td> <td>11</td> </tr> <tr> <td>BIT7</td> <td>BIT6</td> <td>3</td> <td>00</td> <td>01</td> <td>10</td> <td>11</td> </tr> <tr> <td>BIT9</td> <td>BIT8</td> <td>4</td> <td>00</td> <td>01</td> <td>10</td> <td>11</td> </tr> <tr> <td>BIT11</td> <td>BIT10</td> <td>5</td> <td>00</td> <td>01</td> <td>10</td> <td>11</td> </tr> <tr> <td>BIT13</td> <td>BIT12</td> <td>6</td> <td>00</td> <td>01</td> <td>10</td> <td>11</td> </tr> <tr> <td>BIT15</td> <td>BIT14</td> <td>7</td> <td>00</td> <td>01</td> <td>10</td> <td>11</td> </tr> <tr> <td rowspan="8">P10.35</td> <td>BIT1</td> <td>BIT0</td> <td>8</td> <td>00</td> <td>01</td> <td>10</td> <td>11</td> </tr> <tr> <td>BIT3</td> <td>BIT2</td> <td>9</td> <td>00</td> <td>01</td> <td>10</td> <td>11</td> </tr> <tr> <td>BIT5</td> <td>BIT4</td> <td>10</td> <td>00</td> <td>01</td> <td>10</td> <td>11</td> </tr> <tr> <td>BIT7</td> <td>BIT6</td> <td>11</td> <td>00</td> <td>01</td> <td>10</td> <td>11</td> </tr> <tr> <td>BIT9</td> <td>BIT8</td> <td>12</td> <td>00</td> <td>01</td> <td>10</td> <td>11</td> </tr> <tr> <td>BIT11</td> <td>BIT10</td> <td>13</td> <td>00</td> <td>01</td> <td>10</td> <td>11</td> </tr> <tr> <td>BIT13</td> <td>BIT12</td> <td>14</td> <td>00</td> <td>01</td> <td>10</td> <td>11</td> </tr> <tr> <td>BIT15</td> <td>BIT14</td> <td>15</td> <td>00</td> <td>01</td> <td>10</td> <td>11</td> </tr> </tbody> </table> <p data-bbox="376 842 835 962">Select corresponding acceleration/deceleration time, and then convert 16-bit binary number into hexadecimal number, finally, set corresponding function code.</p> <p data-bbox="376 970 835 1158">Acceleration/deceleration time 1 is set by P00.11 and P00.12; Acceleration/deceleration time 2 is set by P08.00 and P08.01; Acceleration/deceleration time 3 is set by P08.02 and P08.03; Acceleration/deceleration time 4 is set by P08.04 and P08.05. Setting range: 0x0000–0xFFFF</p>	Function code	Binary		Step number	ACC/DEC time 1	ACC/DEC time 2	ACC/DEC time 3	ACC/DEC time 4	P10.34	BIT1	BIT0	0	00	01	10	11	BIT3	BIT2	1	00	01	10	11	BIT5	BIT4	2	00	01	10	11	BIT7	BIT6	3	00	01	10	11	BIT9	BIT8	4	00	01	10	11	BIT11	BIT10	5	00	01	10	11	BIT13	BIT12	6	00	01	10	11	BIT15	BIT14	7	00	01	10	11	P10.35	BIT1	BIT0	8	00	01	10	11	BIT3	BIT2	9	00	01	10	11	BIT5	BIT4	10	00	01	10	11	BIT7	BIT6	11	00	01	10	11	BIT9	BIT8	12	00	01	10	11	BIT11	BIT10	13	00	01	10	11	BIT13	BIT12	14	00	01	10	11	BIT15	BIT14	15	00	01	10	11	0x0000	○
Function code	Binary		Step number	ACC/DEC time 1	ACC/DEC time 2	ACC/DEC time 3	ACC/DEC time 4																																																																																																																							
P10.34	BIT1	BIT0	0	00	01	10	11																																																																																																																							
	BIT3	BIT2	1	00	01	10	11																																																																																																																							
	BIT5	BIT4	2	00	01	10	11																																																																																																																							
	BIT7	BIT6	3	00	01	10	11																																																																																																																							
	BIT9	BIT8	4	00	01	10	11																																																																																																																							
	BIT11	BIT10	5	00	01	10	11																																																																																																																							
	BIT13	BIT12	6	00	01	10	11																																																																																																																							
	BIT15	BIT14	7	00	01	10	11																																																																																																																							
P10.35	BIT1	BIT0	8	00	01	10	11																																																																																																																							
	BIT3	BIT2	9	00	01	10	11																																																																																																																							
	BIT5	BIT4	10	00	01	10	11																																																																																																																							
	BIT7	BIT6	11	00	01	10	11																																																																																																																							
	BIT9	BIT8	12	00	01	10	11																																																																																																																							
	BIT11	BIT10	13	00	01	10	11																																																																																																																							
	BIT13	BIT12	14	00	01	10	11																																																																																																																							
	BIT15	BIT14	15	00	01	10	11																																																																																																																							
P10.36	PLC restart mode	<p data-bbox="376 1166 835 1286">0: Restart from step 0 in multi-step speed running, namely if the VFD stops during running (caused by stop command, fault or power down), it will run from the first step after restart.</p> <p data-bbox="376 1294 835 1444">1: Continue running from the step frequency when interruption occurred, namely if the VFD stops during running (caused by stop command or fault), it will record the running time of current step, and enters this step automatically after restart, then</p>	0	◎																																																																																																																										

Function code	Name	Detailed parameter description	Default value	Modify
		continue running at the frequency defined by this step in the remaining time.		
P10.37	Multi-step time unit	0: s; The running time of each step is counted in seconds. 1: min; The running time of each step is counted in minutes.	0	☉

**P11 group—Protection parameters**

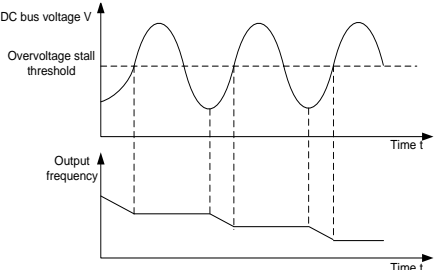
Function code	Name	Detailed parameter description	Default value	Modify
P11.00	Phase-loss protection	0x000–0x111 Ones: 0: Disable software input phase loss protection 1: Enable software input phase loss protection Tens: 0: Disable output phase loss protection 1: Enable output phase loss protection Hundreds: 0: Disable hardware input phase loss protection 1: Enable hardware input phase loss protection <b>Note:</b> Except that the default value for UMI-B7 575V is 0x011, the default values for other models are 0x110.	0x110	○
P11.01	Frequency-drop at transient power down	0: Disable 1: Enable	0	○
P11.02	Energy braking in standby state	0: Enable 1: Disable	0	☉
P11.03	Overvoltage stall protection	0: Disable 1: Enable 	1	○

Function code	Name	Detailed parameter description	Default value	Modify
P11.04	Overvoltage stall protection voltage	120–150% (standard bus voltage) (220V)	120%	○
		120–150% (standard bus voltage) (460V)	120%	
		120–150% (standard bus voltage) (575V)	120%	
P11.05	Current-limit selection	<p>During accelerated running, as the load is too large, the actual acceleration rate of motor is lower than that of output frequency, if no measures are taken, the VFD may trip due to overcurrent during acceleration.</p> <p>0x00–0x11                      Ones: Current-limit action selection                      0: Invalid                      1: Always valid</p> <p>Tens: Hardware current-limit overload alarm selection                      0: Valid                      1: Invalid</p>	01	◎
P11.06	Automatic current-limit level	Current-limit protection function detects output current during running, and compares it with the current-limit level defined by P11.06, if it exceeds the current-limit level, the VFD will run at stable frequency during accelerated running, or run in decreased frequency during constant-speed running; if it exceeds the current-limit level continuously, the VFD output frequency will drop continuously until reaching lower limit frequency. When the output current is detected to be lower than the current-limit level again, it will continue accelerated running.	160.0%	◎
P11.07	Frequency-drop rate during current limit	<p>Setting range of P11.06: 50.0–200.0% (of the rated VFD output current)</p>	10.00 Hz/s	◎

Function code	Name	Detailed parameter description	Default value	Modify
		Setting range of P11.07: 0.00–50.00Hz/s		
P11.08	VFD or motor overload/underload pre-alarm	0x0000–0x1134 Ones place: 0: Motor overload/underload pre-alarm, relative to rated motor current 1: VFD overload/underload pre-alarm, relative to rated VFD output current 2: VFD output torque overload/underload pre-alarm, relative to rated motor torque 3: Motor overload/underload pre-alarm. The overload is relative to the motor rated current; while the underload is relative to the motor rated power. 4: VFD overload/underload pre-alarm. The overload is relative to the VFD rated current; while the underload is relative to the VFD rated power. Tens place: 0: The VFD continues running after overload/underload alarm. 1: The VFD continues running after underload alarm, and stops running after overload fault. 2: The VFD continues running after overload alarm, and stops running after underload fault. 3: The VFD stops running after overload/underload fault. Hundreds place: 0: Always detect 1: Detect during constant-speed running Thousands place: VFD overload current reference selection 0: Related to current calibration coefficient 1: Unrelated to current calibration coefficient	0x0000	○
P11.09	Overload pre-alarm detection level	If the VFD or motor output current is larger than the overload pre-alarm detection level (P11.09), and the duration exceeds the overload pre-alarm detection time (P11.10), overload pre-alarm signal will be outputted.	G model: 150% P model: 120%	○
P11.10	Overload pre-alarm detection time		1.0s	○

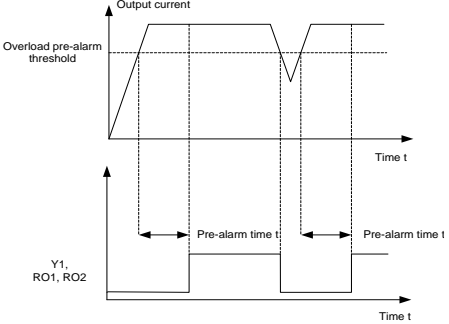
Function code	Name	Detailed parameter description	Default value	Modify
		 <p>Setting range of P11.09: P11.11–200% (relative value determined by the ones place of P11.08) Setting range of P11.10: 0.1–3600.0s</p>		
P11.11	Underload pre-alarm detection level	Underload pre-alarm signal will be outputted if the output current of the VFD or motor is lower than underload pre-alarm detection level (P11.11), and	50%	○
P11.12	Underload pre-alarm detection time	the duration exceeds underload pre-alarm detection time (P11.12). Setting range of P11.11: 0–P11.09 (relative value determined by the ones place of P11.08) Setting range of P11.12: 0.1–3600.0s	1.0s	○
P11.13	Fault output terminal action during fault	Used to set the action of fault output terminals during undervoltage and fault reset. 0x00–0x11 Ones: 0: Act during undervoltage fault 1: Do not act during undervoltage fault Tens: 0: Act during fault reset 1: Do not act during fault reset	0x00	○
P11.14	Speed deviation detection value	0.0–50.0% Used to set the speed deviation detection value.	10.0%	○
P11.15	Speed deviation detection time	Used to set the speed deviation detection time. <b>Note:</b> Speed deviation protection will be invalid if P11.15 is set to 0.0.	2.0s	○

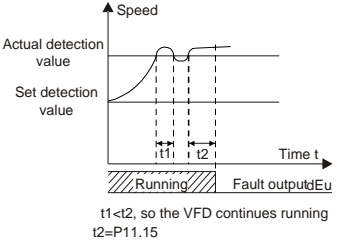
Function code	Name	Detailed parameter description	Default value	Modify
		 <p>Setting range: 0.0–10.0s</p>		
P11.16	Automatic frequency-reduction during voltage drop	0–1 0: Invalid 1: Valid	0	<input type="radio"/>
P11.17	Proportional coefficient of voltage regulator during undervoltage stall	Used to set the proportional coefficient of the bus voltage regulator during undervoltage stall. Setting range: 0–1000	100	<input type="radio"/>
P11.18	Integral coefficient of voltage regulator during undervoltage stall	Used to set the integral coefficient of the bus voltage regulator during undervoltage stall. Setting range: 0–1000	40	<input type="radio"/>
P11.19	Proportional coefficient of current regulator during undervoltage stall	Used to set the proportional coefficient of the active current regulator during undervoltage stall. Setting range: 0–1000	25	<input type="radio"/>
P11.20	Integral coefficient of current regulator during undervoltage stall	Used to set the integral coefficient of the active current regulator during undervoltage stall. Setting range: 0–2000	150	<input type="radio"/>
P11.21	Proportional coefficient of voltage regulator during overvoltage stall	Used to set the proportional coefficient of the bus voltage regulator during overvoltage stall. Setting range: 0–1000	60	<input type="radio"/>
P11.22	Integral	Used to set the integral coefficient of the bus	10	<input type="radio"/>

Function code	Name	Detailed parameter description	Default value	Modify
	coefficient of voltage regulator during overvoltage stall	voltage regulator during overvoltage stall. Setting range: 0–1000		
P11.23	Proportional coefficient of current regulator during overvoltage stall	Used to set the proportional coefficient of the active current regulator during overvoltage stall. Setting range: 0–1000	60	<input type="radio"/>
P11.24	Integral coefficient of current regulator during overvoltage stall	Used to set the integral coefficient of the active current regulator during overvoltage stall. Setting range: 0–2000	250	<input type="radio"/>
P11.25	Enable VFD overload integral	0: Disabled 1: Enabled When this parameter is set to 0, the overload timing value is reset to zero after the VFD is stopped. In this case, the determination of VFD overload takes more time, and therefore the effective protection over the VFD is weakened. When this parameter is set to 1, the overload timing value is not reset, and the overload timing value is accumulative. In this case, the determination of VFD overload takes less time, and therefore the protection over the VFD can be performed more quickly.	0	<input checked="" type="radio"/>
P11.26	Reserved			
P11.27	VF vibration control method	0x00–0x11 Ones place: 0: Method 1 1: Method 2 Tens place: 0: Reserved 1: Reserved	0x00	<input checked="" type="radio"/>
P11.28	SPO switch-on detection delay time	0.0–60.0(s) Note: The SPO detection is started only after the VFD runs for the delay time P11.28 to avoid false	5.0	<input type="radio"/>



Function code	Name	Detailed parameter description	Default value	Modify
		alarms caused by the unstable frequency.		
P11.29	SPO unbalance factor	0–10	6	<input type="radio"/>
P11.30	Reserved			
P11.31	Fault severity group 1	0x0000–0x3333	0x0000	<input type="radio"/>
P11.32	Fault severity group 2	Thousands place/Hundreds place/Tens place/Ones place: 0: Report the fault	0x0000	<input type="radio"/>
P11.33	Fault severity group 3	1: Report the fault after deceleration to stop	0x0000	<input type="radio"/>
P11.34	Fault severity group 4	2: Pre-alarm, with the action executed according to P11.51	0x0000	<input type="radio"/>
P11.35	Fault severity group 5	3: Screen out the fault	0x0000	<input type="radio"/>
P11.36	Fault severity group 6	Note: Different fault actions are taken for different fault severities. The first 10 faults are not grouped by severity, but each four of the subsequent faults are grouped by severity in ascending order from right to left in hexadecimal format, that is, from the ones place to the thousands place (for example, the ones place of fault severity group 1 corresponds to fault 11).	0x0000	<input type="radio"/>
P11.37	Fault severity group 7		0x0000	<input type="radio"/>
P11.38	Fault severity group 8		0x0000	<input type="radio"/>
P11.39	Fault severity group 9	Group 1: Faults 11–14 (OL1, OL2, SPI, SPO)	0x0000	<input type="radio"/>
P11.40	Fault severity group 10	Group 2: Faults 15–18 (OH1, OH2, EF, CE)	0x0000	<input type="radio"/>
P11.41	Fault severity group 11	Group 3: Faults 19–22 (ItE, tE, EEP, PIDE)	0x0000	<input type="radio"/>
P11.42	Fault severity group 12	Group 4: Faults 23–26 (bCE, END, OL3, PCE)	0x0000	<input type="radio"/>
P11.43	Fault severity group 13	Group 5: Faults 27–30 (UPE, DNE, E-DP, E-NET)	0x0000	<input type="radio"/>
P11.44	Fault severity group 14	Group 6: Faults 31–34 (E-CAN, ETH1, ETH2, dEu)	0x0000	<input type="radio"/>
P11.45	Fault severity group 15	Group 7: Faults 35–38 (STo, LL, ENC1o, ENC1d)	0x0000	<input type="radio"/>
P11.46	Fault severity group 16	Group 8: Faults 39–42 (ENC1Z, STO, STL1, STL2)	0x0000	<input type="radio"/>
P11.47	Fault severity group 17	Group 9: Faults 43–46 (STL3, CrCE, P-E1, P-E2)	0x0000	<input type="radio"/>
		Group 10: Faults 47–50 (P-E3, P-E4, P-E5, P-E6)	0x0000	<input type="radio"/>
		Group 11: Faults 51–54 (P-E7, P-E8, P-E9, P-E10)	0x0000	<input type="radio"/>
		Group 12: Faults 55–58 (E-Err, ENCU, E-PN, SECAN)	0x0000	<input type="radio"/>
		Group 13: Faults 59–62 (OT, F1-Er, F2-Er, F3-Er)	0x0000	<input type="radio"/>
		Group 14: Faults 63–66 (C1-Er, C2-Er, C3-Er, E-CAT)	0x0000	<input type="radio"/>
		Group 15: Faults 67–70 (E-BAC, E-DEV, S-Err,	0x0000	<input type="radio"/>

Function code	Name	Detailed parameter description	Default value	Modify
P11.48	Fault severity group 18	OtE1	0x0000	<input type="radio"/>
P11.49	Fault severity group 19	Group 16: Faults 71–75 (OtE2, E-EIP, E-PAO, E-AI1)	0x0000	<input type="radio"/>
P11.50	Fault severity group 20	Group 17: Faults 75–78 (E-AI2, E-AI3, E-brF, E-StK) Group 18: Faults 79–82 (E-Lst, Reserved, Reserved, Reserved) Group 19: Faults 83–86 (Reserved, Reserved, Reserved, Reserved) Group 20: Faults 87–90 (Reserved, Reserved, Reserved, Reserved)	0x0000	<input type="radio"/>
P11.51	Action for fault pre-alarm	0–4 0: Run at the set frequency 1: Run at the output frequency at the time of fault 2: Run at the frequency upper limit 3: Run at the frequency lower limit 4: Run at the frequency reserved for exception	0	<input type="radio"/>
P11.52	Frequency reserved for exception	0.00Hz–P00.03	0.00Hz	<input type="radio"/>
P11.53	Fire mode function	0–2 0: Invalid 1: Fire mode 1 2: Fire mode 2 When P11.53=0, the fire mode is invalid, and the normal running mode is used. In this case, the VFD stops when encountering a fault. When the fire mode function is valid, the VFD runs at the speed specified by P11.54. When fire mode 1 is selected, the VFD always runs except when the VFD has been damaged. When fire mode 2 is selected, the VFD always runs, but the VFD stops when encountering OUT1, OUT2, OUT3, OC1, OC2, OC3, OV1, OV2, OV3, or SPO. Note: Terminal control must be used for a fire mode. When the fire mode has lasted 5 minutes, it is reset, and no warranty of repair is processed.	0	<input checked="" type="radio"/>

Function code	Name	Detailed parameter description	Default value	Modify
P11.54	Running frequency in fire mode	0.00Hz–P00.03 (Max. output frequency)	50.00Hz	○
P11.55	Fire mode flag	0–1 Note: When the fire mode has lasted 5 minutes, it is reset, and no warranty of repair is processed.	0	●
P11.56	Software detection method for input phase loss	0: Using a sine-wave orthogonal function for detection at 100Hz frequency component 1: Using a square-wave orthogonal function for detection at 100Hz frequency component	1	○
P11.57	Software detection limited value for input phase loss	Peak value of bus voltage fluctuation at 100Hz frequency component 0–200.0V	40.0V	○
P11.58	Software detection time for input phase loss	0–20.0s	2.0s	○
P11.59	Exciting current limit in flux weakening	0.0–100.0%	100.0%	○
P11.60	Detection time of stalling in V/F control	0.000–60.000s	5.000	◎
P11.61	Detection time of out-of-step in V/F control	0.000–60.000s <b>Note:</b> Setting it to 0.000s indicates no detection.	5.000	◎

**P12 group—Parameters of motor 2**

Function code	Name	Detailed parameter description	Default value	Modify
P12.00	Type of motor 2	0: Asynchronous motor 1: Synchronous motor	0	◎
P12.01	Rated power of asynchronous motor 2	0.1–3000.0kW	Depends on model	◎
P12.02	Rated frequency of asynchronous motor 2	0.01Hz–P00.03 (Max. output frequency)	60.00Hz	◎
P12.03	Rated speed of	1–60000rpm	1700rpm	◎

Function code	Name	Detailed parameter description	Default value	Modify
	asynchronous motor 2			
P12.04	Rated voltage of asynchronous motor 2	0–1200V	Depends on model	☉
P12.05	Rated current of asynchronous motor 2	0.8–6000.0A	Depends on model	☉
P12.06	Stator resistance of asynchronous motor 2	0.001–65.535Ω	Depends on model	○
P12.07	Rotor resistance of asynchronous motor 2	0.001–65.535Ω	Depends on model	○
P12.08	Leakage inductance of asynchronous motor 2	0.1–6553.5mH	Depends on model	○
P12.09	Mutual inductance of asynchronous motor 2	0.1–6553.5mH	Depends on model	○
P12.10	No-load current of asynchronous motor 2	0.1–6553.5A	Depends on model	○
P12.11	Magnetic saturation coefficient 1 of iron core of asynchronous motor 2	0.0–100.0%	80%	○
P12.12	Magnetic saturation coefficient 2 of iron core of asynchronous motor 2	0.0–100.0%	68%	○
P12.13	Magnetic	0.0–100.0%	57%	○

Function code	Name	Detailed parameter description	Default value	Modify
	saturation coefficient 3 of iron core of asynchronous motor 2			
P12.14	Magnetic saturation coefficient 4 of iron core of asynchronous motor 2	0.0–100.0%	40%	<input type="radio"/>
P12.15	Rated power of synchronous motor 2	0.1–3000.0kW	Depends on model	<input checked="" type="radio"/>
P12.16	Rated frequency of synchronous motor 2	0.01Hz–P00.03 (Max. output frequency)	60.00Hz	<input checked="" type="radio"/>
P12.17	Number of pole pairs of synchronous motor 2	1–128	2	<input checked="" type="radio"/>
P12.18	Rated voltage of synchronous motor 2	0–1200V	Depends on model	<input checked="" type="radio"/>
P12.19	Rated voltage of synchronous motor 2	0.8–6000.0A	Depends on model	<input checked="" type="radio"/>
P12.20	Stator resistance of synchronous motor 2	0.001–65.535Ω	Depends on model	<input type="radio"/>
P12.21	Direct-axis inductance of synchronous motor 2	0.01–655.35mH	Depends on model	<input type="radio"/>
P12.22	Quadrature-axis inductance of synchronous motor 2	0.01–655.35mH	Depends on model	<input type="radio"/>

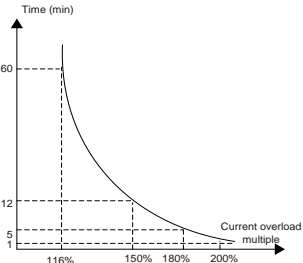
Function code	Name	Detailed parameter description	Default value	Modify
P12.23	Counter-emf constant of synchronous motor 2	0–10000V	300V	<input type="radio"/>
P12.24	Initial pole position of synchronous motor 2	0x0000–0xFFFF	0x0000	<input checked="" type="radio"/>
P12.25	Identification current of synchronous motor 2	0%–50% (of motor rated current)	10%	<input checked="" type="radio"/>
P12.26	Overload protection of motor 2	0: No protection 1: Common motor (with low-speed compensation) 2: Frequency-variable motor (without low-speed compensation)	2	<input checked="" type="radio"/>
P12.27	Overload protection coefficient of motor 2	<p>Motor overload multiples <math>M = I_{out}/(I_n \times K)</math>  <math>I_n</math> is rated motor current, <math>I_{out}</math> is VFD output current, <math>K</math> is motor overload protection coefficient.                      The smaller the <math>K</math>, the larger the value of <math>M</math>, the easier the protection.</p> <p>When <math>M=116\%</math>, protection is performed after motor overload lasts for 1 hour; when <math>M=150\%</math>, protection is performed after motor overload lasts for 12 minutes; when <math>M=180\%</math>, protection is performed after motor overload lasts for 5 minutes; when <math>M=200\%</math>, protection is performed after motor overload lasts for 60 seconds; and when <math>M \geq 400\%</math>, protection is performed immediately.</p>  <p>Setting range: 20.0%–120.0%</p>	100.0%	<input type="radio"/>

Function code	Name	Detailed parameter description	Default value	Modify
P12.28	Power display calibration coefficient of motor 2	0.00–3.00	1.00	<input type="radio"/>
P12.29	Parameter display of motor 2	0: Display based on the motor type; under this mode, only parameters related to current motor type will be displayed. 1: Display all; under this mode, all the parameters will be displayed.	0	<input type="radio"/>
P12.30	System inertia of motor 2	0–30.000kgm <sup>2</sup>	0.000	<input type="radio"/>
P12.31– P12.32	Reserved			

**P13 group—Control parameters of synchronous motor**

Function code	Name	Detailed parameter description	Default value	Modify
P13.00	Reduction rate of the pull-in current of synchronous motor	Used to set the reduction rate of the input reactive current. When the active current of the synchronous motor increases to some extent, the input reactive current can be reduced to improve the power factor of the motor. Setting range: 0.0%–100.0% (of the rated current of the motor)	80.0%	<input type="radio"/>
P13.01	Initial pole detection mode	0: No detection 1: High-frequency current injection 2: Pulse superimposition	0	<input checked="" type="radio"/>
P13.02	Pull-in current 1	Pull-in current is the pole position orientation current; pull-in current 1 is valid within the lower limit of pull-in current switchover frequency threshold. If you need to increase the starting torque, increase the value of this function code properly. Setting range: 0.0%–100.0% (of the motor rated current)	20.0%	<input type="radio"/>
P13.03	Pull-in current 2	Pull-in current is the pole position orientation current; pull-in current 2 is valid within the upper limit of pull-in current switchover frequency threshold, and you do not need to change pull-in	10.0%	<input type="radio"/>

Function code	Name	Detailed parameter description	Default value	Modify
		current 2 under common situations. Setting range: 0.0%–100.0% (of the motor rated current)		
P13.04	Switchover frequency of input current	0.0–200.0% (of the motor rated frequency)	20.0%	○
P13.05	High-frequency superposition frequency	200Hz–1000Hz	500Hz	◎
P13.06	Pulse current setting	Used to set the pulse current threshold when the initial magnetic pole position is detected in the pulse mode. The value is a percentage relative to the rated current of the motor. Setting range: 0.0–300.0% (of the rated voltage of the motor)	100.0%	◎
P13.07	Control parameter 0	0.0–400.0	0.0	○
P13.08	Control parameter 1	0–0xFFFF	0	○
P13.09	Frequency threshold of phase-lock loop switch-in	This parameter is used to set the frequency threshold for enabling the counter-electromotive force phase-locked loop in SVC 0. When the running frequency is lower than the value of this parameter, the phase-locked loop is disabled; and when the running frequency is higher than that, the phase-locked loop is enabled. Setting range: 0.00–655.35	50.00	○
P13.10	Initial compensation angle of synchronous motor	0.0–359.9°	0.0°	○
P13.11	Maladjustment detection time	Used to adjust the responsiveness of anti-maladjustment function. If the load inertia is large, increase the value of this parameter properly, however, the responsiveness may slow down accordingly. Setting range: 0.0–10.0s	0.5s	○



Function code	Name	Detailed parameter description	Default value	Modify
P13.12	High-frequency compensation coefficient of synchronous motor	This parameter is valid when the motor speed exceeds the rated speed. If motor oscillation occurred, adjust this parameter properly. Setting range: 0.0–100.0%	0.0%	<input type="radio"/>
P13.13	High-frequency injection current	0–300.0% (of the rated VFD output current)	20.0%	<input checked="" type="radio"/>

**P14 group—Serial communication function**

Function code	Name	Detailed parameter description	Default value	Modify
P14.00	Local communication address	Setting range: 1–247 When the master is writing frames, and the slave communication address is set to 0, it is the broadcast communication address, and all the slaves on the Modbus bus will accept this frame, but the slave never responds. Local communication address is unique in the communication network, which is the basis for point-to-point communication between the upper computer and the VFD. <b>Note:</b> The slave address cannot be set to 0.	1	<input type="radio"/>
P14.01	Communication baud rate setting	Used to set the data transmission speed between upper computer and the VFD. 0: 1200bps 1: 2400bps 2: 4800bps 3: 9600bps 4: 19200bps 5: 38400bps 6: 57600bps 7: 115200bps <b>Note:</b> Baud rate of the upper computer must be the same with the VFD; otherwise, communication cannot be performed. The larger the baud rate, the faster the communication speed.	4	<input type="radio"/>
P14.02	Data bit check setting	The data format of upper computer must be the same with the VFD; otherwise, communication cannot be performed.	1	<input type="radio"/>

Function code	Name	Detailed parameter description	Default value	Modify
		0: No parity check (N, 8, 1) for RTU 1: Even parity (E, 8, 1) for RTU 2: Odd parity (O, 8, 1) for RTU 3: No parity check (N, 8, 2) for RTU 4: Even parity (E, 8, 2) for RTU 5: Odd parity (O, 8, 2) for RTU		
P14.03	Communication response delay	0–200ms It refers to the time interval from when the data is received by the VFD to the moment when the data is sent to the upper computer. If the response delay is less than the system processing time, the response delay will be subject to system processing time; if the response delay is longer than the system processing time, data will be sent to the upper computer at a delay after data process is done by system.	5	○
P14.04	Communication timeout period	0.0 (invalid)–60.0s This parameter will be invalid if it is set to 0.0; When it is set to a non-zero value, if the time interval between current communication and the next communication exceeds the communication timeout period, the system will report "485 communication fault" (CE). Under common situations, it is set to 0.0. In systems which have continuous communication, you can monitor the communication condition by setting this parameter.	0.0s	○
P14.05	Transmission error processing	0: Alarm and coast to stop 1: Do not alarm and continue running 2: Do not alarm and stop as per the stop mode (under communication control mode only) 3: Do not alarm and stop as per the stop mode (under all control modes)	0	○
P14.06	Modbus communication processing action	0x000–0x111 Ones: Write operation response selection 0: Write operation has response 1: Write operation has no response Tens: Communication password protection selection	0x000	○

Function code	Name	Detailed parameter description	Default value	Modify
		0: Communication password protection is invalid 1: Communication password protection is valid Hundreds: User-defined address validity 0: User-defined addresses of P14.07 and P14.08 are invalid. 1: User-defined addresses of P14.07 and P14.08 are valid.		
P14.07	User-defined running command address	0x0000–0xFFFF	0x2000	<input type="radio"/>
P14.08	User-defined frequency setting address	0x0000–0xFFFF	0x2001	<input type="radio"/>
P14.09	Modbus TCP communication timeout time	0.0–60.0s	5.0	<input type="radio"/>
P14.10	Enabling program upgrade through RS485	0–1 0: Disable 1: Enable	0	<input checked="" type="radio"/>
P14.11	Bootloader software version	0.00–655.35	0.00	<input checked="" type="radio"/>
P14.12	Displaying no upgrade bootloader fault	0–1 0: Display 1: Do not display	0	<input type="radio"/>
P14.13–P14.47	Reserved			
P14.48	Channel selection for mapping between PZDs and function codes	0x00–0x12 Ones place: Channel for mapping function codes to PZDs 0: Reserved 1: Group P15 2: Group P16 Tens place: Save function at power failure 0: Disable 1: Enable	0x12	<input type="radio"/>
P14.49	Mapped function code of received PZD2	0x0000–0xFFFF	0x0000	<input type="radio"/>
P14.50	Mapped function code of received	0x0000–0xFFFF	0x0000	<input type="radio"/>

Function code	Name	Detailed parameter description	Default value	Modify
	PZD3			
P14.51	Mapped function code of received PZD4	0x0000–0xFFFF	0x0000	<input type="radio"/>
P14.52	Mapped function code of received PZD5	0x0000–0xFFFF	0x0000	<input type="radio"/>
P14.53	Mapped function code of received PZD6	0x0000–0xFFFF	0x0000	<input type="radio"/>
P14.54	Mapped function code of received PZD7	0x0000–0xFFFF	0x0000	<input type="radio"/>
P14.55	Mapped function code of received PZD8	0x0000–0xFFFF	0x0000	<input type="radio"/>
P14.56	Mapped function code of received PZD9	0x0000–0xFFFF	0x0000	<input type="radio"/>
P14.57	Mapped function code of received PZD10	0x0000–0xFFFF	0x0000	<input type="radio"/>
P14.58	Mapped function code of received PZD11	0x0000–0xFFFF	0x0000	<input type="radio"/>
P14.59	Mapped function code of received PZD12	0x0000–0xFFFF	0x0000	<input type="radio"/>
P14.60	Mapped function code of sent PZD2	0x0000–0xFFFF	0x0000	<input type="radio"/>
P14.61	Mapped function code of sent PZD3	0x0000–0xFFFF	0x0000	<input type="radio"/>
P14.62	Mapped function code of sent PZD4	0x0000–0xFFFF	0x0000	<input type="radio"/>
P14.63	Mapped function	0x0000–0xFFFF	0x0000	<input type="radio"/>

Function code	Name	Detailed parameter description	Default value	Modify
	code of sent PZD5			
P14.64	Mapped function code of sent PZD6	0x0000–0xFFFF	0x0000	<input type="radio"/>
P14.65	Mapped function code of sent PZD7	0x0000–0xFFFF	0x0000	<input type="radio"/>
P14.66	Mapped function code of sent PZD8	0x0000–0xFFFF	0x0000	<input type="radio"/>
P14.67	Mapped function code of sent PZD9	0x0000–0xFFFF	0x0000	<input type="radio"/>
P14.68	Mapped function code of sent PZD10	0x0000–0xFFFF	0x0000	<input type="radio"/>
P14.69	Mapped function code of sent PZD11	0x0000–0xFFFF	0x0000	<input type="radio"/>
P14.70	Mapped function code of sent PZD12	0x0000–0xFFFF	0x0000	<input type="radio"/>

**P15 group—Functions of communication expansion card 1**

Function code	Name	Detailed parameter description	Default value	Modify
P15.00	Reserved			
P15.01	Module address	0–127	2	<input checked="" type="radio"/>
P15.02	Received PZD2	0–31	0	<input type="radio"/>
P15.03	Received PZD3	0: Invalid	0	<input type="radio"/>
P15.04	Received PZD4	1: Set frequency (0–Fmax. Unit: 0.01Hz)	0	<input type="radio"/>
P15.05	Received PZD5	2: PID reference (-1000–1000, in which 1000 corresponds to 100.0%)	0	<input type="radio"/>
P15.06	Received PZD6	3: PID feedback (-1000–1000, in which 1000 corresponds to 100.0%)	0	<input type="radio"/>
P15.07	Received PZD7		0	<input type="radio"/>
P15.08	Received PZD8	4: Torque setting (-3000–+3000, in which 1000 corresponds to 100.0% of the motor rated current)	0	<input type="radio"/>
P15.09	Received PZD9		0	<input type="radio"/>

Function code	Name	Detailed parameter description	Default value	Modify
P15.10	Received PZD10	5: Setting of the upper limit of forward running frequency (0–Fmax. Unit: 0.01 Hz)	0	<input type="radio"/>
P15.11	Received PZD11	6: Setting of the upper limit of reverse running frequency (0–Fmax. Unit: 0.01 Hz)	0	<input type="radio"/>
P15.12	Received PZD12	7: Upper limit of electromotive torque (0–3000, in which 1000 corresponds to 100.0% of the motor rated current) 8: Upper limit of braking torque (0–3000, in which 1000 corresponds to 100% of the motor rated current) 9: Virtual input terminal command (Range: 0x000–0x3FF, corresponding to S8/S7/S6/S5/HDIB/HDIA/S4/S3/S2/S1) 10: Virtual output terminal command (Range: 0x00–0x0F, corresponding to RO2/RO1/HDO/Y1) 11: Voltage setting (special for V/F separation) (0–1000, in which 1000 corresponds to 100% of the motor rated voltage) 12: AO1 output setting 1 (-1000→+1000, in which 1000 corresponds to 100.0%) 13: AO2 output setting 2 (-1000–1000, in which 1000 corresponds to 100.0%) 14: MSB of position reference (signed) 15: LSB of position reference (unsigned) 16: MSB of position feedback (signed) 17: LSB of position feedback (unsigned) 18: Position feedback setting flag (position feedback can be set only after this flag is set to 1 and then to 0) 19: Function parameter mapping (PZD2–PZD12 correspond to P14.49–P14.59) 20–31: Reserved	0	<input type="radio"/>
P15.13	Sent PZD2	0–47	0	<input type="radio"/>
P15.14	Sent PZD3	0: Invalid	0	<input type="radio"/>
P15.15	Sent PZD4	1: Running frequency (x100, Hz)	0	<input type="radio"/>
P15.16	Sent PZD5	2: Set frequency (x100, Hz)	0	<input type="radio"/>
P15.17	Sent PZD6	3: Bus voltage (x10, V)	0	<input type="radio"/>
P15.18	Sent PZD7	4: Output voltage (x1, V)	0	<input type="radio"/>
		5: Output current (x10, A)	0	<input type="radio"/>

Function code	Name	Detailed parameter description	Default value	Modify
P15.19	Sent PZD8	6: Actual output torque (x10, %)	0	<input type="radio"/>
P15.20	Sent PZD9	7: Actual output power (x10, %)	0	<input type="radio"/>
P15.21	Sent PZD10	8: Rotation speed of running (x1, rpm)	0	<input type="radio"/>
P15.22	Sent PZD11	9: Linear speed of running (x1, m/s)	0	<input type="radio"/>
P15.23	Sent PZD12	10: Ramp reference frequency 11: Fault code 12: AI1 input (x100, V) 13: AI2 input (x100, V) 14: AI3 input (x100, V) 15: HDIA frequency value (x1000, kHz) 16: Terminal input status 17: Terminal output status 18: PID reference (x10, %) 19: PID feedback (x10, %) 20: Motor rated torque 21: MSB of position reference (signed) 22: LSB of position reference (unsigned) 23: MSB of position feedback (signed) 24: LSB of position feedback (unsigned) 25: Status word 26: HDIB frequency value (x1000, kHz) 27: MSB of PG card pulse feedback 28: LSB of PG card pulse feedback 29: MSB of PG card pulse reference 30: LSB of PG card pulse reference 31: Function parameter mapping (PZD2–PZD12 correspond to P14.60–P14.70) 32: Status word 3 33–47: Reserved	0	<input type="radio"/>
P15.24	Reserved			
P15.25	DP communication timeout time	0.0 (invalid)–60.0s	5.0	<input type="radio"/>
P15.26	CANopen communication timeout time	0.0 (invalid)–60.0s	5.0	<input type="radio"/>
P15.27	CANopen communication baud rate	0–7 0: 1000kbps 1: 800kbps	3	<input checked="" type="radio"/>

Function code	Name	Detailed parameter description	Default value	Modify
		2: 500kbps 3: 250kbps 4: 125kbps 5: 100kbps 6: 50kbps 7: 20kbps		
P15.28	Master/slave CAN communication address	0–127	1	☉
P15.29	Master/slave CAN communication baud rate selection	0: 50Kbps 1: 100 Kbps 2: 125Kbps 3: 250Kbps 4: 500Kbps 5: 1M bps	2	☉
P15.30	Master/slave CAN communication timeout period	0.0 (invalid)–60.0s	5.0s	○
P15.31–P15.42	Reserved			
P15.43	Communication control word expression format	0–1 0: Decimal format 1: Binary format	0	☉
P15.44	Communication card control word/status word display selection	0–6 1: Currently identified card (only one) 2: DP card 3: PROFINET card 4: Ethernet IP card 5: Modbus TCP card 6: EtherCAT card	0	○

**P16 group—Functions of communication expansion card 2**

Function code	Name	Detailed parameter description	Default value	Modify
P16.00–P16.01	Reserved			



Function code	Name	Detailed parameter description	Default value	Modify
P16.02	Ethernet monitoring card IP address 1	0-255	192	⊙
P16.03	Ethernet monitoring card IP address 2	0-255	168	⊙
P16.04	Ethernet monitoring card IP address 3	0-255	0	⊙
P16.05	Ethernet monitoring card IP address 4	0-255	1	⊙
P16.06	Ethernet monitoring card subnet mask 1	0-255	255	⊙
P16.07	Ethernet monitoring card subnet mask 2	0-255	255	⊙
P16.08	Ethernet monitoring card subnet mask 3	0-255	255	⊙
P16.09	Ethernet monitoring card subnet mask 4	0-255	0	⊙
P16.10	Ethernet monitoring card gateway 1	0-255	192	⊙
P16.11	Ethernet monitoring card gateway 2	0-255	168	⊙
P16.12	Ethernet monitoring card gateway 3	0-255	0	⊙
P16.13	Ethernet monitoring card gateway 4	0-255	1	⊙
P16.14	Ethernet monitoring	0x0000-0xFFFF	0x0000	○

Function code	Name	Detailed parameter description	Default value	Modify
	variable address 1			
P16.15	Ethernet monitoring variable address 2	0x0000–0xFFFF	0x0000	<input type="radio"/>
P16.16	Ethernet monitoring variable address 3	0x0000–0xFFFF	0x0000	<input type="radio"/>
P16.17	Ethernet monitoring variable address 4	0x0000–0xFFFF	0x0000	<input type="radio"/>
P16.18–P16.23	Reserved			
P16.24	Identification time for the expansion card in card slot 1	0.0–600.0s If it is set to 0.0, identification fault will not be detected.	0.0s	<input type="radio"/>
P16.25	Identification time for the expansion card in card slot 2	0.0–600.0s If it is set to 0.0, offline fault will not be detected.	0.0s	<input type="radio"/>
P16.26	Identification time for the expansion card in card slot 3	0.0–600.0s If it is set to 0.0, offline fault will not be detected.	0.0s	<input type="radio"/>
P16.27	Communication timeout period of expansion card in card slot 1	0.0–600.0s If it is set to 0.0, offline fault will not be detected.	0.0s	<input type="radio"/>
P16.28	Communication timeout period of expansion card in card slot 2	0.0–600.0s If it is set to 0.0, offline fault will not be detected.	0.0s	<input type="radio"/>
P16.29	Communication timeout period of	0.0–600.0s If it is set to 0.0, offline fault will not be detected.	0.0s	<input type="radio"/>

Function code	Name	Detailed parameter description	Default value	Modify
	expansion card in card slot 3			
P16.30	Reserved			
P16.31	PROFINET communication timeout time	0.0–60.0s	5.0s	○
P16.32	Received PZD2	0–31	0	○
P16.33	Received PZD3	0: Invalid	0	○
P16.34	Received PZD4	1: Set frequency (0–Fmax. Unit: 0.01Hz)	0	○
P16.35	Received PZD5	2: PID reference (-1000–1000, in which 1000 corresponds to 100.0%)	0	○
P16.36	Received PZD6	3: PID feedback (-1000–1000, in which 1000 corresponds to 100.0%)	0	○
P16.37	Received PZD7	4: Torque setting (-3000–+3000, in which 1000 corresponds to 100.0% of the motor rated current)	0	○
P16.38	Received PZD8	5: Setting of the upper limit of forward running frequency (0–Fmax. Unit: 0.01 Hz)	0	○
P16.39	Received PZD9	6: Setting of the upper limit of reverse running frequency (0–Fmax. Unit: 0.01 Hz)	0	○
P16.40	Received PZD10	7: Upper limit of electromotive torque (0–3000, in which 1000 corresponds to 100.0% of the motor rated current)		
P16.41	Received PZD11	8: Upper limit of braking torque (0–3000, in which 1000 corresponds to 100% of the motor rated current)		
P16.42	Received PZD12	9: Virtual input terminal command (Range: 0x000–0x3FF, corresponding to S8/S7/S6/S5/HDIB/HDIA/S4/S3/S2/S1) 10: Virtual output terminal command (Range: 0x00–0x0F, corresponding to RO2/RO1/HDO/Y1) 11: Voltage setting (special for V/F separation) (0–1000, in which 1000 corresponds to 100% of the motor rated voltage) 12: AO1 output setting 1 (-1000–+1000, in which 1000 corresponds to 100.0%) 13: AO2 output setting 2 (-1000–1000, in which 1000 corresponds to 100.0%) 14: MSB of position reference (signed) 15: LSB of position reference (unsigned)	0	○

Function code	Name	Detailed parameter description	Default value	Modify
		16: MSB of position feedback (signed) 17: LSB of position feedback (unsigned) 18: Position feedback setting flag (position feedback can be set only after this flag is set to 1 and then to 0) 19: Function parameter mapping (PZD2–PZD12 correspond to P14.49–P14.59) 20–31: Reserved		
P16.43	Sent PZD2	0–47	0	<input type="radio"/>
P16.44	Sent PZD3	0: Invalid	0	<input type="radio"/>
P16.45	Sent PZD4	1: Running frequency (x100, Hz)	0	<input type="radio"/>
P16.46	Sent PZD5	2: Set frequency (x100, Hz)	0	<input type="radio"/>
P16.47	Sent PZD6	3: Bus voltage (x10, V)	0	<input type="radio"/>
P16.48	Sent PZD7	4: Output voltage (x1, V)	0	<input type="radio"/>
P16.49	Sent PZD8	5: Output current (x10, A)	0	<input type="radio"/>
P16.50	Sent PZD9	6: Actual output torque (x10, %)	0	<input type="radio"/>
P16.51	Sent PZD10	7: Actual output power (x10, %)	0	<input type="radio"/>
P16.52	Sent PZD11	8: Rotation speed of running (x1, rpm)	0	<input type="radio"/>
P16.53	Sent PZD12	9: Linear speed of running (x1, m/s) 10: Ramp reference frequency 11: Fault code 12: AI1 input (x100, V) 13: AI2 input (x100, V) 14: AI3 input (x100, V) 15: HDIA frequency value (x1000, kHz) 16: Terminal input status 17: Terminal output status 18: PID reference (x10, %) 19: PID feedback (x10, %) 20: Motor rated torque 21: MSB of position reference (signed) 22: LSB of position reference (unsigned) 23: MSB of position feedback (signed) 24: LSB of position feedback (unsigned) 25: Status word 26: HDIB frequency value (x1000, kHz) 27: MSB of PG card pulse feedback 28: LSB of PG card pulse feedback 29: MSB of PG card pulse reference	0	<input type="radio"/>

Function code	Name	Detailed parameter description	Default value	Modify
		30: LSB of PG card pulse reference 31: Function parameter mapping (PZD2–PZD12 correspond to P14.60–P14.70) 32: Status word 3 33–47: Reserved		
P16.54	Ethernet IP communication timeout time	0.0–60.0s	5.0	○
P16.55	Ethernet IP communication rate	0–4 0: Self-adaptive 1: 100M full-duplex 2: 100M half-duplex 3: 10M full-duplex 4: 10M half-duplex	0	◎
P16.56	Bluetooth pairing code	0–65535	0	●
P16.57	Bluetooth host type	0–65535 0: No host connection 1: Mobile APP 2: Bluetooth box 3–65535: Reserved	0	●
P16.58	Industrial Ethernet communication card IP address 1	0–255	192	◎
P16.59	Industrial Ethernet communication card IP address 2	0–255	168	◎
P16.60	Industrial Ethernet communication card IP address 3	0–255	0	◎
P16.61	Industrial Ethernet communication card IP address 4	0–255	20	◎
P16.62	Industrial Ethernet communication card subnet mask 1	0–255	255	◎
P16.63	Industrial Ethernet communication card subnet mask 2	0–255	255	◎

Function code	Name	Detailed parameter description	Default value	Modify
P16.64	Industrial Ethernet communication card subnet mask 3	0–255	255	☉
P16.65	Industrial Ethernet communication card subnet mask 4	0–255	0	☉
P16.66	Industrial Ethernet communication card gateway 1	0–255	192	☉
P16.67	Industrial Ethernet communication card gateway 2	0–255	168	☉
P16.68	Industrial Ethernet communication card gateway 3	0–255	0	☉
P16.69	Industrial Ethernet communication card gateway 4	0–255	1	☉
P16.70	Saving EtherCAT written function codes	0–1 0: Not save 1: Save	0	○
P16.71	Reserved			
P16.72	EtherCAT input unit selection	0–1 0: The input rotation speed unit is PRM 1: The input rotation speed unit is plus/s	0	○
P16.73	EtherCAT slave address	0x0000–0xFFFF	0xFFFF	○
P16.74	EtherCAT-DC synchronization cycle selection	0–5 0: Reserved 1: Reserved 2: 1ms 3: 2ms 4: 4ms 5: 8ms	0	○
P16.75	EtherCAT communication timeout time	0.0–60.0s	5.0s	○

Function code	Name	Detailed parameter description	Default value	Modify
P16.76	EtherCAT supported PLC type	0-8: Reserved	0	<input type="radio"/>
P16.77	EtherCAT run mode	0-2 0: Free-run mode 1: SM mode (synchronized in data input and output) 2: DC mode (synchronized in distributed clocks)	0	<input type="radio"/>

**P17 group—Status viewing**

Function code	Name	Detailed parameter description	Default value	Modify
P17.00	Set frequency	Display current set frequency of the VFD. Range: 0.00Hz–P00.03	0.00Hz	●
P17.01	Output frequency	Display current output frequency of the VFD. Range: 0.00Hz–P00.03	0.00Hz	●
P17.02	Ramp reference frequency	Display current ramp reference frequency of the VFD. Range: 0.00Hz–P00.03	0.00Hz	●
P17.03	Output voltage	Display current output voltage of the VFD. Range: 0–1200V	0V	●
P17.04	Output current	Display the valid value of current output current of the VFD. Range: 0.0–5000.0A	0.0A	●
P17.05	Motor speed	Display current motor speed. Range: 0–65535 rpm	0 rpm	●
P17.06	Torque current	Display current torque current of the VFD. Range: -3000.0–3000.0A	0.0A	●
P17.07	Exciting current	Display current exciting current of the VFD. Range: -3000.0–3000.0A	0.0A	●
P17.08	Motor power	Display current motor power; 100% relative to rated motor power, positive value is motoring state, negative value is generating state. Range: -300.0–300.0% (relative to rated motor power)	0.0%	●
P17.09	Motor output torque	Display current output torque of the VFD; 100% relative to rated motor torque, during forward running, positive value is motoring state, negative value is generating state, during reverse running,	0.0%	●

Function code	Name	Detailed parameter description	Default value	Modify
		positive value is generating state, negative value is motoring state. Range: -250.0–250.0%		
P17.10	Estimated motor frequency	The estimated motor rotor frequency under open-loop vector condition. Range: 0.00–P00.03	0.00Hz	●
P17.11	DC bus voltage	Display current DC bus voltage of the VFD. Range: 0.0–2000.0V	0V	●
P17.12	Digital input terminal state	Display current digital input terminal state of the VFD. 0x00–0x3F Bit0: S1 Bit1: S2 Bit2: S3 Bit3: S4 Bit4: HDIA Bit5: HDIB	0x00	●
P17.13	Digital output terminal state	Display current digital output terminal state of the VFD. 0x00–0x0F Bit0: Y1 Bit1: HDO Bit2: RO1 Bit3: RO2	0x00	●
P17.14	Digital adjustment variable	Display the regulating variable by <u>UP/DOWN</u> terminals of the VFD. Range: 0.00Hz–P00.03	0.00Hz	●
P17.15	Torque reference value	Relative to percentage of the rated torque of current motor, display torque reference. Range: -300.0%–300.0% (of the motor rated current)	0.0%	●
P17.16	Linear speed	0–65535	0	●
P17.17	Reserved			
P17.18	Count value	0–65535	0	●
P17.19	AI1 input voltage	Display input signal of AI1 Range: 0.00–10.00V	0.00V	●
P17.20	AI2 input voltage	Display input signal of AI2 Range: -10.00V–10.00V	0.00V	●



Function code	Name	Detailed parameter description	Default value	Modify
P17.21	HDIA input frequency	Display input frequency of HDIA Range: 0.000–50.000kHz	0.000 kHz	●
P17.22	HDIB input frequency	Display input frequency of HDIB Range: 0.000–50.000kHz	0.000 kHz	●
P17.23	PID reference value	Display PID reference value Range: -100.0–100.0%	0.0%	●
P17.24	PID feedback value	Display PID feedback value Range: -100.0–100.0%	0.0%	●
P17.25	Motor power factor	Display the power factor of current motor. Range: -1.00–1.00	0.00	●
P17.26	Current running time	Display current running time of the VFD. Range: 0–65535min	0min	●
P17.27	Simple PLC and current stage number of multi-step speed	Display the present stage of the simple PLC function. Range: 0–15	0	●
P17.28	Motor ASR controller output	Display the speed loop ASR controller output value under vector control mode, relative to the percentage of rated torque of the motor. Range: -300.0%–300.0% (of the motor rated current)	0.0%	●
P17.29	Pole angle of open-loop synchronous motor	Display initial identification angle of synchronous motor Range: 0.0–360.0	0.0	●
P17.30	Phase compensation of synchronous motor	Display phase compensation of synchronous motor Range: -180.0–180.0	0.0	●
P17.31	High-frequency superposition current of synchronous motor	0.0%–200.0% (of the rated motor current)	0.0	●
P17.32	Motor flux linkage	0.0%–200.0%	0.0%	●
P17.33	Exciting current reference	Display the exciting current reference value under vector control mode Range: -3000.0–3000.0A	0.0A	●

Function code	Name	Detailed parameter description	Default value	Modify
P17.34	Torque current reference	Display torque current reference value under vector control mode Range: -3000.0–3000.0A	0.0A	●
P17.35	AC incoming current	Display the valid value of incoming current on AC side Range: 0.0–5000.0A	0.0A	●
P17.36	Output torque	Display output torque value, during forward running, positive value is motoring state, negative value is generating state; during reverse running, positive value is generating state, negative value is motoring state. Range: -3000.0Nm–3000.0Nm	0.0Nm	●
P17.37	Motor overload count value	0–65535	0	●
P17.38	Process PID output	-100.0%–100.0%	0.00%	●
P17.39	Parameter download wrong function code	0.00–99.00	0.00	●
P17.40	Motor control mode	Ones: Control mode 0: Vector 0 1: Vector 1 2: VF control 3: Closed-loop control Tens: Control state 0: Speed control 1: Torque control 2: Position control Hundreds: Motor number 0: Motor 1 1: Motor 2	0x2	●
P17.41	Upper limit of the torque when motoring	0.0%–300.0% (of the motor rated current)	0.0%	●
P17.42	Upper limit of braking torque	0.0%–300.0% (of the motor rated current)	0.0%	●
P17.43	Upper limit frequency of forward running	0.00Hz–P00.03	0.00Hz	●

Function code	Name	Detailed parameter description	Default value	Modify
	of torque control			
P17.44	Upper limit frequency of reverse running of torque control	0.00Hz~P00.03	0.00Hz	●
P17.45	Inertia compensation torque	-100.0%~100.0%	0.0%	●
P17.46	Friction compensation torque	-100.0%~100.0%	0.0%	●
P17.47	Motor pole pairs	0~65535	0	●
P17.48	VFD overload count value	0~65535	0	●
P17.49	Frequency set by A source	0.00~P00.03	0.00Hz	●
P17.50	Frequency set by B source	0.00~P00.03	0.00Hz	●
P17.51	PID proportional output	-100.0%~100.0%	0.0%	●
P17.52	PID integral output	-100.0%~100.0%	0.0%	●
P17.53	PID differential output	-100.0%~100.0%	0.0%	●
P17.54	Actual PID proportional gain	0.00~100.00	0.00	●
P17.55	Actual PID integral time	0.00~10.00s	0.00s	●
P17.56	Actual PID differential time	0.00~10.00s	0.00s	●
P17.57	Current step of multi-step speed running	0~15	0	●
P17.58	Peak-to-peak value at 100Hz frequency component (square-wave)	0.0~300.0V Peak-to-peak value of bus voltage fluctuation at 100Hz frequency component, which is detected by using a square-wave orthogonal function	0.0V	●

Function code	Name	Detailed parameter description	Default value	Modify
	orthogonal function detected)			
P17.59	Peak-to-peak value at 100Hz frequency component (sine-wave orthogonal function detected)	0.0–300.0V Peak-to-peak value of bus voltage fluctuation at 100Hz frequency component, which is detected by using a sine-wave orthogonal function	0.0V	●
P17.60	Reserved			
P17.61	Status machine value	0–10 0: Reserved 1: Initializing 2: Pre-operating 3: Reserved 4: Safe running 5–7: Reserved 8: Operating 9–10: Reserved	0	●
P17.62	EtherCAT control word	0–65535	0	●
P17.63	EtherCAT status word	0–65535	0	/●
P17.64	VFD status word 3	0x0000–0xFFFF Bit0: Running with protection Bit1: Running Bit2: Running direction (1=REV, 0=FWD) Bit3: jogging Bit4: Pre-alarming Bit5: - In fault Bit6: Suspended Bit7: In sleep Bit8: PoFF Bit9: Undervoltage due to transient power loss Bit10: Underspeed due to overvoltage Bit11: Pre-exciting Bit12: DC braking Bit13: Identifying parameters	0x0000	

Function code	Name	Detailed parameter description	Default value	Modify
		Bit14: Flux weakening (reserved) Bit15: Reserved		

**P18 group—Closed-loop control state check**

Function code	Name	Detailed parameter description	Default value	Modify
P18.00	Actual frequency of encoder	The actual-measured encoder frequency; the value of forward running is positive; the value of reverse running is negative. Range: -999.9–3276.7Hz <b>Note: P18.00 is displayed only in the V/F and closed-loop modes, but not in the open-loop mode.</b>	0.0Hz	●
P18.01	Encoder position count value	Encoder count value, quadruple frequency. Range: 0–65535	0	●
P18.02	Encoder Z pulse count value	Corresponding count value of encoder Z pulse. Range: 0–65535	0	●
P18.03	High bit of position reference value	High bit of position reference value, zero out after stop. Range: 0–30000	0	●
P18.04	Low bit of position reference value	Low bit of position reference value, zero out after stop. Range: 0–65535	0	●
P18.05	High bit of position feedback value	High bit of position feedback value, zero out after stop. Range: 0–30000	0	●
P18.06	Low bit of position feedback value	Low bit of position feedback value, zero out after stop. Range: 0–65535	0	●
P18.07	Position deviation	Deviation between current reference position and actual running position. Range: -32768–32767	0	●
P18.08	Position of position reference point	Position of reference point of Z pulse when the spindle stops accurately. Range: 0–65535	0	●
P18.09	Current position setting of spindle	Current position setting when the spindle stops accurately. Range: 0–359.99°	0.00°	●
P18.10	Current position	Current position when spindle stops accurately.	0	●

Function code	Name	Detailed parameter description	Default value	Modify
	when spindle stops accurately	Range: 0–65535		
P18.11	Encoder Z pulse direction	Z pulse direction display. When the spindle stops accurately, there may be a couple of pulses' error between the position of forward and reverse orientation, which can be eliminated by adjusting Z pulse direction of P20.02 or exchanging phase AB of encoder. 0: Forward 1: Reverse	0	●
P18.12	Encoder Z pulse angle	Reserved. Range: 0.00–359.99°	0.00°	●
P18.13	Encoder Z pulse error times	Reserved. Range: 0–65535	0	●
P18.14	High bit of encoder pulse count value	0–65535	0	●
P18.15	Low bit of encoder pulse count value	0–65535	0	●
P18.16	Main control board measured speed value	-3276.8–3276.7Hz	0.0Hz	●
P18.17	Pulse command frequency	Pulse command (A2, B2 terminal) is converted to the set frequency, and it is valid under pulse position mode and pulse speed mode. Range: -3276.8–3276.7Hz	0.00Hz	●
P18.18	Pulse command feedforward	Pulse command (A2, B2 terminal) is converted to the set frequency, and it is valid under pulse position mode and pulse speed mode. Range: -3276.8–3276.7Hz	0.00Hz	●
P18.19	Position regulator output	The output frequency of the position regulator during position control. Range: -327.68–327.67Hz	0.00Hz	●
P18.20	Count value of resolver	Count value of resolver. Range: 0–65535	0	●
P18.21	Resolver angle	The pole position angle read according to the resolver-type encoder.	0.00°	●

Function code	Name	Detailed parameter description	Default value	Modify
		Range: 0.00–359.99°		
P18.22	Pole angle of closed-loop synchronous motor	Current pole position. Range: 0.00–359.99°	0.00°	●
P18.23	Status word 2	0x0000–0xFFFF	0x0000	●
P18.24	High bit of count value of PG card pulse reference	0–65535	0	●
P18.25	Low bit of count value of PG card pulse reference	0–65535	0	●
P18.26	PG card measured speed value	-3276.8–3276.7Hz	0.0Hz	●
P18.27	Encoder UVW sector	0–7	0	●
P18.28	Encoder PPR (pulse-per-revolution) display	0–65535	0	●
P18.29	Angle compensation value of synchronous motor	-180.0–180.0	0.00	●
P18.30	Z pulse angle of synchronous motor	0.00–655.35	0.00	●
P18.31	Pulse reference Z pulse value	0–65535	0	●
P18.32	Pulse-given main control board measured speed value	-3276.8–3276.7Hz	0.0Hz	●
P18.33	Pulse-given PG card measured speed value	-3276.8–3276.7Hz	0.0Hz	●

Function code	Name	Detailed parameter description	Default value	Modify
P18.34	Present encoder filter width	0–63	0	●
P18.35	8k test duration	0–65535	0	●

**P19 group—Expansion card state check**

Function code	Name	Detailed parameter description	Default value	Modify
P19.00	Type of card at slot 1	0–65535 0: No card	0	●
P19.01	Type of card at slot 2	1: Programmable card 2: I/O card	0	●
P19.02	Type of card at slot 3	3: Incremental PG card 4: Incremental PG card with UVW 5: Ethernet communication card 6: DP communication card 7: Bluetooth card 1 8: Resolver PG card 9: CANopen communication card 10: WIFI card 11: PROFINET communication card 12: Sine/Cosine PG card without CD signal 13: Sine/Cosine PG card with CD signal 14: Absolute encoder PG card 15: CAN master/slave communication card 16: Modbus/Modbus TCP communication card 17: EtherCAT communication card 20: PT100/PT1000 temperature detection card 21: EtherNet IP communication card 23: Bluetooth card 2 24–65535: Reserved	0	●
P19.03	Software version of the expansion card in card slot 1	0.00–655.35	0.00	●
P19.04	Software version of the expansion card in card slot 2	0.00–655.35	0.00	●



Function code	Name	Detailed parameter description	Default value	Modify
P19.05	Software version of the expansion card in card slot 3	0.00–655.35	0.00	●
P19.06	Input state of expansion I/O card terminals	0–0xFFFF	0	●
P19.07	Output state of expansion I/O card terminals	0–0xFFFF	0	●
P19.08	Reserved			
P19.09	AI3 input voltage of expansion I/O card	0.00–10.00V	0.00V	●
P19.10	EC PT100 detected temperature	-50.0–150.0°C	0.0°C	●
P19.11	EC PT100 detected digital	0–4096	0	●
P19.12	EC PT1000 detected temperature	-50.0–150.0°C	0.0°C	●
P19.13	EC PT1000 detected digital	0–4096	0	●
P19.14	Alarm display	0–4 0: No alarm 1: PT100 detected OH alarm 2: PT1000 detected OH alarm 3: PT100 disconnection alarm 4: PT1000 disconnection alarm	0	●
P19.15	VFD control word	0–65535	0	●
P19.16	VFD status word	0–65535	0	●
P19.17	Ethernet monitoring variable 1	0–65535	0	●
P19.18	Ethernet monitoring variable 2	0–65535	0	●
P19.19	Ethernet	0–65535	0	●

Function code	Name	Detailed parameter description	Default value	Modify
	monitoring variable 3			
P19.20	Ethernet monitoring variable 4	0–65535	0	●
P19.21	AI/AO detected temperature	-20.0–200.0°C	0.0°C	●
P19.22	Variable address of speed reference calibration value	0x0000–0xFFFF	0x0000	●
P19.23	Variable address of speed feedback calibration value	0x0000–0xFFFF	0x0000	●

**P20 group—Encoder of motor 1**

Function code	Name	Detailed parameter description	Default value	Modify
P20.00	Encoder type display	0: Incremental encoder 1: Resolver-type encoder 2: Sin/Cos encoder 3: Endat absolute encoder 4: SSI absolute encoder 5–6: Reserved	0	●
P20.01	Encoder pulse number	Number of pulses generated when the encoder revolves for one circle. Setting range: 0–16000	1024	◎
P20.02	Encoder direction	Ones: AB direction 0: Forward 1: Reverse Tens: Z pulse direction (reserved) 0: Forward 1: Reverse Hundreds: CD/UVW pole signal direction 0: Forward 1: Reverse	0x000	◎
P20.03	Detection time of encoder offline	The detection time of encoder offline fault. Setting range: 0.0–10.0s	2.0s	○

Function code	Name	Detailed parameter description	Default value	Modify
	fault	Note: When the value is 0.0s, the fault will not be detected.		
P20.04	Detection time of encoder reversal fault	Detection time of encoder reversal fault. Setting range: 0.0–100.0s	0.8s	<input type="radio"/>
P20.05	Filter times of encoder detection	Setting range: 0x00–0x99 Ones: Low-speed filter time, corresponds to $2^{(0-9)} \times 125\mu\text{s}$ . Tens: High-speed filter times, corresponds to $2^{(0-9)} \times 125\mu\text{s}$ .	0x33	<input type="radio"/>
P20.06	Speed ratio between encoder mounting shaft and motor	You need to set this parameter when the encoder is not installed on the motor shaft and the drive ratio is not 1. Setting range: 0.00–655.35	1.00	<input type="radio"/>
P20.07	Control parameters of synchronous motor	Bit0: Enable Z pulse calibration Bit1: Enable encoder angle calibration Bit2: Enable SVC speed measurement Bit3: Reserved Bit4: Reserved Bit5: Reserved Bit6: Enable CD signal calibration Bit7: Reserved Bit8: Do not detect encoder fault during autotuning Bit9: Enable Z pulse detection optimization Bit10: Enable initial Z pulse calibration optimization Bit11: Update the initial angle Bit12: Clear Z pulse arrival signal after stop Bit13: Reserved Bit14: Detect Z pulse after one rotation Bit15: Reserved	0x0003	<input type="radio"/>
P20.08	Enable Z pulse offline detection	0x00–0x11 Ones: Z pulse 0: Do not detect 1: Enable Tens: UVW pulse (for synchronous motor) 0: Do not detect 1: Enable	0x10	<input type="radio"/>

Function code	Name	Detailed parameter description	Default value	Modify
P20.09	Initial angle of Z pulse	Relative electric angle of encoder Z pulse and motor pole position. Setting range: 0.00–359.99°	0.00°	<input type="radio"/>
P20.10	Initial angle of the pole	Relative electric angle of encoder position and motor pole position. Setting range: 0.00–359.99°	0.00°	<input type="radio"/>
P20.11	Autotuning of initial angle of pole	0–3 0: No operation 1: Rotary autotuning (DC braking) 2: Static autotuning (suitable for resolver-type encoder, sin/cos with CD signal feedback) 3: Rotary autotuning (initial angle identification)	0	<input checked="" type="radio"/>
P20.12	Speed measurement optimization selection	0–2 0: No optimization 1: Optimization mode 1 2: Optimization mode 2	1	<input checked="" type="radio"/>
P20.13	CD signal zero offset gain	0–65535	0	<input type="radio"/>
P20.14	Encoder type selection	Ones: Incremental encoder 0: without UVW 1: with UVW Tens: Sin/Cos encoder 0: without CD signal 1: with CD signal	0x00	<input checked="" type="radio"/>
P20.15	Speed measurement mode	0: PG card 1: Local; realized by HDIA and HDIB; supports incremental 24V encoder only	0	<input checked="" type="radio"/>
P20.16	Frequency-division coefficient	0–255 When this parameter is set to 0 or 1, frequency division of 1:1 is implemented.	0	<input type="radio"/>
P20.17	Pulse filter processing	0x0000–0xFFFF Bit0: Enable/disable encoder input filter 0: No filter 1: Filter Bit1: Encoder signal filter mode (set Bit0 or Bit2 to 1) 0: Self-adaptive filter 1: Use P20.18 filter parameters Bit2: Enable/disable encoder frequency-division	0x0033	<input type="radio"/>

Function code	Name	Detailed parameter description	Default value	Modify
		output filter 0: No filter 1: Filter Bit3: Enable/disable filter for frequency-division output of pulse reference 0: No filter 1: Filter Bit4: Enable/disable pulse reference filter 0: No filter 1: Filter Bit5: Pulse reference filter mode (valid when Bit4 is set to 1) 0: Self-adaptive filter 1: Use P20.19 filter parameters Bit6: Frequency-divided output source setting (valid only for incremental encoders) 0: Encoder signals 1: Pulse reference signals Bits7–15: Reserved		
P20.18	Encoder pulse filter width	0–63 The filtering time is $P20.18 \times 0.25 \mu s$ . The value 0 or 1 indicates $0.25 \mu s$ .	2	<input type="radio"/>
P20.19	Pulse reference filter width	0–63 The filtering time is $P20.19 \times 0.25 \mu s$ . The value 0 or 1 indicates $0.25 \mu s$ .	2	<input type="radio"/>
P20.20	Pulse number of pulse reference	0–16000	1024	<input checked="" type="radio"/>
P20.21	Enable angle compensation of synchronous motor	0–1	1	<input type="radio"/>
P20.22	Switchover frequency threshold of speed measurement mode	0.00Hz–P00.03 <b>Note:</b> This parameter is valid only when P20.12 is set to 0.	1.00Hz	<input type="radio"/>
P20.23	Synchronous motor angle	-200.0–200.0%	100.0%	<input type="radio"/>

Function code	Name	Detailed parameter description	Default value	Modify
	compensation coefficient			
P20.24	Number of pole pairs in initial magnetic pole angle autotuning	1–128	2	☉
P20.25	SSI encoder type	0–1 0: Single-turn 1: Multi-turn	1	☉
P20.26	SSI encoder single-turn resolution	0–20	14	○
P20.27	SSI encoder single-turn resolution (total)	0–20	12	○

**P21 group—Position control**

Function code	Name	Detailed parameter description	Default value	Modify
P21.00	Positioning mode	0x0000–0x7121 Ones: Control mode selection 0: Speed control 1: Position control Tens: Position command source 0: Pulse train 1: Digital position 2: Positioning of photoelectric switch during stop Hundreds: Position feedback source (reserved, fixed to channel P) 0: PG1 1: PG2 Thousands: Servo mode 0: Servo disabled, without position deviation 1: Servo disabled, with position deviation 2: Servo enabled, without position deviation 3: Servo enabled, with position deviation 4–7: Reserved	0x0000	○
P21.01	Pulse command mode	0x0000–0x3133 Ones: Pulse mode	0x0000	☉

Function code	Name	Detailed parameter description	Default value	Modify
		0: A/B quadrature pulse; A precedes B 1: A: PULSE; B: SIGN If channel B is of low electric level, the edge counts up; if channel B is of high electric level, the edge counts down. 2: A: Positive pulse Channel A is positive pulse; channel B needs no wiring. 3: A/B dual-channel pulse; channel A pulse edge counts up, channel B pulse edge counts down Tens: Pulse direction selection 0: Forward 1: Reverse 2: Specified by the running direction 3: Reserved Hundreds: Frequency-multiplication selection for pulse + direction (reserved) 0: No frequency-multiplication 1: Frequency-multiplication Thousands: Pulse control selection 0: Pulse inertia filter, without overspeed control 1: Average moving filter, without overspeed control 2: Pulse inertia filter, with overspeed control 3: Average moving filter, with overspeed control		
P21.02	APR gain 1	The two automatic position regulator (APR) gains are switched based on the switching mode set in P21.04. When the spindle orientation function is used, the gains are switched automatically, regardless of the setting of P21.04. P21.03 is used for dynamic running, and P21.02 is used for maintaining the locked state. Setting range: 0.0–400.0	20.0	○
P21.03	APR gain 2		30.0	○
P21.04	Switching mode of position loop gain	Used to set the APR gain switching mode. To use torque command-based switching, you need to set P21.05; and to use speed command-based switching, you need to set P21.06. 0: No switching 1: Torque command 2: Speed command	0	○

Function code	Name	Detailed parameter description	Default value	Modify
		3–5: Reserved		
P21.05	Torque command level during position gain switchover	0.0–100.0% (rated motor torque)	10.0%	<input type="radio"/>
P21.06	Speed command level during position gain switchover	0.0–100.0% (rated motor speed)	10.0%	<input type="radio"/>
P21.07	Smooth filter coefficient during gain switchover	The smooth filter coefficient during position gain switchover. Setting range: 0–15	5	<input type="radio"/>
P21.08	Output limit of position controller	The output limit of position regulator, if the limit value is 0, position regulator will be invalid, and no position control can be performed, however, speed control is available. Setting range: 0.0–100.0% (Max. output frequency P00.03)	20.0%	<input type="radio"/>
P21.09	Completion range of positioning	When the position deviation is less than P21.09, and the duration is larger than P21.10, positioning completion signal will be outputted. Setting range: 0–1000	10	<input type="radio"/>
P21.10	Detection time for positioning completion	0.0–1000.0ms	10.0ms	<input type="radio"/>
P21.11	Numerator of position command ratio	Electronic gear ratio, used to adjust the corresponding relation between position command and actual running displacement. Setting range: 1–65535	1000	<input type="radio"/>
P21.12	Denominator of position command ratio	Setting range: 1–65535	1000	<input type="radio"/>
P21.13	Position feedforward gain	0.00–120.00% For Pulse train reference only (position control)	100.00	<input type="radio"/>
P21.14	Position feedforward filter time constant	0.0–3200.0ms For Pulse train reference only (position control)	3.0ms	<input type="radio"/>
P21.15	Position	The position feedforward filter time constant during	0.0ms	<input checked="" type="radio"/>



Function code	Name	Detailed parameter description	Default value	Modify
	command filter time constant	Pulse train positioning. 0.0–3200.0ms		
P21.16	Digital positioning mode	0x0000–0xFFFF Bit0: Positioning mode selection 0: Relative position 1: Absolute position (home) (reserved) Bit1: Positioning cycle selection 0: Cyclic positioning by terminals 1: Automatic cyclic positioning Bit2: Cycle mode 0: Continuous 1: Repetitive (supported by automatic cyclic positioning only) Bit3: P21.17 digital setting mode 0: Incremental 1: Position type (do not support continuous mode) Bit4: Home searching mode 0: Search for the home just once 1: Search for the home during each run Bit5: Home calibration mode 0: Calibrate in real time 1: Single calibration Bit6: Positioning completion signal selection 0: Valid during the time set by P21.25 (Hold time of positioning completion signal) 1: Always valid Bit7: Initial positioning selection (for cyclic positioning by terminals) 0: Invalid (do not rotate) 1: Valid Bit8: Positioning enable signal selection (for cyclic positioning by terminals only; positioning function is always enabled for automatic cyclic positioning) 0: Pulse signal 1: Level signal Bit9: Position source 0: P21.17 setting 1: CANopen/PROFINET/EtherNet IP/EtherCAT communication setting	0x0000	○

Function code	Name	Detailed parameter description	Default value	Modify
		Bit10: Whether to save the encoder pulse counting value at power failure 0: Do not save 1: Save Bit 11: Reserved Bit12: Positioning curve selection (reserved) 0: Straight line 1: S curve		
P21.17	Position digital reference	Set digital positioning position; Actual position=P21.17×P21.11/P21.12 0–65535	0	<input type="radio"/>
P21.18	Positioning speed setting selection	0: Set by P21.19 1: Set by AI1 2: Set by AI2 3: Set by AI3 4: Set by high-speed pulse HDIA 5: Set by high-speed pulse HDIB 6: Set by EtherCAT communication	0	<input type="radio"/>
P21.19	Positioning speed digits	0–100.0% of the max. frequency	20.0%	<input type="radio"/>
P21.20	Acceleration time of positioning	Set the acceleration/deceleration time of positioning process.	3.00s	<input type="radio"/>
P21.21	Deceleration time of positioning	Acceleration time of positioning means the time needed for the VFD to accelerate from 0Hz to Max. output frequency (P00.03). Deceleration time of positioning means the time needed for the VFD to decelerate from Max. output frequency (P00.03) to 0Hz. Setting range of P21.20: 0.01–300.00s Setting range of P21.21: 0.01–300.00s	3.00s	<input type="radio"/>
P21.22	Hold time of positioning arrival	Set the hold time of waiting when target positioning position is reached. Setting range: 0.000–60.000s	0.100s	<input type="radio"/>
P21.23	Home search speed	0.00–50.00Hz	2.00Hz	<input type="radio"/>
P21.24	Home position offset	0–65535	0	<input type="radio"/>
P21.25	Hold time of positioning	The hold time of positioning completion signal, this parameter is also valid for positioning completion	0.200s	<input type="radio"/>

Function code	Name	Detailed parameter description	Default value	Modify
	completion signal	signal of spindle orientation. Setting range: 0.000–60.000s		
P21.26	Pulse superposition value	P21.26: 0–65535 P21.27: 0.0–6553.5 pulses/ms This function is enabled in the pulse speed reference (P00.06=12) or pulse position mode (P21.00=1):	0	<input type="radio"/>
P21.27	Pulse superposition rate	1. Input terminal function #68 (enable pulse superposition) When the rising edge of the terminal is detected, the pulse setting is increased to the value of P21.26, and the pulse reference channel is compensated by the pulse superposition rate set in P21.27. 2. Input terminal function #67 (progressive increase of pulses) When this terminal is enabled, the pulse reference channel is compensated by the pulse superposition rate set in P21.27. <b>Note:</b> Terminal filtering set in P05.09 may slightly affect the actual superposition. Example: P21.27 = 1.0 pulses/ms P05.05 = 67 If the input signal of terminal S5 is 0.5s, the actual number of superposed pulses is 500.	8.0 pulses/ms	<input type="radio"/>
P21.28	Acceleration/ deceleration time after disabling pulse	3. Input terminal function #69 (progressive decrease of pulses) The sequence of this function is the same as those described above. The difference lies in that this terminal indicates that negative pulses are superposed. <b>Note:</b> All the pulses described here are superposed on the pulse reference channel (A2, B2). Pulse filtering, electronic gear, and other functions are valid for superposed pulses. 4. Output terminal function #28 (pulse superposing) When pulses are superposed, the output terminal	5.0s	<input type="radio"/>

Function code	Name	Detailed parameter description	Default value	Modify
		operates. After pulses are superposed, the terminal does not operate.		
P21.29	Speed feedforward filter time constant (Pulse train speed mode)	It is the filter time constant detected by Pulse train when the speed reference source is set to Pulse train (P0.06=12 or P0.07=12). Setting range: 0–3200.0ms	10.0ms	○
P21.30	Numerator of the 2nd command ratio	1–65535	1000	○
P21.31	Pulse reference speed measuring method	0–2 0: Main control board 1: PG card 2: Hybrid	0	○
P21.32	Pulse reference feedforward source	0x0–0x1	0x0	◎
P21.33	Set value of clearing encoder count	0–65535	0	◎

**P22 group—Spindle positioning**

Function code	Name	Detailed parameter description	Default value	Modify
P22.00	Spindle positioning mode selection	Bit0: Enable spindle positioning 0: Disable 1: Enable Bit1: Select spindle positioning reference point 0: Z pulse input 1: S2/S3/S4 terminal input Bit2: Search for reference point 0: Search the reference point only once 1: Search the reference point every time Bit3: Enable reference point calibration 0: Disable 1: Enable Bit4: Positioning mode selection 1 0: Set direction positioning 1: Near-by direction positioning	0x0000	○

Function code	Name	Detailed parameter description	Default value	Modify
		Bit5: Positioning mode selection 2 0: Forward positioning 1: Reverse positioning Bit6: Zeroing command selection 0: Electric level mode 1: Pulse mode Bit7: Reference point calibration mode 0: Calibrate at the first time 1: Calibrate in real time Bit8: Action selection after zeroing signal cancellation (electric level type) 0: Switch to speed mode 1: Position lock mode Bit9: Positioning completion signal selection 0: Electric level signal 1: Pulse signal Bit10: Z pulse signal source 0: Motor 1: Spindle Bit11–15: Reserved		
P22.01	Speed of spindle orientation	During spindle orientation, the speed of the position point of orientation will be searched, and then it will switch over to position control orientation. Setting range: 0.00–100.00Hz	10.00Hz	○
P22.02	Deceleration time of spindle orientation	Deceleration time of spindle orientation. Spindle orientation deceleration time means the time needed for the VFD to decelerate from Max. output frequency (P00.03) to 0Hz. Setting range: 0.0–100.0s	3.0s	○
P22.03	Spindle zeroing position 0	You can select the zeroing positions of four spindles by terminals (functions 46 and 47). Setting range: 0–65535	0	○
P22.04	Spindle zeroing position 1	Setting range: 0–65535	0	○
P22.05	Spindle zeroing position 2	Setting range: 0–65535	0	○
P22.06	Spindle zeroing position 3	Setting range: 0–65535	0	○

Function code	Name	Detailed parameter description	Default value	Modify
P22.07	Spindle scale-division angle 1	You can select seven spindle scale-division values by terminals (functions 48, 49 and 50). Setting range: 0.00–359.99°	15.00°	<input type="radio"/>
P22.08	Spindle scale-division angle 2	Setting range: 0.00–359.99°	30.00°	<input type="radio"/>
P22.09	Spindle scale-division angle 3	Setting range: 0.00–359.99°	45.00°	<input type="radio"/>
P22.10	Spindle scale-division angle 4	Setting range: 0.00–359.99°	60.00°	<input type="radio"/>
P22.11	Spindle scale-division angle 5	Setting range: 0.00–359.99°	90.00°	<input type="radio"/>
P22.12	Spindle scale-division angle 6	Setting range: 0.00–359.99°	120.00°	<input type="radio"/>
P22.13	Spindle scale-division angle 7	Setting range: 0.00–359.99°	180.00°	<input type="radio"/>
P22.14	Spindle drive ratio	This function code sets the reduction ratio of the spindle and the mounting shaft of the encoder. Setting range: 0.001–30.000	1.000	<input type="radio"/>
P22.15	Zero-point communication setting of spindle	P22.15 sets spindle zero-point offset, if the selected spindle zero point is P22.03, the final spindle zero point will be the sum of P22.03 and P22.15. Setting range: 0–39999	0	<input type="radio"/>
P22.16–P22.17	Reserved			
P22.18	Rigid tapping selection	Ones: Enable/disable 0: Disable 1: Enable Tens: Analog input port selection 0: Invalid 1: AI1 2: AI2 3: AI3	0x00	<input checked="" type="radio"/>
P22.19	Analog filter time of rigid tapping	0.0ms–1000.0ms	1.0ms	<input type="radio"/>
P22.20	Max. frequency of rigid tapping	0.00–599.00Hz	50.00Hz	<input type="radio"/>
P22.21	Corresponding	0.00–10.00Hz	0.00Hz	<input type="radio"/>

Function code	Name	Detailed parameter description	Default value	Modify
	frequency of analog zero drift of rigid tapping			
P22.22–P22.24	Reserved			

**P23 group—Vector control of motor 2**

Function code	Name	Detailed parameter description	Default value	Modify
P23.00	Speed loop proportional gain 1	<p>P23.00–P23.05 fit for vector control mode only. Below switchover frequency 1 (P23.02), the speed loop PI parameters are P23.00 and P23.01. Above switchover frequency 2 (P23.05), the speed loop PI parameters are P23.03 and P23.04; in between them, the PI parameters are obtained by linear variation between two groups of parameters, as shown in the figure below.</p>	20.0	<input type="radio"/>
P23.01	Speed loop integral time 1		0.200s	<input type="radio"/>
P23.02	Switch over low point frequency		5.00Hz	<input type="radio"/>
P23.03	Speed loop proportional gain 2		20.0	<input type="radio"/>
P23.04	Speed loop integral time 2		0.200s	<input type="radio"/>
P23.05	Switch over high point frequency	<p>The speed loop dynamic response characteristics of vector control can be adjusted by setting the proportional coefficient and integral time of speed regulator. Increase proportional gain or decrease integral time can accelerate dynamic response of speed loop, however, if the proportional gain is too large or integral time is too small, system oscillation and large overshoot may occur; if proportional gain is too small, stable oscillation or speed offset may occur.</p> <p>Speed loop PI parameter is closely related to the system inertia, you should make adjustment according to different load characteristics based on the default PI parameter to fulfill different needs.</p> <p>Setting range of P23.00: 0.0–200.0 Setting range of P23.01: 0.000–10.000s</p>	10.00Hz	<input type="radio"/>

Function code	Name	Detailed parameter description	Default value	Modify
		Setting range of P23.02: 0.00Hz–P23.05 Setting range of P23.03: 0.0–200.0 Setting range of P23.04: 0.000–10.000s Setting range of P23.05: P23.02–P00.03 (Max. output frequency)		
P23.06	Speed loop output filter	0–8 (corresponds to 0–2 <sup>8</sup> /10ms)	0	<input type="radio"/>
P23.07	Slip compensation coefficient of vector control (motoring)	Slip compensation coefficient is used to adjust the slip frequency of vector control to improve system speed control precision. You can effectively control the static error of speed by adjusting this parameter properly. Setting range: 50–200%	100%	<input type="radio"/>
P23.08	Slip compensation coefficient of vector control (generating)		100%	<input type="radio"/>
P23.09	Current loop proportional coefficient P	<b>Note:</b> 1. These two parameters are used to adjust PI parameters of current loop; it affects dynamic response speed and control precision of the system directly. The default value needs no adjustment under common conditions; 2. Applicable to SVC mode 0 (P00.00=0), SVC mode 1 (P00.00=1), and FVC (P00.00=3) Setting range: 0–65535	1000	<input type="radio"/>
P23.10	Current loop integral coefficient I		1000	<input type="radio"/>
P23.11	Speed loop differential gain	0.00–10.00s	0.00s	<input type="radio"/>
P23.12	Proportional coefficient of high-frequency current loop	In the FVC (P00.00=3), when the frequency is lower than the current-loop high-frequency switching threshold (P23.14), the current-loop PI parameters are P23.09 and P23.10; and when the frequency is higher than the current-loop high-frequency switching threshold, the current-loop PI parameters are P23.12 and P23.13. Setting range of P23.12: 0–65535	1000	<input type="radio"/>
P23.13	Integral coefficient of high-frequency current loop		1000	<input type="radio"/>
P23.14	High-frequency switchover threshold of		Setting range of P23.13: 0–65535 Setting range of P23.14: 0.0–100.0% (relative to max. frequency)	100.0%



Function code	Name	Detailed parameter description	Default value	Modify
	current loop			
P23.15– P23.19	Reserved			

**P24 group—Encoder of motor 2**

Function code	Name	Detailed parameter description	Default value	Modify
P24.00	Encoder type display	0: Incremental encoder 1: Resolver-type encoder 2: Sin/Cos encoder 3: Endat absolute encoder 4: SSI absolute encoder 5–6: Reserved	0	●
P24.01	Encoder pulse number	Number of pulses generated when the encoder revolves for one circle. Setting range: 0–16000	1024	◎
P24.02	Encoder direction	Ones: AB direction 0: Forward 1: Reverse Tens: Z pulse direction (reserved) 0: Forward 1: Reverse Hundreds: CD/UVW pole signal direction 0: Forward 1: Reverse	0x000	◎
P24.03	Detection time of encoder offline fault	The detection time of encoder offline fault. Setting range: 0.0–10.0s	2.0s	○
P24.04	Detection time of encoder reversal fault	Detection time of encoder reversal fault. Setting range: 0.0–100.0s	0.8s	○
P24.05	Filter times of encoder detection	Setting range: 0x00–0x99 Ones: Low-speed filter times, corresponds to $2^{(0-9)} \times 125\mu\text{s}$ . Tens: High-speed filter times; corresponds to $2^{(0-9)} \times 125\mu\text{s}$ .	0x33	○
P24.06	Speed ratio between encoder mounting shaft	You need to set this parameter when the encoder is not installed on the motor shaft and the drive ratio is not 1.	1.00	○

Function code	Name	Detailed parameter description	Default value	Modify
	and motor	Setting range: 0.00–655.35		
P24.07	Control parameters of synchronous motor	0x0000–0xFFFF Bit0: Enable Z pulse calibration Bit1: Enable encoder angle calibration Bit2: Enable SVC speed measurement Bit3: Reserved Bit4: Reserved Bit5: Reserved Bit6: Enable CD signal calibration Bit7: Reserved Bit8: Do not detect encoder fault during autotuning Bit9: Enable Z pulse detection optimization Bit10: Enable initial Z pulse calibration optimization Bit11: Update the initial angle Bit12: Clear Z pulse arrival signal after stop Bit13: Reserved Bit14: Detect Z pulse after one rotation Bit15: Reserved	0x0003	○
P24.08	Enable Z pulse offline detection	0x00–0x11 Ones: Z pulse Reserved Tens: UVW pulse 0: Do not detect 1: Enable	0x10	○
P24.09	Initial angle of Z pulse	Relative electric angle of encoder Z pulse and motor pole position. Setting range: 0.00–359.99°	0.00°	○
P24.10	Initial angle of the pole	Relative electric angle of encoder position and motor pole position. Setting range: 0.00–359.99°	0.00°	○
P24.11	Autotuning of initial angle of pole	0–3 0: No operation 1: Rotary autotuning (DC braking) 2: Static autotuning (suitable for resolver-type encoder, sin/cos with CD signal feedback) 3: Rotary autotuning (initial angle identification)	0	◎
P24.12	Speed measurement	0: No optimization 1: Optimization mode 1	1	◎

Function code	Name	Detailed parameter description	Default value	Modify
	optimization selection	2: Optimization mode 2		
P24.13	CD signal zero offset gain	0–65535	0	○
P24.14	Encoder type selection	Ones: Incremental encoder 0: without UVW 1: with UVW Tens: Sin/Cos encoder 0: without CD signal 1: with CD signal	0x00	◎
P24.15	Speed measurement mode	0: PG card 1: local; realized by HDIA and HDIB; supports incremental 24V encoder only	0	◎
P24.16	Frequency-division coefficient	0–255 When this parameter is set to 0 or 1, frequency division of 1:1 is implemented.	0	○
P24.17	Pulse filter processing	0x0000–0xFFFF Bit0: Enable/disable encoder input filter 0: No filter 1: Filter Bit1: Encoder signal filter mode 0: Self-adaptive filter 1: Use P24.18 filter parameters Bit2: Enable/disable encoder frequency-division output filter 0: No filter 1: Filter Bit3: Enable/disable pulse reference frequency-division output filter 0: No filter 1: Filter Bit4: Enable/disable pulse reference filter 0: No filter 1: Filter Bit5: Pulse reference filter mode 0: Self-adaptive filter 1: Use P24.19 filter parameters Bit6: Frequency-division output source setting (valid only for incremental encoders)	0x0033	○

Function code	Name	Detailed parameter description	Default value	Modify
		0: Encoder signals 1: Pulse reference signals Bits 7–15: Reserved		
P24.18	Encoder pulse filter width	0–63 The filtering time is P24.18×0.25 μs. The value 0 or 1 indicates 0.25 μs.	2	<input type="radio"/>
P24.19	Pulse reference filter width	0–63 The filtering time is P24.19×0.25 μs. The value 0 or 1 indicates 0.25 μs.	2	<input type="radio"/>
P24.20	Pulse number of pulse reference	0–16000	1024	<input checked="" type="radio"/>
P24.21	Enable angle compensation of synchronous motor	0–1	1	<input type="radio"/>
P24.22	Switchover frequency threshold of speed measurement mode	0.00Hz–P00.03	1.00Hz	<input type="radio"/>
P24.23	Synchronous motor angle compensation coefficient	-200.0→+200.0%	100.0%	<input type="radio"/>
P24.24	Number of pole pairs in initial magnetic pole angle autotuning	1–128	2	<input checked="" type="radio"/>
P24.25	SSI encoder type	0–1 0: Single-turn 1: Multi-turn	1	<input checked="" type="radio"/>
P24.26	SSI encoder single-turn resolution	0–20	14	<input type="radio"/>
P24.27	SSI encoder single-turn resolution (total)	0–20	12	<input type="radio"/>

**P25 group—Extension I/O card input functions**

Function code	Name	Detailed parameter description	Default value	Modify
P25.00	HDI3 input type selection	0: HDI3 is high-speed pulse input 1: HDI3 is digital input	0	☉
P25.01	S5 terminal function	The same as P05.01	0	☉
P25.02	S6 terminal function		0	☉
P25.03	S7 terminal function		0	☉
P25.04	S8 terminal function		0	☉
P25.05	S9 terminal function		0	☉
P25.06	S10 terminal function		0	☉
P25.07	HDI3 terminal function		0	☉
P25.08	Input terminal polarity of expansion card		0x00–0x7F (0: disable, 1: enable) BIT0: S5 virtual terminal BIT1: S6 virtual terminal BIT2: S7 virtual terminal BIT3: S8 virtual terminal BIT4: S9 virtual terminal BIT5: S10 virtual terminal BIT6: HDI3 virtual terminal	0x00
P25.09	Virtual terminal setting of expansion card	0x000–0x7F (0: disable, 1: enable) BIT0: S5 virtual terminal BIT1: S6 virtual terminal BIT2: S7 virtual terminal BIT3: S8 virtual terminal BIT4: S9 virtual terminal BIT5: S10 virtual terminal BIT6: HDI3 virtual terminal	0x00	☉
P25.10	HDI3 terminal switch-on delay	These function codes define corresponding delay of the programmable input terminals during level variation from switch-on to switch-off .	0.000s	○
P25.11	HDI3 terminal switch-off delay		0.000s	○
P25.12	S5 terminal		0.000s	○

Function code	Name	Detailed parameter description	Default value	Modify
	switch-on delay			
P25.13	S5 switch-off delay		0.000s	○
P25.14	S6 terminal switch-on delay	Setting range: 0.000–50.000s	0.000s	○
P25.15	S6 switch-off delay		0.000s	○
P25.16	S7 terminal switch-on delay		0.000s	○
P25.17	S7 switch-off delay		0.000s	○
P25.18	S8 terminal switch-on delay		0.000s	○
P25.19	S8 switch-off delay		0.000s	○
P25.20	S9 terminal switch-on delay		0.000s	○
P25.21	S9 switch-off delay		0.000s	○
P25.22	S10 terminal switch-on delay		0.000s	○
P25.23	S10 switch-off delay		0.000s	○
P25.24	Lower limit value of AI3	These function codes define the relation between analog input voltage and corresponding set value of analog input. When the analog input voltage exceeds the range of max./min. input, the max. input or min. input will be adopted during calculation. When analog input is current input, 0–20mA current corresponds to 0–10V voltage. In different application cases, 100% of the analog setting corresponds to different nominal values. The figure below illustrates several settings.	0.00V	○
P25.25	Corresponding setting of lower limit of AI3		0.0%	○
P25.26	Upper limit value of AI3		10.00V	○
P25.27	Corresponding setting of upper limit of AI3		100.0%	○
P25.28	Input filter time of AI3		0.030s	○
P25.29	Lower limit value of AI4		0.00V	○
P25.30	Corresponding		0.0%	○

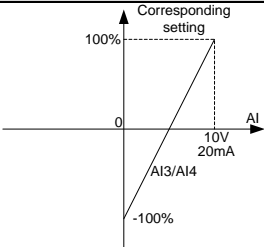
Function code	Name	Detailed parameter description	Default value	Modify
	setting of lower limit of AI4			
P25.31	Upper limit value of AI4		10.00V	<input type="radio"/>
P25.32	Corresponding setting of upper limit of AI4		100.0%	<input type="radio"/>
P25.33	Input filter time of AI4	<p>Input filter time: Adjust the sensitivity of analog input, increase this value properly can enhance the anti-interference capacity of analog variables; however, it will also degrade the sensitivity of analog input.</p> <p><b>Note:</b> AI3 and AI4 can support 0–10V/0–20mA input, when AI3 and AI4 select 0–20mA input, the corresponding voltage of 20mA is 10V.</p> <p>Setting range of P25.24: 0.00V–P25.26                      Setting range of P25.25: -300.0%–300.0%                      Setting range of P25.26: P25.24–10.00V                      Setting range of P25.27: -300.0%–300.0%                      Setting range of P25.28: 0.000s–10.000s                      Setting range of P25.29: 0.00V–P25.31                      Setting range of P25.30: -300.0%–300.0%                      Setting range of P25.31: P25.29–10.00V                      Setting range of P25.32: -300.0%–300.0%                      Setting range of P25.33: 0.000s–10.000s</p>	0.030s	<input type="radio"/>
P25.34	HDI3 high-speed pulse input function	0: Set input via frequency 1: Count	0	<input checked="" type="radio"/>
P25.35	Lower limit frequency of HDI3	0.000 kHz – P25.37	0.000 kHz	<input type="radio"/>
P25.36	Corresponding setting of lower limit frequency of HDI3	-300.0%–300.0%	0.0%	<input type="radio"/>
P25.37	Upper limit frequency of HDI3	P25.35–50.000kHz	50.000 kHz	<input type="radio"/>

Function code	Name	Detailed parameter description	Default value	Modify
P25.38	Corresponding setting of upper limit frequency of HDI3	-300.0%–300.0%	100.0%	<input type="radio"/>
P25.39	HDI3 frequency input filter time	0.000s–10.000s	0.030s	<input type="radio"/>
P25.40	AI3 input signal type	Range: 0–1 0: Voltage type 1: Current type	0	<input type="radio"/>
P25.41	AI4 input signal type	Range: 0–1 0: Voltage type 1: Current type	0	<input type="radio"/>
P25.42–P25.45	Reserved			

**P26 group—Output functions of expansion I/O card**

Function code	Name	Detailed parameter description	Default value	Modify
P26.00	HDO2 output type	0: Open collector high-speed pulse output 1: Open collector output	0	<input checked="" type="radio"/>
P26.01	HDO2 output selection	The same with P06.01	0	<input type="radio"/>
P26.02	Y2 output selection		0	<input type="radio"/>
P26.03	Y3 output selection		0	<input type="radio"/>
P26.04	Relay RO3 output selection		0	<input type="radio"/>
P26.05	Relay RO4 output selection		0	<input type="radio"/>
P26.06	Relay RO5 output selection		0	<input type="radio"/>
P26.07	Relay RO6 output selection		0	<input type="radio"/>
P26.08	Relay RO7 output selection		0	<input type="radio"/>
P26.09	Relay RO8 output selection		0	<input type="radio"/>



Function code	Name	Detailed parameter description	Default value	Modify
P26.10	Relay RO9 output selection		0	<input type="radio"/>
P26.11	Relay RO10 output selection		0	<input type="radio"/>
P26.12	Output terminal polarity of expansion card	0x0000–0x1FFF Bit0: Y2 Bit1: Y3 Bit2: HDO2 Bit3: RO3 Bit4: RO4 Bit5: RO5 Bit6: RO6 Bit7: RO7 Bit8: RO8 Bit9: RO9 Bit10: RO10 Bit11: RO11 Bit12: RO12	0x0000	<input type="radio"/>
P26.13	HDO2 switch-on delay	<p>Used to define the corresponding delay of the level variation from switch-on to switch-off.</p> <p>Setting range: 0.000–50.000s <b>Note:</b> P26.13 and P26.14 are valid only when P26.00 is set to 1.</p>	0.000s	<input type="radio"/>
P26.14	HDO2 switch-off delay		0.000s	<input type="radio"/>
P26.15	Y2 switch-on delay		0.000s	<input type="radio"/>
P26.16	Y2 switch-off delay		0.000s	<input type="radio"/>
P26.17	Y3 switch-on delay		0.000s	<input type="radio"/>
P26.18	Y3 switch-off delay		0.000s	<input type="radio"/>
P26.19	Relay RO3 switch-on delay		0.000s	<input type="radio"/>
P26.20	Relay RO3 switch-off delay		0.000s	<input type="radio"/>
P26.21	Relay RO4 switch-on delay		0.000s	<input type="radio"/>
P26.22	Relay RO4 switch-off delay		0.000s	<input type="radio"/>

Function code	Name	Detailed parameter description	Default value	Modify	
P26.23	Relay RO5 switch-on delay		0.000s	<input type="radio"/>	
P26.24	Relay RO5 switch-off delay		0.000s	<input type="radio"/>	
P26.25	Relay RO6 switch-on delay		0.000s	<input type="radio"/>	
P26.26	Relay RO6 switch-off delay		0.000s	<input type="radio"/>	
P26.27	Relay RO7 switch-on delay		0.000s	<input type="radio"/>	
P26.28	Relay RO7 switch-off delay		0.000s	<input type="radio"/>	
P26.29	Relay RO8 switch-on delay		0.000s	<input type="radio"/>	
P26.30	Relay RO8 switch-off delay		0.000s	<input type="radio"/>	
P26.31	Relay RO9 switch-on delay		0.000s	<input type="radio"/>	
P26.32	Relay RO9 switch-off delay		0.000s	<input type="radio"/>	
P26.33	Relay RO10 switch-on delay		0.000s	<input type="radio"/>	
P26.34	Relay RO10 switch-off delay		0.000s	<input type="radio"/>	
P26.35	AO2 output selection		Same as P06.14	0	<input type="radio"/>
P26.36	AO3 output selection			0	<input type="radio"/>
P26.37	Reserved				
P26.38	Lower limit of AO2 output	Above function codes define the relation between output value and analog output. When the output value exceeds the set max./min. output range, the upper/low limit of output will be adopted during calculation.  When analog output is current output, 1mA corresponds to 0.5V voltage. In different applications, 100% of output value corresponds to different analog outputs.	0.0%	<input type="radio"/>	
P26.39	Corresponding AO2 output of lower limit		0.00V	<input type="radio"/>	
P26.40	Upper limit of AO2 output		100.0%	<input type="radio"/>	
P26.41	Corresponding AO2 output of		10.00V	<input type="radio"/>	

Function code	Name	Detailed parameter description	Default value	Modify
	upper limit			
P26.42	AO2 output filter time		0.000s	<input type="radio"/>
P26.43	Lower limit of AO3 output		0.0%	<input type="radio"/>
P26.44	Corresponding AO3 output of lower limit		0.00V	<input type="radio"/>
P26.45	Upper limit of AO3 output		100.0%	<input type="radio"/>
P26.46	Corresponding AO3 output of upper limit		10.00V	<input type="radio"/>
P26.47	AO3 output filter time		0.000s	<input type="radio"/>
P26.48–P26.52	Reserved			

**P27 group—Programmable expansion card functions**

Function code	Name	Detailed parameter description	Default value	Modify
P27.00	Enabling programmable card	0–1 This function is reserved.	0	<input checked="" type="radio"/>
P27.01	C_WrP1	0–65535 Used to write a value to WrP1 of the programmable card.	0	<input type="radio"/>
P27.02	C_WrP2	0–65535 Used to write a value to WrP2 of the programmable card.	0	<input type="radio"/>
P27.03	C_WrP3	0–65535 Used to write a value to WrP3 of the programmable card.	0	<input type="radio"/>
P27.04	C_WrP4	0–65535 Used to write a value to WrP4 of the programmable card.	0	<input type="radio"/>
P27.05	C_WrP5	0–65535 Used to write a value to WrP5 of the	0	<input type="radio"/>

Function code	Name	Detailed parameter description	Default value	Modify
		programmable card.		
P27.06	C_WrP6	0-65535 Used to write a value to WrP6 of the programmable card.	0	<input type="radio"/>
P27.07	C_WrP7	0-65535 Used to write a value to WrP7 of the programmable card.	0	<input type="radio"/>
P27.08	C_WrP8	0-65535 Used to write a value to WrP8 of the programmable card.	0	<input type="radio"/>
P27.09	C_WrP9	0-65535 Used to write a value to WrP9 of the programmable card.	0	<input type="radio"/>
P27.10	C_WrP10	0-65535 Used to write a value to WrP10 of the programmable card.	0	<input type="radio"/>
P27.11	Programmable card status	0-1 Used to display the status of the programmable card. 0: Stopped 1: Running	0	<input checked="" type="radio"/>
P27.12	C_MoP1	0-65535 Used to monitor/view the MoP1 value of the programmable card.	0	<input checked="" type="radio"/>
P27.13	C_MoP2	0-65535 Used to monitor/view the MoP2 value of the programmable card.	0	<input checked="" type="radio"/>
P27.14	C_MoP3	0-65535 Used to monitor/view the MoP3 value of the programmable card.	0	<input checked="" type="radio"/>
P27.15	C_MoP4	0-65535 Used to monitor/view the MoP4 value of the programmable card.	0	<input checked="" type="radio"/>
P27.16	C_MoP5	0-65535 Used to monitor/view the MoP5 value of the programmable card.	0	<input checked="" type="radio"/>
P27.17	C_MoP6	0-65535 Used to monitor/view the MoP6 value of the	0	<input checked="" type="radio"/>

Function code	Name	Detailed parameter description	Default value	Modify
		programmable card.		
P27.18	C_MoP7	0–65535 Used to monitor/view the MoP7 value of the programmable card.	0	●
P27.19	C_MoP8	0–65535 Used to monitor/view the MoP8 value of the programmable card.	0	●
P27.20	C_MoP9	0–65535 Used to monitor/view the MoP9 value of the programmable card.	0	●
P27.21	C_MoP10	0–65535 Used to monitor/view the MoP10 value of the programmable card.	0	●
P27.22	Digital input terminal status of programmable card	0x00–0x3F Bit5–Bit0 indicate PS6–PS1 respectively.	0x00	●
P27.23	Digital output terminal status of programmable card	0x0–0x3 Bit0 indicates PRO1, and Bit1 indicates PRO2.	0x0	●
P27.24	AI1 of the programmable card	0–10.00V/0.00–20.00mA AI1 value from the programmable card.	0	●
P27.25	AO1 of programmable card	0–10.00V/0.00–20.00mA AO1 value from the programmable card.	0	●
P27.26	Length of data sent by programmable card and PZD communication object	0x00–0x28 Ones place: Quantity of data sent from the programmable card and VFD (that is, quantity of data sent from the programmable card + from VFD sending table 1 + from VFD sending table 2) 0: 0+24+60 1: 12+24+60 2: 24+24+60 3: 36+24+60 4: 48+24+60 5: 60+48+60	0x03	○

Function code	Name	Detailed parameter description	Default value	Modify
		6: 72+24+60 7: 84+24+60 8: 96+96+96 Tens place: Card that communicates with the programmable card through PZD (valid only when the ones place of P27.26 is 5) 0: DP card 1: CANopen card 2: PN card <b>Note:</b> P27.26 can be changed at any time, but the change will take effect only after the re-power on.		
P27.27	Programmable card save function at power failure	0-1 0: Disable 1: Enable	1	⊙

**P28 group—Master/slave control functions**

Function code	Name	Detailed parameter description	Default value	Modify
P28.00	Master/slave mode selection	0: The master/slave control is invalid 1: This machine is a master 2: This machine is a slave	0	⊙
P28.01	Master/slave communication data selection	0: CAN 1: Reserved	0	⊙
P28.02	Master/slave control mode	Ones: Master/slave running mode selection 0: Master/slave mode 0 (The master and slave adopt speed control and maintain the power balance by droop control) 1: Master/slave mode 1 (The master and slave must be in the same type of vector control mode. The master is speed control, and the slave will be forced to be in the torque control mode. 2: Master/slave mode 2 Start in the slave first speed mode (master/slave mode 0) and then switch to torque mode at a certain frequency point (master/slave mode 1) Tens: Slave start command source selection	0x001	⊙

Function code	Name	Detailed parameter description	Default value	Modify
		0: Follow the master to start 1: Determined by P00.01 Hundreds: Slave transmitting/master receiving data enable 0: Enable 1: Disable		
P28.03	Slave speed gain	0.0–500.0%	100.0%	○
P28.04	Slave torque gain	0.0–500.0%	100.0%	○
P28.05	Speed/torque mode switching frequency point in master/slave mode 2	0.00–10.00Hz	5.00Hz	○
P28.06	Slave count	1–15	1	◎
P28.07–P28.08	Reserved			
P28.09	CAN slave torque offset	-100.0–100.0%	0.0%	○
P28.10	Enabling EC PT100/PT1000 to detect temperature	0x00–0x11 Ones place: PT100 temperature detection 0: Disable 1: Enable Tens place: PT1000 temperature detection 0: Disable 1: Enable	0x00	◎
P28.11	EC PT100 detected OH protection threshold	Protection threshold of overheating (OH) detected by the expansion card (EC) with PT100. 0.0–150.0°C	120.0°C	○
P28.12	EC PT100 detected OH pre-alarm threshold	Pre-alarm threshold of OH detected by the EC with PT100. 0.0–150.0°C	100.0°C	○
P28.13	EC PT100 detected temperature calibration upper limit	Calibration upper limit of temperature detected by the EC with PT100. 50.0–150.0°C	120.0°C	○
P28.14	EC PT100 detected temperature	Calibration lower limit of temperature detected by the EC with PT100. -20.0–50.0°C	10.0°C	○

Function code	Name	Detailed parameter description	Default value	Modify
	calibration lower limit			
P28.15	EC PT100 calibration upper limit digital	0–4096	2950	○
P28.16	EC PT100 calibration lower limit digital	0–4096	1270	○
P28.17	EC PT1000 detected OH protection threshold	0.0–150.0°C	120.0°C	○
P28.18	EC PT1000 detected OH pre-alarm threshold	0.0–150.0°C	100.0°C	○
P28.19	PT1000 detected temperature calibration upper limit	50.0–150.0°C	120.0°C	○
P28.20	EC PT1000 detected temperature calibration lower limit	-20.0–50.0°C	10.0°C	○
P28.21	EC PT1000 calibration upper limit digital	0–4096	3100	○
P28.22	EC PT1000 calibration lower limit digital	0–4096	1100	○
P28.23	Detecting for PT100/PT1000 disconnection from EC	0x00–0x11 Ones place: PT100 disconnection detection 0: Disable 1: Enable Tens place: PT1000 disconnection detection 0: Disable 1: Enable	0x00	⊙
P28.24	Enabling digital calibration in EC PT100/PT1000	0–4 0: Disable 1: Enable PT100 lower limit digital calibration. 2: Enable PT100 upper limit digital calibration. 3: Enable PT1000 lower limit digital calibration.	0	○



Function code	Name	Detailed parameter description	Default value	Modify
	temperature detection	4: Enable PT1000 upper limit digital calibration.		
P28.25	Type of sensor for AI/AO card to detect motor temperature	0–4 0: No temperature sensor 1: PT100 2: PT1000 3: KTY84 4: PTC (Measuring resistance only) <b>Note:</b> Temperature is displayed through P19.21. This parameter is valid only when the temperature resistor connects to AO1 and AI1. To measure temperature, switch the output of AO1 to current, and connect one end of the temperature resistor to AI1 and AO1, and the other end to GND.	0	☉
P28.26	AI/AO detected motor OH protection threshold	0.0–200.0°C <b>Note:</b> When the motor temperature exceeds the threshold, the VFD releases the OT alarm.	110.0°C	○
P28.27	AI/AO detected motor OH pre-alarm threshold	0.0–200.0°C <b>Note:</b> When the motor temperature exceeds the value, the DO terminal with function 48 (AI detected motor OH pre-alarm) outputs a valid signal.	90.0°C	○
P28.28	AI/AO detected temperature calibration value	-200–200.0°C	0.0°C	○

**P90 group—Tension control in speed mode**

Function code	Name	Detailed parameter description	Default	Modify
P90.00	Tension control mode	0: Invalid 1: Speed mode 2: Open-loop torque mode 3: Closed-loop torque mode <b>Note:</b> The value 0 indicates tension control is invalid. Select a non-0 value to enable the tension control function.	0	☉
P90.01	Winding/unwinding mode	0: Winding 1: Unwinding <b>Note:</b> The motor forward rotation direction is the winding direction. When using the tension control mode, check whether the motor rotation direction is correct in the winding mode; if not, change the	0	○

Function code	Name	Detailed parameter description	Default	Modify
		rotation direction by swapping two phase wires of the motor. After the rotation direction is corrected, the winding mode can be switched to the unwinding mode by setting P90.01 to 1 or changing the winding/unwinding switchover terminals.		
P90.02	Reel mechanical transmission rate	0.01–600.00 =Motor rotation speed/Reel rotation speed=Reel diameter/Motor shaft diameter	1.00	○
P90.03	Max. linear speed	0.0–6000.0 m/min	1000.0 m/min	○
P90.04	Input source of linear speed	0: Keypad 1: AI1 2: AI2 3: AI3 4: High-speed pulse HDI 5: Main traction encoder frequency-division input	0	◎
P90.05	Linear speed set through keypad	0.0–100.0%	20.0%	○
P90.06	Diameter of main traction	0.0–6000.0mm	99.0mm	○
P90.07	Main traction drive ratio	0.000–60.000	1.000	○
P90.08	Linear speed ACC time	0.00–600.00s	0.00s	○
P90.09	Linear speed DEC time	0.00–600.00s	0.00s	○
P90.10	Tension setting	0x00–0x14 Ones place: Tension setting source 0: Keypad 1: AI1 2: AI2 3: AI3 4: High-speed pulse HDI Tens place: Multiplier of max. tension (P90.12) 0: 1 1: 10	0x00	◎
P90.11	Tension set	0.0–100.0%	10.0%	○

Function code	Name	Detailed parameter description	Default	Modify
	through keypad			
P90.12	Max. tension	When the tens place of P90.10 is 0, the setting range is 0–60000N. When the tens place of P90.10 is 1, the setting range is (0–60000)*10N.	1000N	○
P90.13	Roll diameter calculation mode	0: Not calculated 1: AI1 2: AI2 3: AI3 4: High-speed pulse HDI 5: Linear speed 6: Thickness (of wire) 7: Thickness (of strip)	0	◎
P90.14	Roll diameter calculation delay time	0.0–100.0s	1.0s	○
P90.15	Min. roll diameter	0.0mm–P90.16	50.0mm	○
P90.16	Max. roll diameter	P90.15–5000.0mm	1000.0 mm	○
P90.17	Initial roll diameter 1	P90.15–P90.16 (mm)	100.0 mm	○
P90.18	Initial roll diameter 2	P90.15–P90.16 (mm)	100.0 mm	○
P90.19	Initial roll diameter 3	P90.15–P90.16 (mm)	100.0 mm	○
P90.20	Linear speed roll diameter calculation filter time	0.000–60.000s	2.000s	○
P90.21	Linear speed roll diameter calculation restriction	0x00–0x11 Ones place: 0:No 1: Restrict changes in reverse direction Tens place: 0: No 1: Automatic restriction according to running frequency and material thickness	0x00	○
P90.22	Material	0.001–65.535mm	0.010	○

Function code	Name	Detailed parameter description	Default	Modify
	thickness		mm	
P90.23	Number of coils per layer	1–10000	1	☉
P90.24	Revolution counting function selection	0–2 0: Digital terminal input 1: PG card input (Applicable to thickness calculation method) 2: Running frequency (No input automatic revolution counting)	0	☉
P90.25	Number of pulses per revolution	1–60	1	☉
P90.26	Roll diameter set value	0.0–100.0%	80.0%	○
P90.27	Roll diameter reset setting	0x0000–0x1111 Ones place: At stop 0: Remain current roll diameter 1: Restore to initial roll diameter Tens place: Power off at running 0: Remain current roll diameter 1: Restore to initial roll diameter Hundreds place: Reach the roll diameter set value 0: Remain current roll diameter 1: Restore to initial roll diameter Thousands place: Terminal reset limitation 0: Reset allowed at running 1: Reset only allowed at stop	0x1000	○
P90.28	Tension PID output reference	0–1 0: Max. value 1: Given value	0	○
P90.29	Tension PID parameter source	0–5 0: First group of P90 1: Roll diameter (max. roll diameter) 2: Main reference frequency (max. Frequency) 3: Running linear speed (max. linear speed) 4: Deviation (Reference 100%) 5: Terminal	0	○
P90.30	Group 1 proportional gain	0.000–30.000	0.030	○

Function code	Name	Detailed parameter description	Default	Modify
P90.31	Group 1 integral time	0.00–30.00s	5.00s	○
P90.32	Group 1 differential time	0.00–10.00s	0.00s	○
P90.33	Group 2 proportional gain	0.000–30.000	0.030	○
P90.34	Group 2 integral time	0.00–30.00s	5.00s	○
P90.35	Group 2 differential time	0.00–10.00s	0.00s	○
P90.36	PID parameter adjustment reference point 1	0.0%–P90.37	10.0%	○
P90.37	PID parameter adjustment reference point 2	P90.36–100.0%	50.0%	○
P90.38	Min. frequency for roll diameter calculation	0.00–50.00Hz	0.30Hz	○
P90.39	Min. linear speed for roll diameter calculation	0.0–100.0%	3.0%	○

**P91 group—Tension control in torque mode**

Function code	Name	Detailed parameter description	Default	Modify
P91.00	Tension control zero speed reference	0–1 0: Max. linear speed 1: Reserved	0	◎
P91.01	Tension control zero speed threshold	0.0–50.0%	0.5%	○
P91.02	Zero speed offset	0.0–50.0%	2.0%	○
P91.03	Upper-limit frequency source of torque control	0–3 0: P03.14, P03.15 1: Forward rotation limit set by line speed 2: Reverse rotation limit set by line speed 3: Forward and reverse rotations limit set by line speed	3	◎

Function code	Name	Detailed parameter description	Default	Modify
P91.04	Running frequency upper limit offset of tension control	0.0–100.0%	5.0%	<input type="radio"/>
P91.05	Differential separation threshold	0.0–100.0%	5.0%	<input type="radio"/>
P91.06	PID restricts reverse limit at zero speed	0–1 0: Enable 1: Disable	0	<input checked="" type="radio"/>
P91.07	Torque compensation selection	0x000–0x111 Ones place: Frictional torque compensation 0: No 1: Yes Tens place: Inertia compensation 0: No 1: Yes Hundreds place: Compensation direction 0: In line with torque direction 1: Different from torque direction	0x000	<input checked="" type="radio"/>
P91.08	System mechanical parameters identification	0–2 0: No operation 1: Enable system mechanical inertia identification 2: Enable mechanical friction torque identification	0	<input checked="" type="radio"/>
P91.09	Static friction torque compensation coefficient	0.0–100.0%	0.0%	<input type="radio"/>
P91.10	Sliding friction torque compensation coefficient 1	0.0–100.0%	0.0%	<input type="radio"/>
P91.11	Sliding friction torque compensation coefficient 2	0.0–100.0%	0.0%	<input type="radio"/>
P91.12	Sliding friction torque compensation	0.0–100.0%	0.0%	<input type="radio"/>

Function code	Name	Detailed parameter description	Default	Modify
	coefficient 3			
P91.13	High speed torque compensation coefficient	0.0–100.0%	0.0%	○
P91.14	Compensation frequency point of static friction torque	0.0%–P91.15	1.0%	○
P91.15	Compensation frequency point of sliding friction torque 1	P91.14–P91.16 (%)	20.0%	○
P91.16	Compensation frequency point of sliding friction torque 2	P91.15–P91.17 (%)	50.0%	○
P91.17	Compensation frequency point of sliding friction torque 3	P91.16–P91.18 (%)	80.0%	○
P91.18	High-speed friction torque compensation frequency point	P91.17–100.0%	100.0%	○
P91.19	ACC/DEC frequency source	0–1 0: Linear speed 1: Running frequency	0	◎
P91.20	Material density	0–30000kg/m <sup>3</sup>	0 kg/m <sup>3</sup>	○
P91.21	Reel width	0.000–60.000m	0.000m	○
P91.22	ACC inertia compensation coefficient	0.0–100.0%	10.0%	○
P91.23	DEC inertia compensation coefficient	0.0–100.0%	10.0%	○
P91.24	Tension taper coefficient source	0–4 0: Keypad	0	◎

Function code	Name	Detailed parameter description	Default	Modify
		1: AI1 2: AI2 3: AI3 4: High-speed pulse HDI		
P91.25	Tension taper set through keypad	0.0–100.0%	30.0%	<input type="radio"/>
P91.26	Tension taper compensation correction	0.0–5000.0mm	0.0mm	<input type="radio"/>
P91.27	Tension taper curve selection	0–1 0: Inverse proportional curve 1: Multi-point curve	0	<input checked="" type="radio"/>
P91.28	Roll diameter value 1	0.0–5000.0mm	200.0 mm	<input type="radio"/>
P91.29	Tension taper coefficient for roll diameter value 1	0.0–50.0%	3.0%	<input type="radio"/>
P91.30	Roll diameter value 2	0.0–5000.0mm	500.0 mm	<input type="radio"/>
P91.31	Tension taper coefficient for roll diameter value 2	0.0–50.0%	7.0%	<input type="radio"/>
P91.32	Tension offset value at zero speed	0.0–300.0%	0.0%	<input type="radio"/>
P91.33	Present roll diameter setting	0.0–5000.0mm	0.0mm	<input checked="" type="radio"/>

**P92 group—Customized tension control functions**

Function code	Name	Detailed parameter description	Default	Modify
P92.00	Pre-drive speed gain	0.0–100.0%	100.0%	<input type="radio"/>
P92.01	Pre-drive torque limit	0–2 0: Set based on P03.20, P03.21 1: Set based on P93.02 2: Set based on the set tension	2	<input type="radio"/>
P92.02	Pre-drive torque limit setting	0.0–200.0%	100.0%	<input type="radio"/>



Function code	Name	Detailed parameter description	Default	Modify
P92.03	Zero bit conversion enabling	0–1 0: Disable 1: Enable	0	☉
P92.04	Initial zero bit	0.0–100.0%	10.0%	○
P92.05	Final zero bit	0.0–100.0%	50.0%	○
P92.06	Conversion time from initial zero bit to final zero bit	0.00–60.00s	5.00s	○
P92.07	Conversion time from final zero bit to initial zero bit	0.00–60.00s	5.00s	○
P92.08	Feeding interrupt detection mode	0–3 0: Not detect 1: Detect based on digital value 2: Detect based on roll diameter calculation value 3: Detect based on feedback position	0	○
P92.09	Feeding interrupt detection start delay time	0.0–200.0s	20.0s	○
P92.10	Frequency lower limit of feeding interrupt detection	0.00–300.00Hz	10.00Hz	○
P92.11	Error range of feeding interrupt detection	0.1–50.0%	10.0%	○
P92.12	Determination delay time of feeding interrupt detection	0.1–60.0s	1.0s	○
P92.13	Handling mode of feeding interrupt	0x000–0x111 Ones place: Stop mode 0: Decelerate to stop in emergency manner 1: Coast to stop Tens place: Alarm mode 0: Stop in specified mode without reporting alarms 1: Report an alarm and coast to stop	0x000	☉

Function code	Name	Detailed parameter description	Default	Modify
		Hundreds place: Roll diameter memory function of feeding interrupt 0: Disable 1: Enable		
P92.14	Stop braking frequency	0.00–300.00Hz	1.50Hz	○
P92.15	Stop braking time	0.0–600.0s	0.0s	○

**P93 group—Tension control status viewing**

Function code	Name	Detailed parameter description	Default	Modify
P93.00	Actual control mode	0–3 0: Invalid tension control 1: Close-loop tension speed control 2: Open loop tension torque control 3: Close-loop tension torque control	0	●
P93.01	Actual winding/unwinding mode	0–1 0: Winding 1: Unwinding	0	●
P93.02	Initial roll diameter	0.0–5000.0mm	0.0mm	●
P93.03	Reset roll diameter	0.0–5000.0mm	0.0mm	●
P93.04	Roll diameter change rate	0.00–655.35 mm/s	0.00 mm/s	●
P93.05	Present roll diameter	0.0–5000.0mm	0.0mm	●
P93.06	Roll diameter for linear speed calculation	0.0–5000.0mm	0.0mm	●
P93.07	Set linear speed	0.0–6000.0 m/min	0.0 m/min	●
P93.08	Present linear speed	0.0–6000.0 m/min	0.0 m/min	●
P93.09	Main reference frequency	0.00Hz–P00.03	0.00Hz	●
P93.10	Actual proportional gain	0.00–30.00	0.00	●
P93.11	Actual integral	0.00–30.00s	0.00s	●

Function code	Name	Detailed parameter description	Default	Modify
	time			
P93.12	Proportional output value	0–65535	0	●
P93.13	Integral output value	0–65535	0	●
P93.14	PID upper limit	-100.0–100.0%	0.0%	●
P93.15	PID lower limit	-100.0–100.0%	0.0%	●
P93.16	PID output frequency	-99.99–99.99Hz	0.00Hz	●
P93.17	Main traction running frequency	-300.0–300.0Hz	0.0Hz	●
P93.18	Set tension	0–30000N	0N	●
P93.19	Tension taper coefficient	0.0–100.0%	0.0%	●
P93.20	Actual tension	0–30000N	0N	●
P93.21	Basic torque reference value	-300.0–300.0%	0.0%	●
P93.22	Friction compensation torque value	-300.0–300.0%	0.0%	●
P93.23	System rotational inertia	0.00–655.35 kg.m <sup>2</sup>	0.00 kg.m <sup>2</sup>	●
P93.24	Frequency change rate	-99.99–327.67 Hz/s	0.00 Hz/s	●
P93.25	Torque compensation value of system rotational inertia	-300.0–300.0%	0.0%	●
P93.26	Reference value after torque compensation	-300.0–300.0%	0.0%	●
P93.27	PID output torque	-300.0–300.0%	0.0%	●
P93.28	Final output torque	-300.0–300.0%	0.0%	●
P93.29	Measured tension	0–30000N	0 N	●

Function code	Name	Detailed parameter description	Default	Modify
P93.30	Number of material turns on the reel	-100–32767	0	●
P93.31	Length of material on the reel	0–65535m	0m	●
P93.32	Length increment	0.0–6553.5m	0.0m	●

## 7 Troubleshooting

### 7.1 What this chapter contains

The chapter tells how to reset faults and check faults history. A complete list of alarms and fault information as well as possible causes and corrective measures are presented in this chapter.

	<p>⚡ Only well-trained and qualified professionals are allowed to carry out the work described in this chapter. Operations should be carried out according to the instructions presented in chapter 1 "Safety precautions".</p>
---	---

### 7.2 Indications of alarms and faults

The fault is indicated by indicators (refer to section 5.4 Operating the VFD through the keypad). When the **TRIP** indicator is on, the alarm or fault code displayed in the keypad indicates the VFD is in exception state. This chapter covers most of the alarms and faults, and their possible causes and corrective measures.

### 7.3 Fault reset

You can reset the VFD via **STOP/RST** key on the keypad, digital inputs, or by cutting off the VFD power. After faults are removed, the motor can be start again.

### 7.4 Fault history

P07.27–P07.32 record the six latest fault types; P07.33–P07.40, P07.41–P07.48, and P07.49–P07.56 record the running data of the VFD when the latest three faults occurred.

### 7.5 VFD faults and solutions

When fault occurred, process the fault as shown below.

1. When VFD fault occurred, confirm whether keypad display is improper.
2. If keypad works properly, check the function codes in P07 group to confirm the corresponding fault record parameters, and determine the real state when current fault occurred through parameters;
3. Check the table below to see whether corresponding exception states exist based on the corresponding corrective measures;
4. Rule out the faults or ask for help from professionals;
5. After confirming faults are removed, reset the fault and start running.

#### 7.5.1 Details of faults and solutions

**Note:** The numbers enclosed in square brackets such as [1], [2] and [3] in the **Fault type** column in the following table indicate the VFD fault type codes read through communication.

Fault code	Fault type	Possible cause	Corrective measures
OUt1	[1] Inverter unit phase-U protection	Acceleration is too fast; IGBT module is damaged;	Increase acceleration time; Replace the power unit;
OUt2	[2] Inverter unit phase-V protection	Misacts caused by interference; drive wires are	Check drive wires; Check whether there is strong
OUt3	[3] Inverter unit	poorly connected ;	interference surrounds the

Fault code	Fault type	Possible cause	Corrective measures
	phase-W protection	To-ground short circuit occurs	peripheral equipment
OV1	[7] Over-voltage during acceleration	Exception occurred to input voltage; Large energy feedback; Lack of braking units; Dynamic braking is not enabled	Check input power;
OV2	[8] Over-voltage during deceleration		Check whether load deceleration time is too short; or the motor starts during rotating;
OV3	[9] Over-voltage during constant speed running		Install dynamic braking units; Check the setting of related function codes
OC1	[4] Over-current during acceleration	Acceleration is too fast; Grid voltage is too low; VFD power is too small; Load transient or exception occurred; To-ground short circuit or output phase loss occur; Strong external interference sources; Overvoltage stall protection is not enabled	Increase acceleration /deceleration time;
OC2	[5] Over-current during deceleration		Check input power;
OC3	[6] Over-current during constant speed running		Select the VFD with larger power; Check if the load is short circuited (to-ground short circuit or line-to-line short circuit) or the rotation is not smooth; Check the output wiring; Check if there is strong interference; Check the setting of related function codes.
UV	[10] Bus undervoltage fault	Grid voltage is too low; Overvoltage stall protection is not enabled	Check grid input power; Check the setting of related function codes
OL1	[11] Motor overload	Grid voltage is too low; Rated motor current is set improperly; Motor stall or load jumps violently	Check grid voltage; Reset rated motor current; Check the load and adjust torque boost
OL2	[12] VFD overload	Acceleration is too fast; The motor in rotating is restarted; Grid voltage is too low; Load is too large; Power is too small;	Increase acceleration time; Avoid restart after stop; Check grid voltage; Select the VFD with larger power; Select proper motor

Fault code	Fault type	Possible cause	Corrective measures
SPI	[13] Phase loss on input side	Phase loss or violent fluctuation occurred to R, S and T input	Check the input power; Check installation wiring
SPO	[14] Phase loss on output side	Phase loss occurred to U, V, W output (or the three phases of motor is asymmetrical)	Check the output wiring; Check the motor and cable
OH1	[15] Overheat of rectifier module	Air duct is blocked or fan is damaged;	Ventilate the air duct or replace the fan; Lower the ambient temperature
OH2	[16] Overheat of VFD module	Ambient temperature is too high; Long-time overload running	
EF	[17] External fault	SI external fault input terminal acts	Check external device input
CE	[18] Modbus/Modbus TCP communication fault	Baud rate is set improperly; Communication line fault; Communication address error; Communication suffers from strong interference	Set proper baud rate; Check the wiring of communication interfaces; Set proper communication address; Replace or change the wiring to enhance anti-interference capacity
ItE	[19] Current detection fault	Poor contact of the connector of control board; Hall component is damaged; Exception occurred to amplification circuit	Check the connector and re-plug; Replace the hall component; Replace the main control board
tE	[20] Motor autotuning fault	Motor capacity does not match with the VFD capacity, this fault may occur easily if the difference between them is exceeds five power classes; Motor parameter is set improperly; The parameters gained from autotuning deviate sharply from the standard parameters;	Change the VFD model, or adopt V/F mode for control; Set proper motor type and nameplate parameters; Empty the motor load and carry out autotuning again; Check motor wiring and parameter setting; Check whether upper limit frequency is larger than 2/3 of the rated frequency

Fault code	Fault type	Possible cause	Corrective measures
		Autotuning timeout	
EEP	[21] EEPROM fault	R/W error occurred to the control parameters; EEPROM is damaged	Press <b>STOP/RST</b> to reset; Replace the main control board
PIDE	[22] PID feedback offline fault	PID feedback offline; PID feedback source disappears;	Check PID feedback signal wires; Check PID feedback source
bCE	[23] Braking unit fault	Braking circuit fault or braking tube is damaged; The resistance of external braking resistor is too small	Check the braking unit, replace with new braking tubes; Increase braking resistance
END	[24] Running time is up	The actual running time of the VFD is larger than the set running time	Ask help from the supplier, adjust the set running time
OL3	[25] Electronic overload fault	The VFD releases overload pre-alarm based on the set value	Check the load and overload pre-alarm threshold
PCE	[26] Keypad communication fault	The keypad wire is poorly contacted or disconnected; The keypad wire is too long and suffers strong interference; Circuit fault occurred to the keypad or communication part of the main board	Check the keypad wires to confirm whether fault exists; Check the surroundings to rule out interference source; Replace the hardware and ask for maintenance service
UPE	[27] Parameter upload error	The keypad wire is poorly contacted or disconnected; The keypad wire is too long and suffers strong interference; Circuit fault occurred to the keypad or communication part of the main board	Check the surroundings to rule out interference source; Replace the hardware and ask for maintenance service; Replace the hardware and ask for maintenance service
DNE	[28] Parameter download error	The keypad wire is poorly contacted or disconnected; The keypad wire is too long and suffers strong interference;	Check the surroundings to rule out interference source; Replace the hardware and ask for maintenance service; Re-backup keypad data



Fault code	Fault type	Possible cause	Corrective measures
		Data storage error occurred to the keypad	
ETH1	[32] To-ground short circuit fault 1	VFD output is short connected to the ground; Current detection circuit is faulty; Actual motor power setting deviates sharply from the VFD power	Check whether motor wiring is proper; Replace the hall component; Replace the main control board; Reset the motor parameters properly
ETH2	[33] To-ground short circuit fault 1	VFD output is short connected to ground; Current detection circuit is faulty; Actual motor power setting deviates sharply from the VFD power	Check whether motor wiring is proper; Replace the hall component; Replace the main control board; Reset the motor parameters properly
dEu	[34] Speed deviation fault	Load is too heavy, or stall occurred	Check the load to ensure it is proper, increase the detection time; Check whether control parameters are set properly
STo	[35] Maladjustment fault	Control parameters of synchronous motor is set improperly; The parameter gained from autotuning is inaccurate; The VFD is not connected to motor	Check the load to ensure it is proper; Check whether load is proper; Check whether control parameters are set correctly; Increase maladjustment detection time
LL	[36] Electronic underload fault	The VFD performs underload pre-alarm based on the set value	Check the load and overload pre-alarm threshold
ENC1o	[37] Encoder offline fault	Encoder line sequence is wrong, or signal wires are poorly connected	Check the encoder wiring
ENC1d	[38] Encoder reversal fault	The encoder speed signal is contrary to the motor running direction	Reset encoder direction
ENC1Z	[39] Encoder Z pulse offline fault	Z signal wires are disconnected	Check the wiring of Z signal

Fault code	Fault type	Possible cause	Corrective measures
OT	[59] Motor over-temperature fault	Motor over-temperature input terminal is valid; Exception occurred to t temperature detection Exception occurred to resistor; Long-time overload running or exception occurred	Check the wiring of motor over-temperature input terminal (terminal function 57); Check whether temperature sensor is proper; Check the motor and perform maintenance on the motor
STO	[40] Safe torque off	Safe torque off function is enabled by external forces	/
STL1	[41] Exception occurred to safe circuit of channel H1	The wiring of STO is improper; Fault occurred to external switch of STO; Hardware fault occurred to safety circuit of channel H1	Check whether terminal wiring of STO is proper and firm enough; Check whether external switch of STO can work properly; Replace the control board
STL2	[42] Exception occurred to channel H2 safe circuit	The wiring of STO is improper; Fault occurred to external switch of STO; Hardware fault occurred to safety circuit of channel H2	Check whether terminal wiring of STO is proper and firm enough; Check whether external switch of STO can work properly; Replace the control board
STL3	[43] Exception occurred to channel H1 and channel H2	Hardware fault occurred to STO circuit	Replace the control board
CrCE	[44] Safety code FLASH CRC check fault	Control board is faulty	Replace the control board
E-Err	[55] Repetitive expansion card type	The two inserted expansion cards are of the same type	You should not insert two cards with the same type; check the type of expansion card, and remove one card after power down
ENCUV	[56] Encoder UVW loss fault	No electric level variation occurred to UVW signal	Check the wiring of UVW; Encoder is damaged
F1-Er	[60] Failed to identify the expansion card in card slot 1	There is data transmission in interfaces of card slot 1, however, it cannot read the card type	Confirm whether the expansion card inserted can be supported; Stabilize the expansion card

Fault code	Fault type	Possible cause	Corrective measures
			interfaces after power down, and confirm whether fault still occurs at next power-on; Check whether the insertion port is damaged, if yes, replace the insertion port after power down
F2-Er	[61] Failed to identify the expansion card in card slot 2	There is data transmission in interfaces of card slot 2, however, it cannot read the card type	Confirm whether the expansion card inserted can be supported; Stabilize the expansion card interfaces after power down, and confirm whether fault still occurs at next power-on; Check whether the insertion port is damaged, if yes, replace the insertion port after power down
F3-Er	[62] Failed to identify the expansion card in card slot 3	There is data transmission in interfaces of card slot 3, however, it cannot read the card type	Confirm whether the expansion card inserted can be supported; Stabilize the expansion card interfaces after power down, and confirm whether fault still occurs at next power-on; Check whether the insertion port is damaged, if yes, replace the insertion port after power down
C1-Er	[63] Communication timeout occurred to the expansion card in card slot 1	There is no data transmission in interfaces of card slot 1	Confirm whether the expansion card inserted can be supported; Stabilize the expansion card interfaces after power down, and confirm whether fault still occurs at next power-on; Check whether the insertion port is damaged, if yes, replace the insertion port after power

Fault code	Fault type	Possible cause	Corrective measures
			down
C2-Er	[64] Communication timeout occurred to the expansion card in card slot 2	There is no data transmission in interfaces of card slot 2	Confirm whether the expansion card inserted can be supported; Stabilize the expansion card interfaces after power down, and confirm whether fault still occurs at next power-on; Check whether the insertion port is damaged, if yes, replace the insertion port after power down
C3-Er	[65] Communication timeout occurred to the expansion card in card slot 3	There is no data transmission in interfaces of card slot 3	Confirm whether the expansion card inserted can be supported; Stabilize the expansion card interfaces after power down, and confirm whether fault still occurs at next power-on; Check whether the insertion port is damaged, if yes, replace the insertion port after power down
E-NET	[30] Ethernet card communication timeout fault	There is no data transmission between the communication card and the host computer	Check whether the communication card wiring is loose or dropped
E-CAN	[31] CANopen card communication timeout fault	There is no data transmission between the communication card and the host computer (or PLC)	Check whether the communication card wiring is loose or dropped
E-PN	[57] PROFINET card communication timeout fault	There is no data transmission between the communication card and the host computer (or PLC)	Check whether the communication card wiring is loose or dropped
E-CAT	[66] EtherCAT card communication timeout fault	There is no data transmission between the communication card and the	Check whether the communication card wiring is loose or dropped

Fault code	Fault type	Possible cause	Corrective measures
		host computer (or PLC)	
SECAN	[58] CAN master/slave communication card communication timeout fault	There is no data transmission between the CAN master and slave communication cards	Check whether the communication card wiring is loose or dropped
S-Err	[69] CAN slave fault in master/slave synchronization	Fault occurred to one of the CAN slave VFDs	Detect the CAN slave VFD and analyze the corresponding fault cause of the VFD

7.5.2 Other state

Displayed code	State type	Possible cause	Solution
PoFF	System power failure	The system is powered off or the bus voltage is too low.	Check the grid conditions.

7.6 Analysis on common faults

7.6.1 Motor fails to work

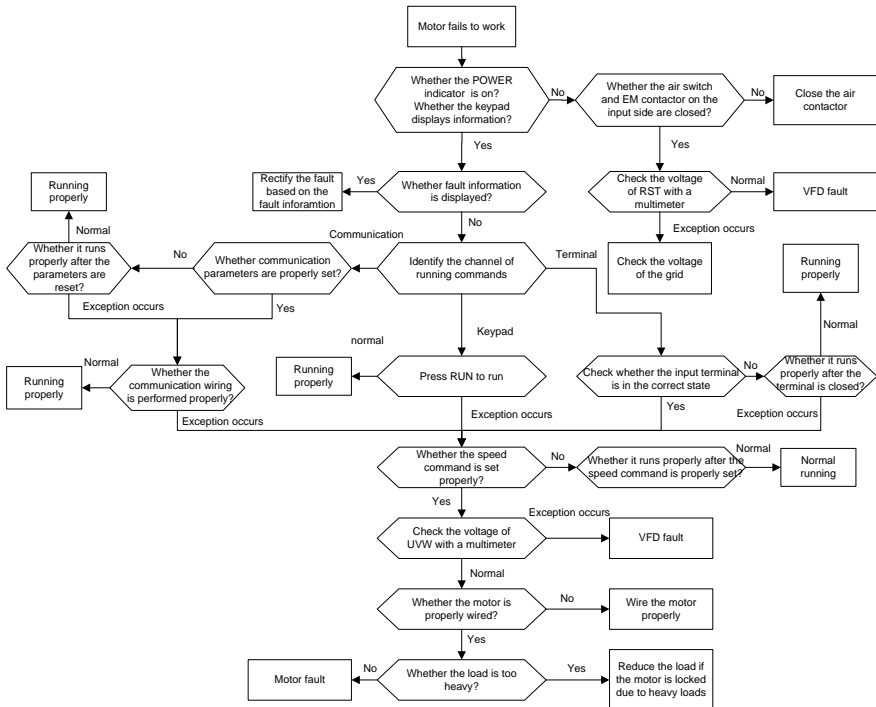

7.6.2 Motor vibrates

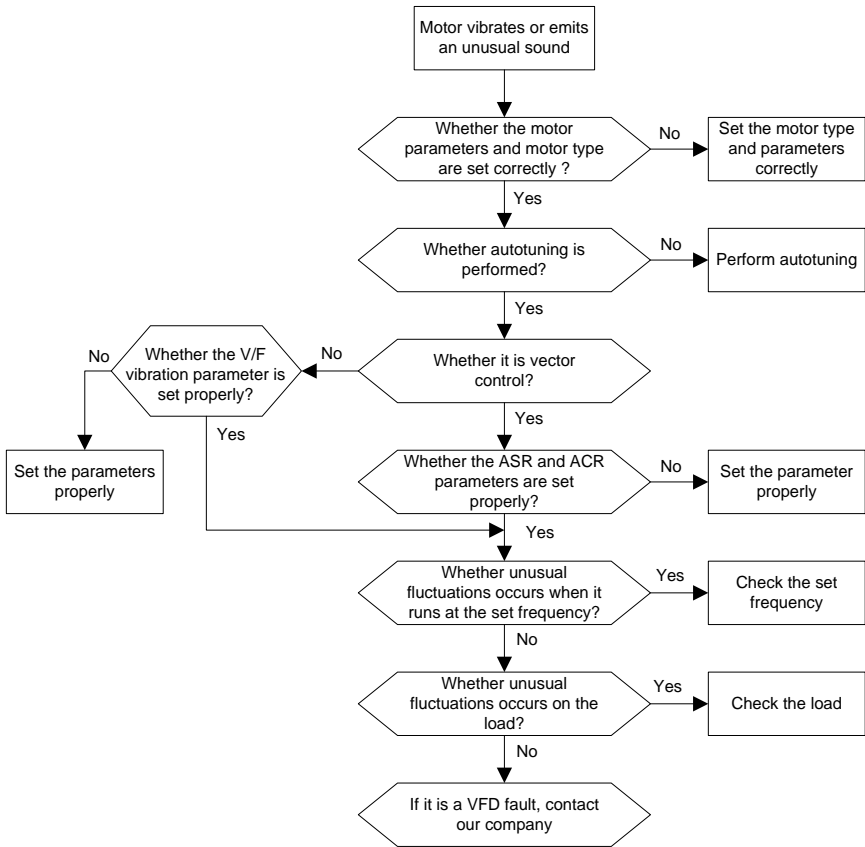

7.6.3 Overvoltage

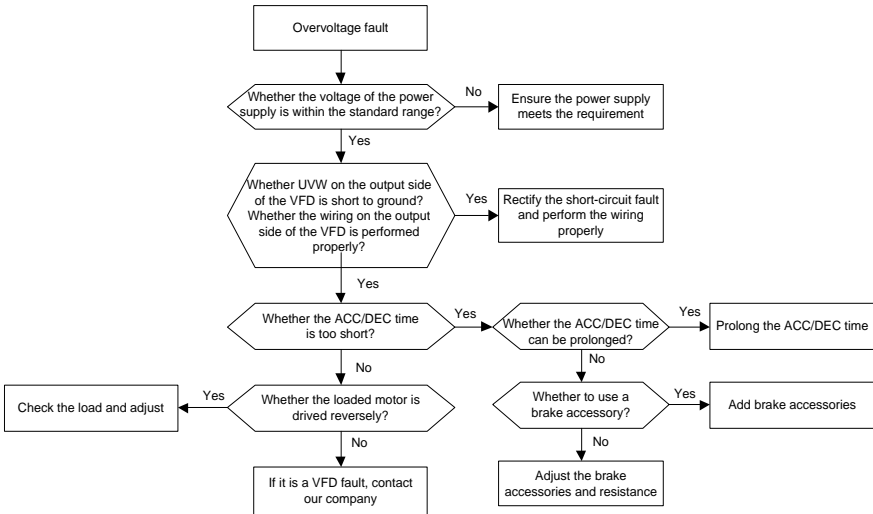

7.6.4 Undervoltage

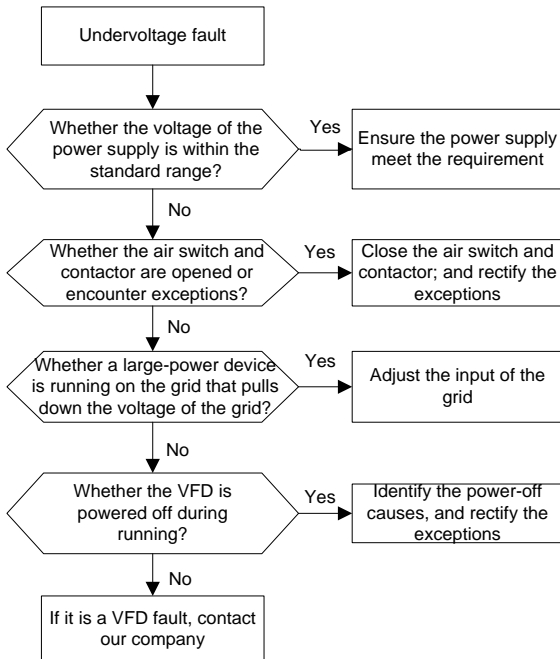

### 7.6.5 Unusual heating of motor

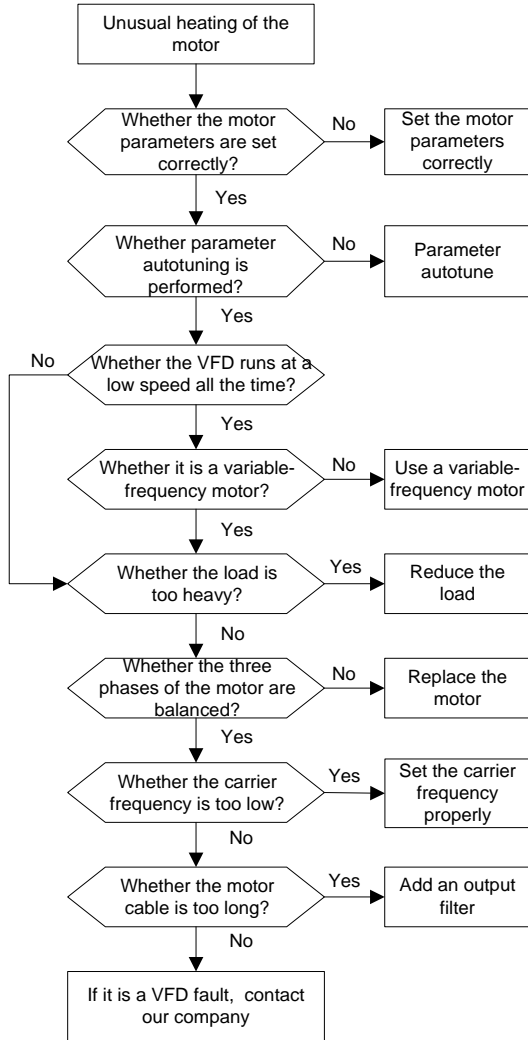



7.6.6 VFD overheating

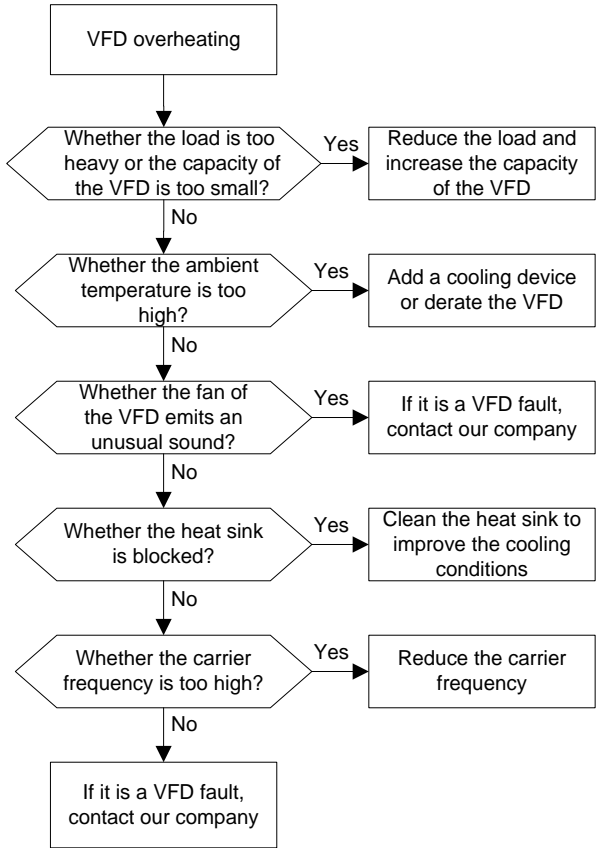

7.6.7 Motor stalls during ACC

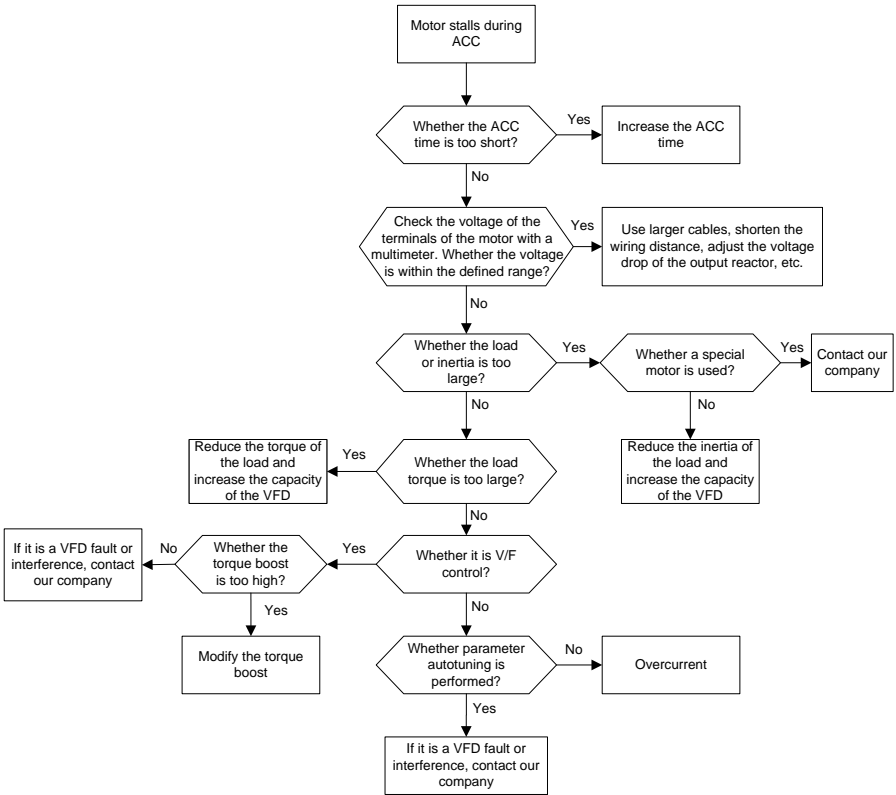

7.6.8 Overcurrent

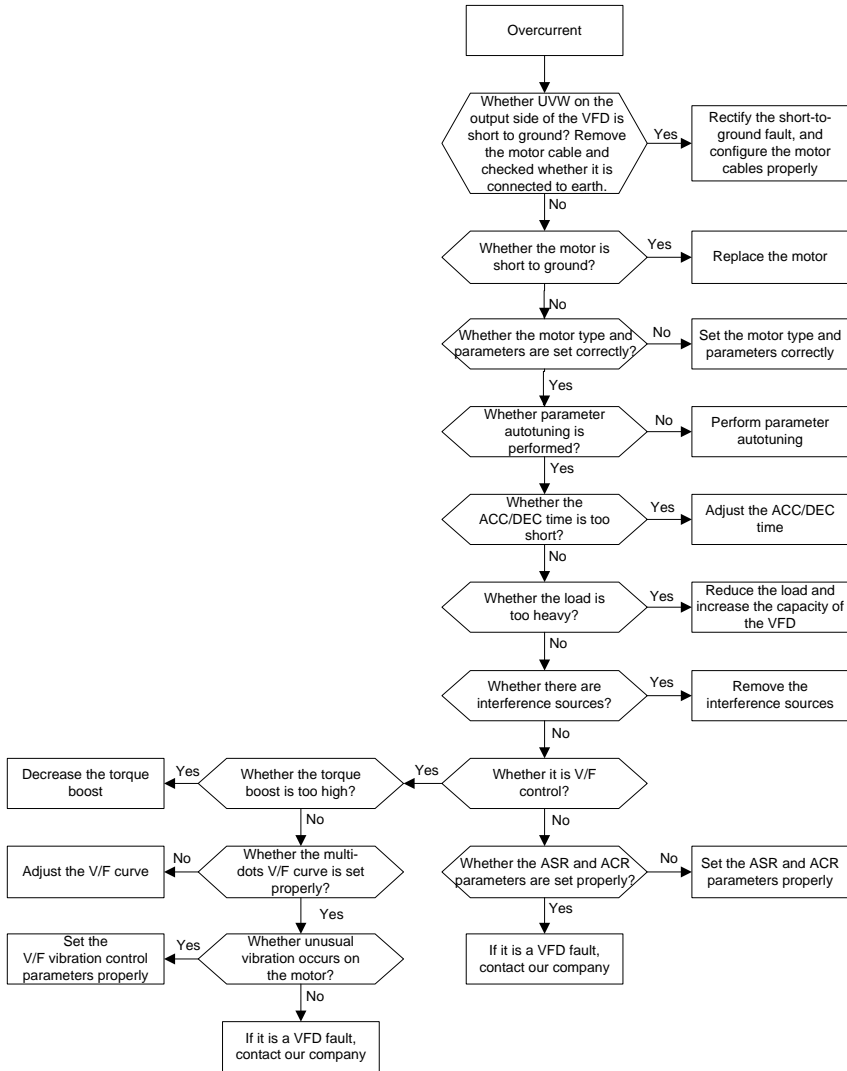

## 7.7 Countermeasures on common interference

### 7.7.1 Interference on meter switches and sensors

#### Interference phenomenon

Pressure, temperature, displacement, and other signals of a sensor are collected and displayed by a human-machine interaction device. The values are incorrectly displayed as follows after the VFD is started:

1. The upper or lower limit is wrongly displayed, for example, 999 or -999.
2. The display of values jumps (usually occurring on pressure transmitters).
3. The display of values is stable, but there is a large deviation, for example, the temperature is dozens of degrees higher than the common temperature (usually occurring on thermocouples).
4. A signal collected by a sensor is not displayed but functions as a drive system running feedback signal. For example, a VFD is expected to decelerate when the upper pressure limit of the compressor is reached, but in actual running, it starts to decelerate before the upper pressure limit is reached.
5. After a VFD is started, the display of all kinds of meters (such as frequency meter and current meter) that are connected to the analog output (AO) terminal of the VFD is severely affected, displaying the values incorrectly.
6. Proximity switches are used in the system. After a VFD is started, the indicator of a proximity switch flickers, and the output level flips.

#### Solution

1. Check and ensure that the feedback cable of the sensor is 20 cm or farther away from the motor cable.
2. Check and ensure that the ground wire of the motor is connected to the PE terminal of the VFD (if the ground wire of the motor has been connected to the ground block, you need to use a multimeter to measure and ensure that the resistance between the ground block and PE terminal is lower than 1.5  $\Omega$ ).
3. Try to add a safety capacitor of 0.1  $\mu\text{F}$  to the signal end of the feedback signal terminal of the sensor.
4. Try to add a safety capacitor of 0.1  $\mu\text{F}$  to the power end of the sensor meter (pay attention to the voltage of the power supply and the voltage endurance of the capacitor).
5. For interference on meters connected to the AO terminal of a VFD, if AO uses current signals of 0 to 20 mA, add a capacitor of 0.47  $\mu\text{F}$  between the AO and GND terminals; and if AO uses voltage signals of 0 to 10 V, add a capacitor of 0.1  $\mu\text{F}$  between the AO and GND terminals.

#### Note:

- When a decoupling capacitor is required, add it to the terminal of the device connected to the sensor. For example, if a thermocouple is to transmit signals of 0 to 20 mA to a temperature meter,

the capacitor needs to be added on the terminal of the temperature meter.; if an electronic ruler is to transmit signals of 0 to 30 V to a PLC signal terminal, the capacitor needs to be added on the terminal of the PLC.

- If a large number of meters or sensors are disturbed. It is recommended that you configure an external C2 filter on the input power end of the VFD. For models of filters, see section D.7 Filters.

### 7.7.2 Interference on communication

#### Interference phenomenon

The interference described in this section on 485 communication mainly includes communication delay, out of sync, occasional power-off, or complete power-off that occurs after a VFD is started.

If the communication cannot be implemented properly, regardless of whether the VFD is running, the exception is not necessarily caused by interference. You can find out the causes as follows:

1. Check whether the 485 communication bus is disconnected or in poor contact.
2. Check whether the two ends of line A or B are connected reversely.
3. Check whether the communication protocol (such as the baud rate, data bits, and check bit) of the VFD is consistent with that of the upper computer.

If you are sure that communication exceptions are caused by interference, you can resolve the problem through the following measures:

1. Simple inspection.
2. Arrange the communication cables and motor cables in different cable trays.
3. In multi-VFD application scenarios, adopt the chrysanthemum connection mode to connect the communication cables between VFDs, which can improve the anti-interference capability.
4. In multi-VFD application scenarios, check and ensure that the driving capacity of the master is sufficient.
5. In the connection of multiple VFDs, you need to configure one 120  $\Omega$  terminal resistor on each end.

#### Solution

1. Check and ensure that the ground wire of the motor is connected to the PE terminal of the VFD (if the ground wire of the motor has been connected to the ground block, you need to use a multimeter to measure and ensure that the resistance between the ground block and PE terminal is lower than 1.5  $\Omega$ ).
2. Do not connect the VFD and motor to the same ground terminal as the upper computer. It is recommended that you connect the VFD and motor to the power ground, and connect the upper computer separately to a ground stud.
3. Try to short the signal reference ground terminal (GND) of the VFD with that of the upper computer controller to ensure that ground potential of the communication chip on the control board of the VFD is consistent with that of the communication chip of the upper computer.

4. Try to short GND of the VFD to its ground terminal (PE).
5. Try to add a safety capacitor of 0.1  $\mu\text{F}$  on the power terminal of the upper computer (PLC, HMI, and touch screen). During this process, pay attention to the voltage of the power supply and the voltage endurance capability of the capacitor. Alternatively, you can use a magnet ring (Fe-based nanocrystalline magnet rings are recommended). Put the power L/N line or +/- line of the upper computer through the magnet ring in the same direction and wind 8 coils around the magnet ring.

### 7.7.3 Failure to stop and indicator shimmering due to motor cable coupling

#### Interference phenomenon

1. Failure to stop

In a VFD system where an S terminal is used to control the start and stop, the motor cable and control cable are arranged in the same cable tray. After the system is started properly, the S terminal cannot be used to stop the VFD.

2. Indicator shimmering

After a VFD is started, the relay indicator, power distribution box indicator, PLC indicator, and indication buzzer shimmers, blinks, or emits unusual sounds unexpectedly.

#### Solution

1. Check and ensure that the exception signal cable is arranged 20 cm or farther away from the motor cable.
2. Add a safety capacitor of 0.1  $\mu\text{F}$  between the digital input terminal (S) and the COM terminal.
3. Connect the digital input terminal (S) that controls the start and stop to other idle digital input terminals in parallel. For example, if S1 is used to control the start and stop and S4 is idle, you can try to connect S1 to S4 in parallel.

**Note:** If the controller (such as PLC) in the system controls more than 5 VFDs at the same time through digital input terminals (S), this scheme is not available.

### 7.7.4 Leakage current and interference on RCD

VFDs output high-frequency PWM voltage to drive motors. In this process, the distributed capacitance between the internal IGBT of a VFD and the heat sink and that between the stator and rotor of a motor may inevitably cause the VFD to generate high-frequency leakage current to the ground. A residual current operated protective device (RCD) is used to detect the power-frequency leakage current when a grounding fault occurs on a circuit. The application of a VFD may cause misoperation of a RCD.

1. Rules for selecting RCDs

- (1) VFD systems are special. In these systems, it is required that the rated residual current of common RCDs at all levels is larger than 200 mA, and the VFDs are grounded reliably.
- (2) For RCDs, the time limit of an action needs to be longer than that of a next action, and the time difference between two actions need to be longer than 20 ms. For example, 1s, 0.5s, and 0.2s.
- (3) For circuits in VFD systems, electromagnetic RCDs are recommended. Electromagnetic RCDs

have strong anti-interference capability, and thus can prevent the impact of high-frequency leakage current.

Electronic RCD	Electromagnetic RCD
Low cost, high sensitivity, small in volume, susceptible to voltage fluctuation of the grid and ambient temperature, weak anti-interference capability	Requiring highly sensitive, accurate, and stable zero-phase sequence current transformer, using permalloy high-permeability materials, complex process, high cost, not susceptible to voltage fluctuation of the power supply and ambient temperature, strong anti-interference capability

2. Solution to RCD misoperation (handling the VFD)

- (1) Try to reduce the carrier frequency to 1.5 kHz (P00.14=1.5).
- (2) Try to modify the modulation mode to "3PH modulation and 2PH modulation" (P08.40=00).

3. Solution to RCD misoperation (handling the system power distribution)

- (1) Check and ensure that the power cable is not soaking in water.
- (2) Check and ensure that the cables are not damaged or spliced.
- (3) Check and ensure that no secondary grounding is performed on the neutral wire.
- (4) Check and ensure that the main power cable terminal is in good contact with the air switch or contactor (all screws are tightened).
- (5) Check 1PH powered devices, and ensure that no earth lines are used as neutral wires by these devices.
- (6) Do not use shielded cables as VFD power cables and motor cables.

**7.7.5 Live device chassis**

**Phenomenon**

After a VFD is started, there is sensible voltage on the chassis, and you may feel an electric shock when touching the chassis. The chassis, however, is not live (or the voltage is far lower than the human safety voltage) when the VFD is powered on but not running.

**Solution**

- 1. If there is power distribution grounding or ground stud on the site, ground the cabinet chassis of the drive system through the power ground or stud.
- 2. If there is no grounding on the site, you need to connect the motor chassis to the ground terminal PE of the VFD, and ensure that the jumper at "EMC/J10" on the middle casing of the VFD is shorted.

## 8 Maintenance

### 8.1 What this chapter contains

This chapter describes how to carry out preventive maintenance on UMI-B7 series VFDs.

### 8.2 Periodical inspection

Little maintenance is required when VFDs are installed in environments that meet requirements. The following table describes the recommended routine maintenance.

Subject		Item	Method	Criterion
Ambient environment		Check the temperature, and humidity, and whether there is vibration, dust, gas, oil spray, and water droplets in the environment.	Visual inspection, and use instruments for measurement.	The requirements stated in this manual are met.
		Check whether there are foreign matters, such as tools, or dangerous substances placed nearby.	Visual inspection	There are no tools or dangerous substances placed nearby.
Voltage		Check the voltage of the main circuit and control circuit.	Use multimeters or other instruments for measurement.	The requirements stated in this manual are met.
Keypad		Check the display of information.	Visual inspection	The characters are displayed properly.
		Check whether characters are not completely displayed.	Visual inspection	The requirements stated in this manual are met.
Main circuit	Common	Check whether the bolts loose or come off.	Screw them up.	No exception occurs.
		Check whether the machine is deformed, cracked, or damaged, or their color changes due to overheating and aging.	Visual inspection	No exception occurs.
		Check whether there are stains and dust attached.	Visual inspection	No exception occurs. <b>Note:</b> Discoloration of copper bars does not mean that they cannot work properly.



Subject	Item	Method	Criterion
Conductor and wire	Check whether the conductors are deformed or their color change due to overheat.	Visual inspection	No exception occurs.
	Check whether the wire sheaths are cracked or their color changes.	Visual inspection	No exception occurs.
Terminal block	Check whether there is damage.	Visual inspection	No exception occurs.
Filter capacitor	Check whether there is electrolyte leakage, discoloration, cracks, and chassis expansion.	Visual inspection	No exception occurs.
	Check whether the safety valves are released.	Determine the service life based on the maintenance information, or measure them through electrostatic capacity.	No exception occurs.
	Check whether the electrostatic capacity is measured as required.	Use instruments to measure the capacity.	Electrostatic capacity $\geq$ initial value $\times$ 0.85
Resistor	Check whether there is displacement caused due to overheat.	Olfactory and visual inspection	No exception occurs.
	Check whether the resistors are disconnected.	Visual inspection, or remove one end of the connection cable and use a multimeter for measurement.	Resistance range: $\pm 10\%$ (of the standard resistance)
Transformer and reactor	Check whether there is unusual vibration sounds or smells.	Auditory, olfactory, and visual inspection	No exception occurs.
Electromagnetic contactor and relay	Check whether there are vibration sounds in the workshop.	Auditory inspection	No exception occurs.
	Check whether the contacts	Visual inspection	No exception

Subject		Item	Method	Criterion
		are in good contact.		occurs.
Control circuit	Control PCB, connector	Check whether the screws and connectors loose.	Screw them up.	No exception occurs.
		Check whether there is unusual smell or discoloration.	Olfactory and visual inspection	No exception occurs.
		Check whether there are cracks, damage, deformation, or rust.	Visual inspection	No exception occurs.
		Check whether there is electrolyte leakage or deformation.	Visual inspection, and determine the service life based on the maintenance information.	No exception occurs.
Cooling system	Cooling fan	Check whether there are unusual sounds or vibration.	Auditory and visual inspection, and turn the fan blades with your hand.	The rotation is smooth.
		Check whether the bolts loose.	Screw them up.	No exception occurs.
		Check whether there is discoloration caused due to overheat.	Visual inspection, and determine the service life based on the maintenance information.	No exception occurs.
	Ventilation duct	Check whether there are foreign matters blocking or attached to the cooling fan, air inlets, or air outlets.	Visual inspection	No exception occurs.

### 8.3 Cooling fan

The service life of the cooling fan of the VFD is more than 25,000 hours. The actual service life of the cooling fan is related to the use of the VFD and the temperature in the ambient environment.

You can view the running duration of the VFD through P07.14 (Accumulated running time).

The increase of the bearing noise indicates a fan fault. If the VFD is applied in a key position, replace the fan once the fan starts to generate unusual noise.

	<p>◇ Read chapter 1 Safety precautions carefully and follow the instructions to perform operations. Otherwise, physical injuries or damage to the device may be caused.</p>
---	---

1. Stop the device, disconnect the AC power supply, and wait for a time no shorter than the waiting time designated on the VFD.
2. Open the cable clamp to loosen the fan cable (for VFDs of 460 V, 1.5 to 30 kW, the middle casing needs to be removed).
3. Remove the fan cable.
4. Remove the fan with a screwdriver.
5. Install a new fan in the VFD in the reverse steps. Assemble the VFD. Ensure that the air direction of the fan is consistent with that of the VFD, as shown in the following figure.

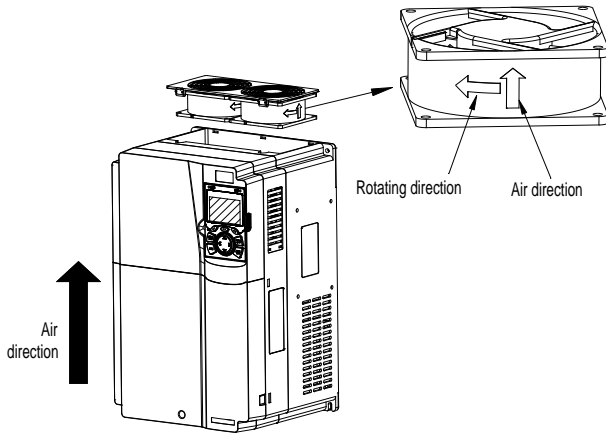

Figure 8-1 Fan maintenance for VFDs of 7.5 kW or higher

6. Power on the VFD.

## 8.4 Capacitor

### 8.4.1 Capacitor reforming

If the VFD has been left unused for a long time, you need to follow the instructions to reform the DC bus capacitor before using it. The storage time is calculated from the date the VFD is delivered.

Storage time	Operation principle
Less than 1 year	No charging operation is required.
1 to 2 years	The VFD needs to be powered on for 1 hour before the first running command.
2 to 3 years	Use a voltage controlled power supply to charge the VFD: Charge the VFD at 25% of the rated voltage for 30 minutes, and then charge it at 50% of the rated voltage for 30 minutes, at 75% for another 30 minutes, and finally charge it at 100% of the rated voltage for 30 minutes.
More than 3 years	Use a voltage controlled power supply to charge the VFD:

Storage time	Operation principle
	Charge the VFD at 25% of the rated voltage for 2 hours, and then charge it at 50% of the rated voltage for 2 hours, at 75% for another 2 hours, and finally charge it at 100% of the rated voltage for 2 hours.

The method for using a voltage controlled power supply to charge the VFD is described as follows:

The selection of a voltage controlled power supply depends on the power supply of the VFD. For VFDs with an incoming voltage of 1PH/3PH 230 V AC, you can use a 230 V AC/2 A voltage regulator. Both 1PH and 3PH VFDs can be charged with a 1PH voltage controlled power supply (connect L+ to R, and N to S or T). All the DC bus capacitors share one rectifier, and therefore they are all charged.

For VFDs of a high voltage class, ensure that the voltage requirement (for example, 460 V) is met during charging. Capacitor charging requires little current, and therefore you can use a small-capacity power supply (2 A is sufficient).

The method for using a resistor (incandescent lamp) to charge the drive is described as follows:

If you directly connect the drive device to a power supply to charge the DC bus capacitor, it needs to be charged for a minimum of 60 minutes. The charging operation must be performed at a normal indoor temperature without load, and you must connect a resistor in series mode in the 3PH circuit of the power supply.

For a 460 V drive device, use a resistor of 1 kΩ/100W. If the voltage of the power supply is no higher than 460 V, you can also use an incandescent lamp of 100W. If an incandescent lamp is used, it may go off or the light may become very weak.

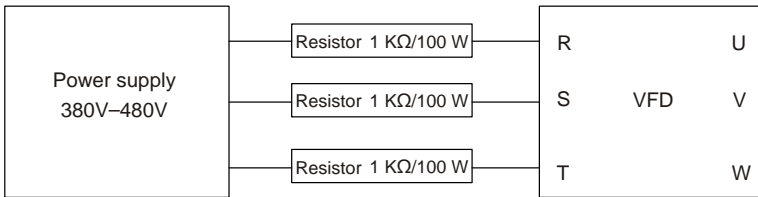

Figure 8-2 Charging circuit example of driving devices of 460 V

**8.4.2 Electrolytic capacitor replacement**

	<p>⚡ Read the safety precautions carefully and follow the instructions to perform operations. Otherwise, physical injuries or damage to the device may be caused.</p>
--	---

The electrolytic capacitor of a VFD must be replaced if it has been used for more than 35,000 hours.

**8.5 Power cable**

	<p>⚡ Read the safety precautions carefully and follow the instructions to perform operations. Otherwise, physical injuries or damage to the device may be caused.</p>
--	---

1. Stop the VFD, disconnect the power supply, and wait for a time no shorter than the waiting time designated on the VFD.

2. Check the connection of the power cables. Ensure that they are firmly connected.
3. Power on the VFD.

## 9 Communication protocol

### 9.1 What this chapter contains

This chapter describes the communication protocol of UMI-B7 series products.

UMI-B7 series VFDs provide RS485 communication interfaces and adopt the master-slave communication based on the international standard Modbus communication protocol. You can implement centralized control (setting commands for controlling the VFD, modifying the running frequency and related function code parameters, and monitoring the working state and fault information of the VFD) through PC/PLC, upper control computer, or other devices to meet specific application requirements.

### 9.2 Modbus protocol introduction

Modbus is a software protocol, a common language used in electronic controllers. By using this protocol, a controller can communicate with other devices through transmission lines. It is a general industrial standard. With this standard, control devices produced by different manufacturers can be connected to form an industrial network and be monitored in a centralized way.

The Modbus protocol provides two transmission modes, namely American Standard Code for Information Interchange (ASCII) and remote terminal units (RTU). On one Modbus network, all the device transmission modes, baud rates, data bits, check bits, stop bits, and other basic parameters must be set consistently.

A Modbus network is a control network with one master and multiple slaves, that is, on one Modbus network, there is only one device serving as the master, and other devices are the slaves. The master can communicate with one slave or broadcast messages to all the slaves. For separate access commands, a slave needs to return a response. For broadcasted information, slaves do not need to return responses.

### 9.3 Application of Modbus

UMI-B7 series VFDs use the RTU mode provided by the Modbus protocol, and RS485 interfaces are used.

#### 9.3.1 RS485

RS485 interfaces work in half-duplex mode and transmit data signals in the differential transmission way, which is also referred to as balanced transmission. An RS485 interface uses a twisted pair, where one wire is defined as A (+), and the other B (-). Generally, if the positive electrical level between the transmission drives A and B ranges from +2 V to +6 V, the logic is "1"; and if it ranges from -2 V to -6 V, the logic is "0".

The 485+ terminal on the terminal block of the VFD corresponds to A, and 485- corresponds to B.

The communication baud rate (P14.01) indicates the number of bits transmitted in a second, and the unit is bit/s (bps). A higher baud rate indicates faster transmission and poorer anti-interference capability. When a twisted pair of 0.56 mm (24 AWG) is used, the maximum transmission distance varies according to the baud rate, as described in the following table.

Baud rate (bps)	Max. transmission distance	Baud rate (bps)	Max. transmission distance
2400	1800 m	9600	800 m
4800	1200 m	19200	600 m

When RS485 interfaces are used for long-distance communication, it is recommended that you use shielded cables, and use the shield layer as the ground wires.

When there are fewer devices and the transmission distance is short, the whole network works well without terminal load resistors. The performance, however, degrades as the distance increases. Therefore, it is recommended that you use a 120 Ω terminal resistor when the transmission distance is long.

**9.3.1.1 Application to one VFD**

Figure 9-1 is the Modbus wiring diagram of one VFD and a PC. Generally, PCs do not provide RS485 interfaces, so you need to convert an RS232 interface or USB port of a PC to an RS485 interface. Connect end A of the RS485 interface to the 485+ port on the terminal block of the VFD, and connect end B to the 485- port. It is recommended that you use shielded twisted pairs. When an RS232-RS485 converter is used, the cable used to connect the RS232 interface of the PC and the converter cannot be longer than 15 m. Use a short cable when possible. It is recommended that you insert the converter directly into the PC. Similarly, when a USB-RS485 converter is used, use a short cable when possible.

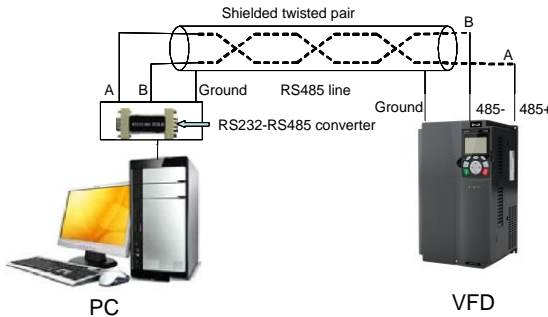

Figure 9-1 Wiring of RS485 applied to one VFD

**9.3.1.2 Application to multiple VFDs**

In practical application to multiple VFDs, chrysanthemum connection and star connection are commonly used.

According to the requirements of the RS485 industrial bus standards, all the devices need to be connected in chrysanthemum mode with one 120 Ω terminal resistor on each end, as shown in Figure 9-2. Figure 9-3 is the simplified wiring diagram, and Figure 9-4 is the practical application diagram.

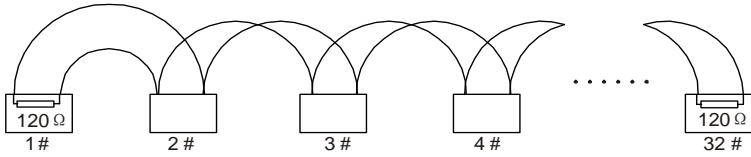

Figure 9-2 On-site chrysanthemum connection diagram

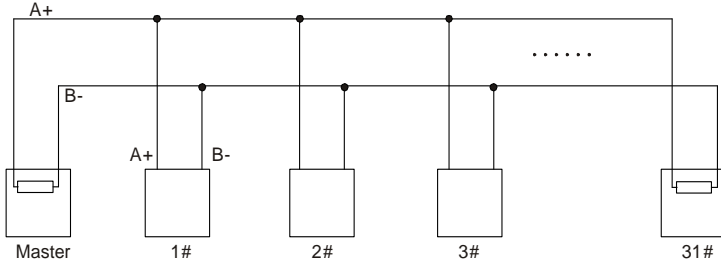

Figure 9-3 Simplified chrysanthemum connection diagram

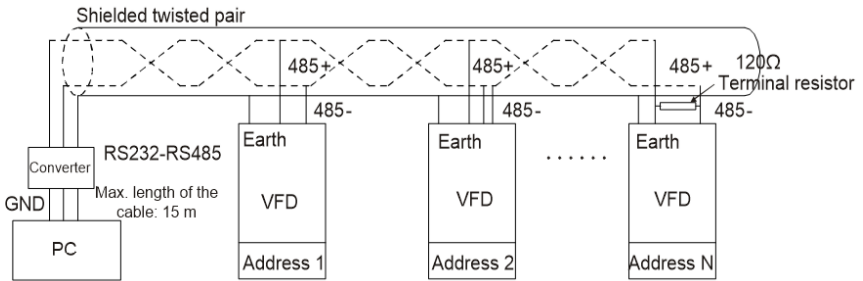

Figure 9-4 Practical application diagram of chrysanthemum connection

Figure 9-5 shows the star connection diagram. When this connection mode is adopted, the two devices that are farthest away from each other on the line must be connected with a terminal resistor (in Figure 9-5, the two devices are devices 1# and 15#).

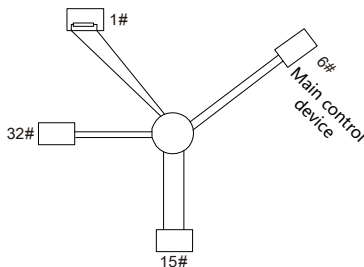

Figure 9-5 Star connection

Use shielded cable, if possible, in multi-device connection. The baud rates, data bit check settings,



and other basic parameters of all the devices on the RS485 line must be set consistently, and addresses cannot be repeated.

**9.3.2 RTU mode**

**9.3.2.1 RTU communication frame structure**

When a controller is set to use the RTU communication mode on a Modbus network, every byte (8 bits) in the message includes 2 hexadecimal characters (each includes 4 bits). Compared with the ASCII mode, the RTU mode can transmit more data with the same baud rate.

**Code system**

- 1 start bit
- 7 or 8 data bits; the minimum valid bit is transmitted first. Each frame domain of 8 bits includes 2 hexadecimal characters (0–9, A–F).
- 1 odd/even check bit; this bit is not provided if no check is needed.
- 1 stop bit (with check performed), 2 bits (without check)

**Error detection domain**

- Cyclic redundancy check (CRC)

The following table describes the data format.

11-bit character frame (Bits 0 to 7 are data bits)

Start bit	BIT0	BIT1	BIT2	BIT3	BIT4	BIT5	BIT6	BIT7	Check bit	Stop bit
-----------	------	------	------	------	------	------	------	------	-----------	----------

10-bit character frame (Bits 0 to 6 are data bits)

Start bit	BIT0	BIT1	BIT2	BIT3	BIT4	BIT5	BIT6	Check bit	Stop bit
-----------	------	------	------	------	------	------	------	-----------	----------

In a character frame, only the data bits carry information. The start bit, check bit, and stop bit are used to facilitate the transmission of the data bits to the destination device. In practical applications, you must set the data bits, parity check bits, and stop bits consistently.

In RTU mode, the transmission of a new frame always starts from an idle time (the transmission time of 3.5 bytes). On a network where the transmission rate is calculated based on the baud rate, the transmission time of 3.5 bytes can be easily obtained. After the idle time ends, the data domains are transmitted in the following sequence: slave address, operation command code, data, and CRC check character. Each byte transmitted in each domain includes 2 hexadecimal characters (0–9, A–F). The network devices always monitor the communication bus. After receiving the first domain (address information), each network device identifies the byte. After the last byte is transmitted, a similar transmission interval (the transmission time of 3.5 bytes) is used to indicate that the transmission of the frame ends. Then, the transmission of a new frame starts.

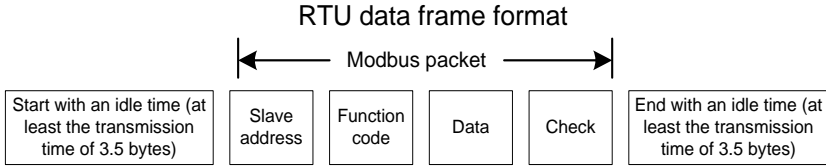

The information of a frame must be transmitted in a continuous data flow. If there is an interval greater than the transmission time of 1.5 bytes before the transmission of the entire frame is complete, the receiving device deletes the incomplete information, and mistakes the subsequent byte for the address domain of a new frame. Similarly, if the transmission interval between two frames is shorter than the transmission time of 3.5 bytes, the receiving device mistakes it for the data of the last frame. The CRC check value is incorrect due to the disorder of the frames, and thus a communication fault occurs.

The following table describes the standard structure of an RTU frame.

START (frame header)	T1-T2-T3-T4 (transmission time of 3.5 bytes)
ADDR (slave address domain)	Communication address: 0–247 (decimal system) (0 is the broadcast address)
CMD (function domain)	03H: read slave parameters 06H: write slave parameters
DATA (N-1) ... DATA (0) (data domain)	Data of 2×N bytes, main content of the communication as well as the core of data exchanging
CRC CHK LSB	Detection value: CRC (16 bits)
CRC CHK MSB	
END (frame tail)	T1-T2-T3-T4 (transmission time of 3.5 bytes)

**9.3.2.2 RTU communication frame error check modes**

During the transmission of data, errors may occur due to various factors. Without check, the data receiving device cannot identify data errors and may make a wrong response. The wrong response may cause severe problems. Therefore, the data must be checked.

The check is implemented as follows: The transmitter calculates the to-be-transmitted data based on a specific algorithm to obtain a result, adds the result to the rear of the message, and transmits them together. After receiving the message, the receiver calculates the data based on the same algorithm to obtain a result, and compares the result with that transmitted by the transmitter. If the results are the same, the message is correct. Otherwise, the message is considered wrong.

The error check of a frame includes two parts, namely, bit check on individual bytes (that is, odd/even check using the check bit in the character frame), and whole data check (CRC check).

**Bit check on individual bytes (odd/even check)**

You can select the bit check mode as required, or you can choose not to perform the check, which will affect the check bit setting of each byte.

Definition of even check: Before the data is transmitted, an even check bit is added to indicate whether the number of "1" in the to-be-transmitted data is odd or even. If it is even, the check bit is set to "0"; and if it is odd, the check bit is set to "1".

Definition of odd check: Before the data is transmitted, an odd check bit is added to indicate whether the number of "1" in the to-be-transmitted data is odd or even. If it is odd, the check bit is set to "0"; and if it is even, the check bit is set to "1".

For example, the data bits to be transmitted are "11001110", including five "1". If the even check is applied, the even check bit is set to "1"; and if the odd check is applied, the odd check bit is set to "0". During the transmission of the data, the odd/even check bit is calculated and placed in the check bit of the frame. The receiving device performs the odd/even check after receiving the data. If it finds that the odd/even parity of the data is inconsistent with the preset information, it determines that a communication error occurs.

### **CRC check mode**

A frame in the RTU format includes an error detection domain based on the CRC calculation. The CRC domain checks all the content of the frame. The CRC domain consists of two bytes, including 16 binary bits. It is calculated by the transmitter and added to the frame. The receiver calculates the CRC of the received frame, and compares the result with the value in the received CRC domain. If the two CRC values are not equal to each other, errors occur in the transmission.

During CRC, 0xFFFF is stored first, and then a process is invoked to process a minimum of 6 contiguous bytes in the frame based on the content in the current register. CRC is valid only for the 8-bit data in each character. It is invalid for the start, end, and check bits.

During the generation of the CRC values, the "exclusive or" (XOR) operation is performed on the each 8-bit character and the content in the register. The result is placed in the bits from the least significant bit (LSB) to the most significant bit (MSB), and 0 is placed in the MSB. Then, LSB is detected. If LSB is 1, the XOR operation is performed on the current value in the register and the preset value. If LSB is 0, no operation is performed. This process is repeated 8 times. After the last bit (8<sup>th</sup> bit) is detected and processed, the XOR operation is performed on the next 8-bit byte and the current content in the register. The final values in the register are the CRC values obtained after operations are performed on all the bytes in the frame.

The calculation adopts the international standard CRC check rule. You can refer to the related standard CRC algorithm to compile the CRC calculation program as required.

The following is a simple CRC calculation function for your reference (using the C programming language):

```
unsigned int    crc_cal_value(unsigned char*data_value,unsigned char
data_length)
{
    int i;
    unsigned int crc_value=0xffff;
```

```

while (data_length--)
{
    crc_value^=xdata_value++;
    for (i=0;i<8;i++)
    {
        if (crc_value&0x0001)
            crc_value=(crc_value>>1)^0xa001;
        else
            crc_value=crc_value>>1;
    }
}
return (crc_value);
}

```

In the ladder logic, CKSM uses the table look-up method to calculate the CRC value according to the content in the frame. The program of this method is simple, and the calculation is fast, but the ROM space occupied is large. Use this program with caution in scenarios where there are space occupation limits on programs.

**9.4 RTU command code and communication data**

**9.4.1 Command code: 03H, reading N words (continuously reading a maximum of 16 words)**

The command code 03H is used by the master to read data from the VFD. The quantity of data to be read depends on the "data quantity" in the command. A maximum of 16 pieces of data can be read. The addresses of the read parameters must be contiguous. Each piece of data occupies 2 bytes, that is, one word. The command format is presented using the hexadecimal system (a number followed by "H" indicates a hexadecimal value). One hexadecimal value occupies one byte.

The 03H command is used to read information including the parameters and operation state of the VFD.

For example, starting from the data address of 0004H, to read two contiguous pieces of data (that is, to read content from the data addresses 0004H and 0005H), the structure of the frame is described in the following table.

RTU master command (transmitted by the master to the VFD)

START	T1-T2-T3-T4 (transmission time of 3.5 bytes)
ADDR (address)	01H
CMD (command code)	03H
Most significant byte (MSB) of the start address	00H

Least significant byte (LSB) of the start address	04H
MSB of data quantity	00H
LSB of data quantity	02H
LSB of CRC	85H
MSB of CRC	CAH
END	T1-T2-T3-T4 (transmission time of 3.5 bytes)

The value in START and END is "T1-T2-T3-T4 (transmission time of 3.5 bytes)", indicating that the RS485 needs to stay idle for at least the transmission time of 3.5 bytes. An idle time is required to distinguish on message from another to ensure that the two messages are not regarded as one.

The value of ADDR is 01H, indicating that the command is transmitted to the VFD whose address is 01H. The ADDR information occupies one byte.

The value of CMD is 03H, indicating that the command is used to read data from the VFD. The CMD information occupies one byte.

"Start address" indicates that data reading is started from this address. It occupies two bytes, with the MSB on the left and LSB on the right.

"Data quantity" indicates the quantity of data to be read (unit: word).

The value of "Start address" is 0004H, and that of "Data quantity" is 0002H, indicating that data is to be read from the data addresses of 0004H and 0005H.

CRC check occupies two bytes, with the LSB on the left, and MSB on the right.

RTU slave response (transmitted by the VFD to the master)

START	T1-T2-T3-T4 (transmission time of 3.5 bytes)
ADDR	01H
CMD	03H
Number of bytes	04H
MSB of data in 0004H	13H
LSB of data in 0004H	88H
MSB of data in 0005H	00H
LSB of data in 0005H	00H
LSB of CRC	7EH
MSB of CRC	9DH
END	T1-T2-T3-T4 (transmission time of 3.5 bytes)

The definition of the response information is described as follows:

The value of ADDR is 01H, indicating that the message is transmitted by the VFD whose address is 01H. The ADDR information occupies one byte.

The value of CMD is 03H, indicating that the message is a response of the VFD to the 03H command

of the master for reading data. The CMD information occupies one byte.

"Number of bytes" indicates the number of bytes between a byte (not included) and the CRC byte (not included). The value 04 indicates that there are four bytes of data between "Number of bytes" and "LSB of CRC", that is, "MSB of data in 0004H", "LSB of data in 0004H", "MSB of data in 0005H", and "LSB of data in 0005H".

A piece of data is two bytes, with the MSB on the left and LSB on the right. From the response, we can see that the data in 0004H is 1388H, and that in 0005H is 0000H.

CRC check occupies two bytes, with the LSB on the left, and MSB on the right.

**9.4.2 Command code: 06H, writing a word**

This command is used by the master to write data to the VFD. One command can be used to write only one piece of data. It is used to modify the parameters and operation mode of the VFD.

For example, to write 5000 (1388H) to 0004H of the VFD whose address is 02H, the structure of the frame is described in the following table.

RTU master command (transmitted by the master to the VFD)

START	T1-T2-T3-T4 (transmission time of 3.5 bytes)
ADDR	02H
CMD	06H
MSB of data writing address	00H
LSB of data writing address	04H
MSB of to-be-written data	13H
LSB of to-be-written data	88H
LSB of CRC	C5H
MSB of CRC	6EH
END	T1-T2-T3-T4 (transmission time of 3.5 bytes)

RTU slave response (transmitted by the VFD to the master)

START	T1-T2-T3-T4 (transmission time of 3.5 bytes)
ADDR	02H
CMD	06H
MSB of data writing address	00H
LSB of data writing address	04H
MSB of to-be-written data	13H
LSB of to-be-written data	88H
LSB of CRC	C5H
MSB of CRC	6EH
END	T1-T2-T3-T4 (transmission time of 3.5 bytes)

**Note:** Sections 9.4.1 and 9.4.2 mainly describe the command formats. For the detailed application, see the examples in section 9.4.7.

### 9.4.3 Command code: 10H, continuous writing

The command code 10H is used by the master to write data to the VFD. The quantity of data to be written is determined by "Data quantity", and a maximum of 16 pieces of data can be written.

For example, to write 5000 (1388H) and 50 (0032H) respectively to 0004H and 0005H of the VFD whose slave address is 02H, the structure of the frame is described in the following table.

RTU master command (transmitted by the master to the VFD)

START	T1-T2-T3-T4 (transmission time of 3.5 bytes)
ADDR	02H
CMD	10H
MSB of data writing address	00H
LSB of data writing address	04H
MSB of data quantity	00H
LSB of data quantity	02H
Number of bytes	04H
MSB of data to be written to 0004H	13H
LSB of data to be written to 0004H	88H
MSB of data to be written to 0005H	00H
LSB of data to be written to 0005H	32H
LSB of CRC	C5H
MSB of CRC	6EH
END	T1-T2-T3-T4 (transmission time of 3.5 bytes)

RTU slave response (transmitted by the VFD to the master)

START	T1-T2-T3-T4 (transmission time of 3.5 bytes)
ADDR	02H
CMD	10H
MSB of data writing address	00H
LSB of data writing address	04H
MSB of data quantity	00H
LSB of data quantity	02H
LSB of CRC	C5H
MSB of CRC	6EH
END	T1-T2-T3-T4 (transmission time of 3.5 bytes)

### 9.4.4 Data address definition

This section describes the address definition of communication data. The addresses are used for controlling the running, obtaining the state information, and setting related function parameters of the VFD.

#### 9.4.4.1 Function code address representation rules

The address of a function code consists of two bytes, with the MSB on the left and LSB on the right.

The MSB ranges from 00 to ffH, and the LSB also ranges from 00 to ffH. The MSB is the hexadecimal form of the group number before the dot mark, and LSB is that of the number behind the dot mark. Take P05.06 as an example, the group number is 05, that is, the MSB of the parameter address is the hexadecimal form of 05; and the number behind the dot mark is 06, that is, the LSB is the hexadecimal form of 06. Therefore, the function code address is 0506H in the hexadecimal form. For P10.01, the parameter address is 0A01H.

Function code	Name	Detailed parameter description	Setting range	Default value	Modify
P10.00	Simple PLC mode	0: Stop after running once 1: Keep running in the final value after running once 2: Cyclic running	0-2	0	<input type="radio"/>
P10.01	Simple PLC memory selection	0: No memory after power down 1: Memory after power down	0-1	0	<input type="radio"/>

**Note:**

1. The parameters in the P99 group are set by the manufacturer. They cannot be read or modified. Some parameters cannot be modified when the VFD is running; some cannot be modified regardless of the state of the VFD. Pay attention to the setting range, unit, and related description of a parameter when modifying it.
2. The service life of the Electrically Erasable Programmable Read-Only Memory (EEPROM) may be reduced if it is frequently used for storage. Some function codes do not need to be stored during communication. The application requirements can be met by modifying the value of the on-chip RAM, that is, modifying the MSB of the corresponding function code address from 0 to 1. For example, if P00.07 is not to be stored in the EEPROM, you need only to modify the value of the RAM, that is, set the address to 8007H. The address can be used only for writing data to the on-chip RAM, and it is invalid when used for reading data.

**9.4.4.2 Description of other function code addresses**

In addition to modifying the parameters of the VFD, the master can also control the VFD, such as start and stop it, and monitor the operation state of the VFD. The following table describes other function parameters.

Function	Address	Data description	R/W
Communication-based control command	2000H	0001H: Forward running	R/W
		0002H: Reverse running	
		0003H: Forward jogging	
		0004H: Reverse jogging	
		0005H: Stop	
		0006H: Coast to stop	
		0007H: Fault reset	



Function	Address	Data description	R/W
		0008H: Jogging to stop	
Communication-based value setting	2001H	Communication-based frequency setting (0–Fmax, unit: 0.01 Hz)	R/W
	2002H	PID setting, range (0–1000, 1000 corresponding to 100.0%)	
	2003H	PID feedback, range (0–1000, 1000 corresponding to 100.0%)	R/W
	2004H	Torque setting (-3000–+3000, 1000 corresponding to 100.0% of the rated current of the motor)	R/W
	2005H	Setting of the upper limit of the forward running frequency (0–Fmax, unit: 0.01 Hz)	R/W
	2006H	Setting of the upper limit of the reverse running frequency (0–Fmax, unit: 0.01 Hz)	R/W
	2007H	Upper limit of the electromotive torque (0–3000, 1000 corresponding to 100.0% of the rated current of the VFD)	R/W
	2008H	Upper limit of the braking torque (0–3000, 1000 corresponding to 100.0% of the rated current of the motor)	R/W
	2009H	Special control command word: Bit1–0 =00: Motor 1 =01: Motor 2 =10: Motor 3 =11: Motor 4 Bit2: =1 Torque control disabled =0: Torque control cannot be disabled Bit3: =1 Power consumption reset to 0 =0: Power consumption not reset Bit4: =1 Pre-excitation =0: Pre-excitation disabled Bit5: =1 DC braking =0: DC braking disabled	R/W
	200AH	Virtual input terminal command, range: 0x000–0x3FF Corresponding to S8/S7/S6/S5/HDIB/HDIA/S4/S3/S2/S1	R/W
200BH	Virtual output terminal command, range: 0x00–0x0F Corresponding to the local RO2/RO1/HDO/Y1	R/W	
200CH	Voltage setting (used when V/F separation is implemented) (0–1000, 1000 corresponding to 100.0% of the rated voltage of the motor)	R/W	
200DH	AO output setting 1 (-1000–+1000, 1000 corresponding to 100.0%)	R/W	

Function	Address	Data description	R/W
	200EH	AO output setting 2 (-1000--+1000, 1000 corresponding to 100.0%)	R/W
VFD status word 1	2100H	0001H: Forward running	R
		0002H: Reverse running	
		0003H: Stopped	
		0004H: Faulty	
		0005H: POFF	
		0006H: Pre-excited	
VFD status word 2	2101H	Bit0: =0: Not ready to run =1: Ready to run Bit2-1: =00: Motor 1 =01: Motor 2 =10: Motor 3 =11: Motor 4 Bit3: =0: Asynchronous machine =1: Synchronous machine Bit4: =0: No overload alarm =1: Overload alarm Bit6-5: =00: Keypad-based control =01: Terminal-based control =10: Communication-based control Bit7: Reserved Bit8: =0: Speed control =1: Torque control Bit9: =0: Non-position control =1: Position control Bit11-10: =0: Vector 0 =1: Vector 1 =2: Closed-loop vector =3: Space voltage vector	R
VFD fault code	2102H	See the description of fault types.	R
Running frequency	3000H	0-Fmax (unit: 0.01Hz)	R
Set frequency	3001H	0-Fmax (unit: 0.01Hz)	R
Bus voltage	3002H	0.0-2000.0 V (unit: 0.1V)	R
Output voltage	3003H	0-1200V (unit: 1V)	R
Output current	3004H	0.0-3000.0A (unit: 0.1A)	R
Rotating speed	3005H	0-65535 (unit: 1 rpm)	R
Output power	3006H	-300.0--+300.0% (unit: 0.1%)	R
Output torque	3007H	-250.0--+250.0% (unit: 0.1%)	R
Closed-loop setting	3008H	-100.0--+100.0% (unit: 0.1%)	R
Closed-loop feedback	3009H	-100.0--+100.0% (unit: 0.1%)	R
Input state	300AH	0x00-0x3F Corresponding to the local HD1B/HDIA/S4/S3/S2/S1	R

Function	Address	Data description	R/W
Output state	300BH	0x00–0x0F Corresponding to the local RO2/RO1/HDO/Y1	R
Analog input 1	300CH	0.00–10.00V (unit: 0.01V)	R
Analog input 2	300DH	0.00–10.00V (unit: 0.01V)	R
Analog input 3	300EH	-10.00–10.00V (unit: 0.01V)	R
Analog input 4	300FH		R
Read input of high-speed pulse 1	3010H	0.00–50.00kHz (unit: 0.01Hz)	R
Read input of high-speed pulse 2	3011H		R
Read current step of multi-step speed	3012H	0–15	R
External length	3013H	0–65535	R
External count value	3014H	0–65535	R
Torque setting	3015H	-300.0→+300.0% (unit: 0.1%)	R
Identification code	3016H		R
Fault code	5000H		R

The Read/Write (R/W) characteristics indicate whether a function can be read and written. For example, "Communication-based control command" can be written, and therefore the command code 6H is used to control the VFD. The R characteristic indicates that a function can only be read, and W indicates that a function can only be written.

**Note:** Some parameters in the preceding table are valid only after they are enabled. Take the running and stop operations as examples, you need to set "Running command channel" (P00.01) to "Communication", and set "Communication running command channel" (P00.02) to the Modbus communication channel. For another example, when modifying "PID setting", you need to set "PID reference source" (P09.00) to Modbus communication.

**9.4.5 Fieldbus scale**

In practical applications, communication data is represented in the hexadecimal form, but hexadecimal values cannot represent decimals. For example, 50.12 Hz cannot be represented in the hexadecimal form. In such cases, we can multiply 50.12 by 100 to obtain an integer 5012, and then 50.12 can be represented as 1394H (5012 in the decimal form) in the hexadecimal form.

In the process of multiplying a non-integer by a multiple to obtain an integer, the multiple is referred to

as a fieldbus scale.

The fieldbus scale depends on the number of decimals in the value specified in "Detailed parameter description" or "Default value". If there are  $n$  decimals in the value, the fieldbus scale  $m$  is the  $n^{\text{th}}$ -power of 10. Take the following table as an example,  $m$  is 10.

Function code	Name	Detailed parameter description	Default value
P01.20	Wake-up-from-sleep delay	0.0–3600.0s (valid when the ones place of P01.19 is 2)	0.0s
P01.21	Restart after power down	0: Restart is disabled 1: Restart is enabled	0

The value specified in "Detailed parameter description" or "Default value" contains one decimal, so the fieldbus scale is 10. If the value received by the upper computer is 50, the value of "Wake-up-from-sleep delay" of the VFD is 5.0 (5.0=50/10).

To set the "Wake-up-from-sleep delay" to 5.0s through Modbus communication, you need first to multiply 5.0 by 10 according to the scale to obtain an integer 50, that is, 32H in the hexadecimal form, and then transmit the following write command:

01      06      01 14      00 32      49 E7  
 VFD      Write      Parameter      Parameter      CRC  
 address      command      address      data

After receiving the command, the VFD converts 50 into 5.0 based on the fieldbus scale, and then sets "Wake-up-from-sleep delay" to 5.0s.

For another example, after the upper computer transmits the "Wake-up-from-sleep delay" parameter read command, the master receives the following response from the VFD:

01      03      02      00 32      39 91  
 VFD      Read      2-byte      Parameter      CRC  
 address      command      data      data

The parameter data is 0032H, that is, 50, so 5.0 is obtained based on the fieldbus scale (50/10=5.0). In this case, the master identifies that the "Wake-up-from-sleep delay" is 5.0s.

**9.4.6 Error message response**

Operation errors may occur in communication-based control. For example, some parameters can only be read, but a write command is transmitted. In this case, the VFD returns an error message response.

Error message responses are transmitted by the VFD to the master. The following table describes the codes and definitions of the error message responses.

Code	Name	Definition
01H	Invalid	The command code received by the upper computer is not allowed

Code	Name	Definition
	command	to be executed. The possible causes are as follows: <ul style="list-style-type: none"> <li>• The function code is applicable only on new devices and is not implemented on this device.</li> <li>• The slave is in the faulty state when processing this request.</li> </ul>
02H	Invalid data address	For the VFD, the data address in the request of the upper computer is not allowed. In particular, the combination of the register address and the number of the to-be-transmitted bytes is invalid.
03H	Invalid data bit	The received data domain contains a value that is not allowed. The value indicates the error of the remaining structure in the combined request. <p><b>Note:</b> It does not mean that the data item submitted for storage in the register includes a value unexpected by the program.</p>
04H	Operation failure	The parameter is set to an invalid value in the write operation. For example, a function input terminal cannot be set repeatedly.
05H	Password error	The password entered in the password verification address is different from that set in P07.00.
06H	Data frame error	The length of the data frame transmitted by the upper computer is incorrect, or in the RTU format, the value of the CRC check bit is inconsistent with the CRC value calculated by the lower computer
07H	Parameter read-only	The parameter to be modified in the write operation of the upper computer is a read-only parameter.
08H	Parameter cannot be modified in running	The parameter to be modified in the write operation of the upper computer cannot be modified during the running of the VFD.
09H	Password protection	A user password is set, and the upper computer does not provide the password to unlock the system when performing a read or write operation. The error of "system locked" is reported.

When returning a response, the device uses a function code domain and fault address to indicate whether it is a normal response (no error) or exception response (some errors occur). In a normal response, the device returns the corresponding function code and data address or sub-function code. In an exception response, the device returns a code that is equal to a normal code, but the first bit is logic 1.

For example, if the master device transmits a request message to a slave device for reading a group of function code address data, the code is generated as follows:

0 0 0 0 0 1 1 (03H in the hexadecimal form)

For a normal response, the same code is returned.

For an exception response, the following code is returned:

1 0 0 0 0 1 1 (83H in the hexadecimal form)

In addition to the modification of the code, the slave returns a byte of exception code that describes the cause of the exception. After receiving the exception response, the typical processing of the master device is to transmit the request message again or modify the command based on the fault information.

For example, to set the "Running command channel" (P00.01, the parameter address is 0001H) of the VFD whose address is 01H to 03, the command is as follows:

<b><u>01</u></b>	<b><u>06</u></b>	<b><u>00 01</u></b>	<b><u>00 03</u></b>	<b><u>98 0B</u></b>
VFD address	Write command	Parameter address	Parameter data	CRC

But the setting range of the "Running command channel" is 0 to 2. The value 3 exceeds the setting range. In this case, the VFD returns an error message response as shown in the following:

<b><u>01</u></b>	<b><u>86</u></b>	<b><u>04</u></b>	<b><u>43 A3</u></b>
VFD address	Exception response code	Error code	CRC

The exception response code 86H (generated based on the MSB "1" of the write command 06H) indicates that it is an exception response to the write command (06H). The error code is 04H. From the preceding table, we can see that it indicates the error "Operation failure", which means "The parameter is set to an invalid value in the write operation".

**9.4.7 Read/Write operation example**

For the formats of the read and write commands, see sections 9.4.1 and 9.4.2.

**9.4.7.1 Read command 03H examples**

Example 1: Read status word 1 of the VFD whose address is 01H. From the table of other function parameters, the parameter address of status word 1 of the VFD is 2100H.

The read command transmitted to the VFD is as follows:

<b><u>01</u></b>	<b><u>03</u></b>	<b><u>21 00</u></b>	<b><u>00 01</u></b>	<b><u>8E 36</u></b>
VFD address	Read command	Parameter address	Data quantity	CRC

Assume that the following response is returned:

<b><u>01</u></b>	<b><u>03</u></b>	<b><u>02</u></b>	<b><u>00 03</u></b>	<b><u>F8 45</u></b>
VFD address	Read command	Number of bytes	Data content	CRC

The data content returned by the VFD is 0003H, which indicates that the VFD is in the stopped state.

Example 2: View information about the VFD whose address is 03H, including "Type of present fault"

(P07.27) to "Type of the 5th-last fault" (P07.32) of which the parameter addresses are 071BH to 0720H (contiguous 6 parameter addresses starting from 071BH).

The command transmitted to the VFD is as follows:

**03**      **03**      **07 1B**      **00 06**      **B5 59**  
 VFD      Read      Start      6 parameters in total      CRC  
 address      command      address

Assume that the following response is returned:

**03** **03** **0C** **00 23** **00 23** **00 23** **00 23** **00 23** **00 23** **00 23** **5F D2**  
 VFD    Read    Number of    Type of    Type of    Type of last    Type of last    Type of last    Type of last    Type of last    CRC  
 address    command    bytes    current fault    last fault    but one fault    but two fault    but three fault    but four fault

From the returned data, all the fault types are 0023H, that is, 35 in the decimal form, which means the maladjustment fault (STo).

**9.4.7.2 Write command 06H examples**

Example 1: Set the VFD whose address is 03H to be forward running. According to the table in 9.4.4.2 Description of other function code addresses, the address of "Communication-based control command" is 2000H, and 0001H indicates forward running, as shown in the following figure.

Function	Address	Data description	R/W
Communication-based control command	2000H	0001H: Forward running	R/W
		0002H: Reverse running	
		0003H: Forward jogging	
		0004H: Reverse jogging	
		0005H: Stop	
		0006H: Coast to stop	
		0007H: Fault reset	
		0008H: Jogging to stop	

The command transmitted by the master is as follows:

**03**      **06**      **20 00**      **00 01**      **42 28**  
 VFD      Write      Parameter      Forward      CRC  
 address      command      address      running

If the operation is successful, the following response is returned (same as the command transmitted by the master):

**03**      **06**      **20 00**      **00 01**      **42 28**  
 VFD      Write      Parameter      Forward      CRC  
 address      command      address      running

Example 2: Set the "Max. output frequency" of the VFD whose address is 03H to 100 Hz.

Function code	Name	Detailed parameter description	Default value	Modify
P00.03	Max. output frequency	Used to set the maximum output frequency of the VFD. It is the basis of frequency setting and the acceleration/deceleration. Setting range: Max(P00.04, 10.00) – 630.00Hz	60.00Hz	⊙

From the number of decimals, the fieldbus scale of the "Max. output frequency" (P00.03) is 100. Multiply 100 Hz by 100. The value 10000 is obtained, and it is 2710H in the hexadecimal form.

The command transmitted by the master is as follows:

**03**      **06**      **00 03**      **27 10**      **62 14**  
 VFD      Write      Parameter      Parameter      CRC  
 address      command      address      data

If the operation is successful, the following response is returned (same as the command transmitted by the master):

**03**      **06**      **00 03**      **27 10**      **62 14**  
 VFD      Write      Parameter      Parameter      CRC  
 address      command      address      data

**Note:** In the preceding command description, spaces are added to a command just for explanatory purposes. In practical applications, no space is required in the commands.

**9.4.7.3 Continuously write command 10H examples**

Example 1: Set the VFD whose address is 01H to be forward running at the frequency of 10 Hz. Refer to the table of other function parameters, the address of "Communication-based control command" is 2000H, 0001H indicates forward running, and the address of "Communication-based value setting" is 2001H, as shown in the following figure. 10 Hz is 03E8H in the hexadecimal form.

Function	Address	Data description	R/W
Communication-based control command	2000H	0001H: Forward running	R/W
		0002H: Reverse running	
		0003H: Forward jogging	
		0004H: Reverse jogging	
		0005H: Stop	
		0006H: Coast to stop	
		0007H: Fault reset	
		0008H: Jogging to stop	
Communication-based value setting	2001H	Communication-based frequency setting (0–Fmax, unit: 0.01 Hz)	R/W
	2002H	PID setting, range (0–1000, 1000 corresponding to 100.0%)	



In the actual operation, set P00.01 to 2 and P00.06 to 8.

The command transmitted by the master is as follows:

**01**   **10**   **20 00**   **00 02**   **04**   **00 01**   **03 E8**   **3B 10**  
 VFD   Continuous   Parameter   Parameter   Number of   Forward   10 Hz   CRC  
 address   write   address   quantity   bytes   running

Continuous write command

If the operation is successful, the following response is returned:

**01**   **10**   **20 00**   **00 02**   **4A 08**  
 VFD   Continuous   Parameter   Parameter   CRC  
 address   write   address   quantity

Continuous write command

Example 2: Set "Acceleration time" of the VFD whose address is 01H to 10s, and "Deceleration time" to 20s.

Function code	Name	Detailed parameter description	Default value	Modify
P00.11	Acceleration time 1	Acceleration time is the time needed for accelerating from 0Hz to Max. output frequency (P00.03). Deceleration time is the time needed from decelerating from Max. output frequency (P00.03) to 0Hz.	Depends on model	<input type="radio"/>
P00.12	Deceleration time 1	UMI-B7 series VFD defines four groups of acceleration and deceleration time, which can be selected via multifunction digital input terminals (P05 group). The acceleration/deceleration time of the VFD is the first group by default. Setting range of P00.11 and P00.12: 0.0–3600.0s	Depends on model	<input type="radio"/>

The address of P00.11 is 000B, 10s is 0064H in the hexadecimal form, and 20s is 00C8H in the hexadecimal form.

The command transmitted by the master is as follows:

**01**   **10**   **00 0B**   **00 02**   **04**   **00 64**   **00 C8**   **F2 55**  
 VFD   Continuous   Parameter   Parameter   Number of   10s   20s   CRC  
 address   write   address   quantity   bytes

Continuous write command

If the operation is successful, the following response is returned:

**01**   **10**   **00 0B**   **00 02**   **30 0A**  
 VFD   Continuous   Parameter   Parameter   CRC  
 address   write   address   quantity

Continuous write command

**Note:** In the preceding command description, spaces are added to a command just for explanatory purposes. In practical applications, no space is required in the commands.

**9.4.7.4 Modbus communication commissioning example**

A PC is used as the host, an RS232-RS485 converter is used for signal conversion, and the PC serial port used by the converter is COM1 (an RS232 port). The upper computer commissioning software is the serial port commissioning assistant Commix, which can be downloaded from the Internet. Download a version that can automatically execute the CRC check function. The following figure shows the interface of Commix.



First, set the serial port to **COM1**. Then, set the baud rate consistently with P14.01. The data bits, check bits, and stop bits must be set consistently with P14.02. If the RTU mode is selected, you need to select the hexadecimal form **Input HEX**. To set the software to automatically execute the CRC function, you need to select **ModbusRTU**, select **CRC16 (MODBU SRTU)**, and set the start byte to **1**. After the auto CRC check function is enabled, do not enter CRC information in commands. Otherwise, command errors may occur due to repeated CRC check.

The commissioning command to set the VFD whose address is 03H to be forward running is as follows:

<b><u>03</u></b>	<b><u>06</u></b>	<b><u>20 00</u></b>	<b><u>00 01</u></b>	<b><u>42 28</u></b>
VFD address	Write command	Parameter address	Forward running	CRC

**Note:**

1. Set the address (P14.00) of the VFD to 03.
2. Set "Channel of running commands" (P00.01) to "Communication", and set "Communication channel of running commands" (P00.02) to the Modbus communication channel.
3. Click **Send**. If the line configuration and settings are correct, a response transmitted by the VFD is received as follows:

<b><u>03</u></b>	<b><u>06</u></b>	<b><u>20 00</u></b>	<b><u>00 01</u></b>	<b><u>42 28</u></b>
VFD address	Write command	Parameter address	Forward running	CRC

## 9.5 Common communication faults

Common communication faults include the following:

- No response is returned.
- The VFD returns an exception response.

Possible causes of no response include the following:

- The serial port is set incorrectly. For example, the converter uses the serial port COM1, but COM2 is selected for the communication.
- The settings of the baud rates, data bits, stop bits, and check bits are inconsistent with those set on the VFD.
- The positive pole (+) and negative pole (-) of the RS485 bus are connected reversely.
- The resistor connected to 485 terminals on the terminal block of the VFD is set incorrectly.

## Appendix A Expansion cards

### A.1 Dimensions and installation

All expansion cards are of the same dimensions (108 mm × 39 mm) and can be installed in the same way.

Comply with the following operation principles when installing or removing an expansion card:

1. Ensure that no power is applied before installing an expansion card.
2. An expansion card can be installed into a respective card slots among SLOT1, SLOT2, and SLOT3.
3. VFDs of 5.5 kW or lower can be configured with two expansion cards at the same time, and those of 7.5 kW or higher can be configured with three expansion cards.
4. If interference occurs on the external wires after expansion cards are installed, change their installation card slots flexibly to facilitate the wiring.
5. To ensure high anti-interference capability in closed-loop control, you need to use a shielded cable as the encoder cable and ground the two ends of the cable. That is, connect the motor side shield layer to the motor housing, and connect the PG card side shield layer to the PE terminal.

**Note:** For 2.2–5.5kW models, the 24V power supply card can be inserted into SLOT1; for 7.5kW and higher models, the 24V power supply card can be inserted into SLOT1 or SLOT3; for 11kW and higher models, the 24V power supply card can be inserted into any of the three slots.

Figure A-1 shows the installation diagram and a VFD with expansion cards installed.

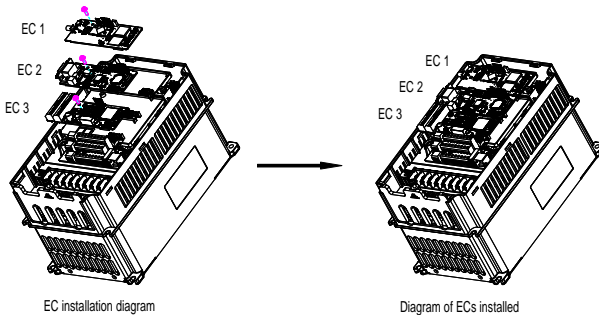

Figure A-1 VFD of 7.5 kW or higher with expansion cards installed

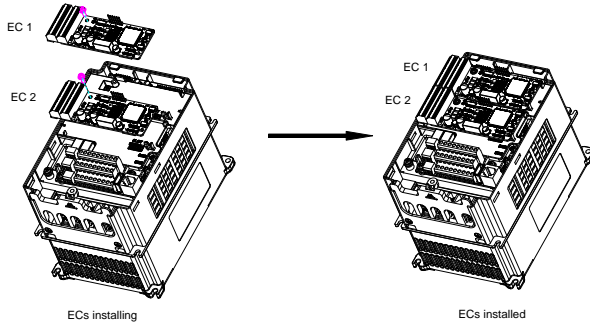

Figure A-2 VFD of 5.5 kW or lower with expansion cards installed

Expansion card installation process:

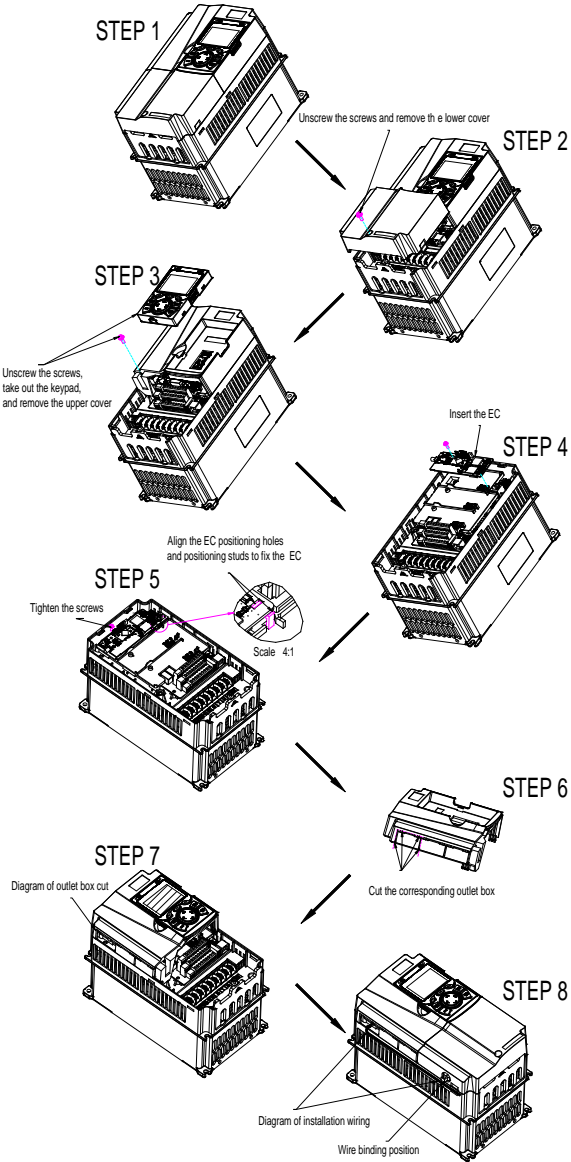

Figure A-3 Expansion card installation process diagram

## A.2 Wiring

1. Ground a shielded cable as follows:

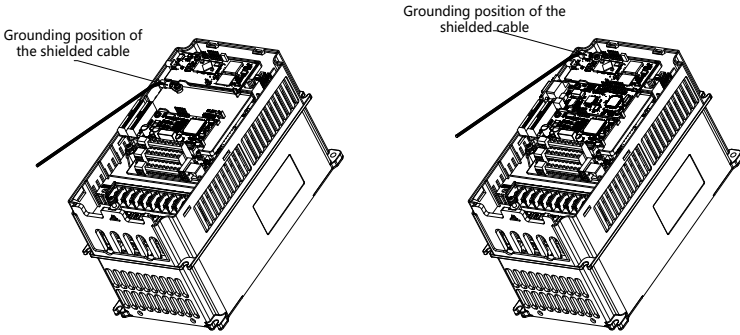

Figure A-4 Expansion card grounding diagram

2. Wire an expansion card as follows:

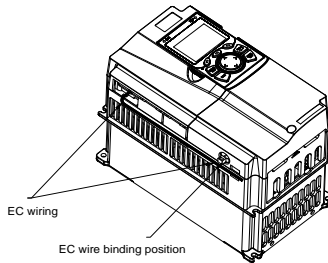
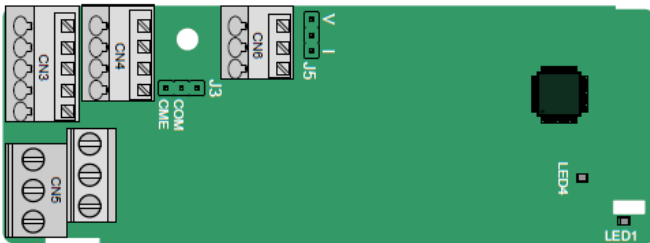

Figure A-5 Expansion card wiring

## A.3 IO cards

### A.3.1 IO Card (UMI-S0170)



CME and COM are shorted through J3 before delivery, and J5 is the jumper for selecting the output type (voltage or current) of AO2.

The terminals are arranged as follows:

AI3	AO2	GND
-----	-----	-----

COM	CME	Y2	S5		RO3A	RO3B	RO3C
PW	+24V	S6	S7	S8	RO4A		RO4C

**Indicator definition**

Indicator	Name	Description
LED1	State indicator	On: The expansion card is establishing a connection with the control board. Blinking periodically: The expansion card is properly connected to the control board (the period is 1s, on for 0.5s, and off for the other 0.5s). Off: The expansion card is disconnected from the control board.
LED4	Power indicator	On: The control board feeds power to the expansion card.

The UMI-S0170 expansion card can be used in scenarios where the I/O interfaces of a UMI-B7 VFD cannot meet the application requirements. It can provide 4 digital inputs, 1 digital output, 1 analog input, 1 analog output, and 2 relay outputs. It is user-friendly, providing relay outputs through European-type screw terminals and other inputs and outputs through spring terminals.

**UMI-S0170 terminal function description**

Category	Symbol	Name	Description
Power	PW	External power supply	The working power of digital input is provided by an external power supply. Voltage range: 12–30 V The terminals PW and +24V are shorted before delivery.
Analog input/output	AI3—GND	Analog input 1	1. Input range: 0–10 V, 0–20 mA 2. Input impedance: 20 kΩ for voltage input; 250 Ω for current input 3. Set it to be voltage or current input through the corresponding function code. 4. Resolution: When 10 V corresponds to 50 Hz, the minimum resolution is 5 mV. 5. Deviation: ±0.5%; input of 5 V or 10 mA or higher at the temperature of 25°C
	AO2—GND	Analog output 1	1. Output range: 0–10 V, 0–20 mA 2. Whether it is voltage or current output is determined by J5. 3. Deviation ±0.5%; output of 5 V or 10 mA or higher at the temperature of 25°C



Category	Symbol	Name	Description
Digital input/output	S5—COM	Digital input 1	1. Internal impedance: 3.3 kΩ 2. Power input range: 12–30 V 3. Bidirectional input terminal 4. Max. input frequency: 1 kHz
	S6—COM	Digital input 2	
	S7—COM	Digital input 3	
	S8—COM	Digital input 4	
	Y2—CME	Digital output	1. Switch capacity: 50 mA/30 V 2. Output frequency range: 0–1 kHz 3. The terminals CME and COM are shorted through J3 before delivery.
Relay output	RO3A	NO contact of relay 3	1. Contact capacity: 3A/AC 250 V, 1A/DC 30 V 2. Do not use them as high-frequency digital outputs.
	RO3B	NC contact of relay 3	
	RO3C	Common contact of relay 3	
	RO4A	NO contact of relay 4	
	RO4C	Common contact of relay 4	

## A.4 Communication cards

### A.4.1 CANopen communication card (UMI-S0006)

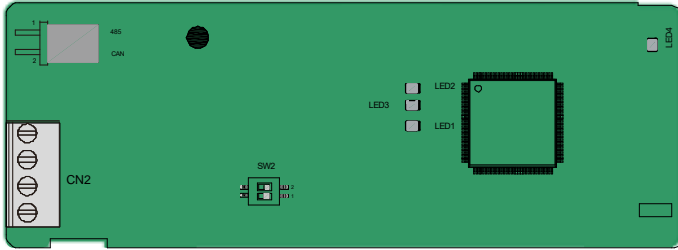

The UMI-S0006 communication card is user-friendly, adopting spring terminals.

Symbol	Description	
PGND	Isolation ground	Isolation ground
PE	Shielded	CAN bus shielding
CANH	CANopen bus high level signal	CAN bus high level signal
CANL	CANopen bus low level signal	CAN bus low level signal
CAN	CAN terminal resistor switch	ON: A terminal resistor of 120 Ω is connected between CAN_H and CAN_L are connected to a terminal resistor of 120 Ω.
		OFF: No terminal resistor is connected between CAN_H and CAN_L.

**Note:** Before power-on, please select the protocol type by setting the switch SW2 as follows:

Switch SW2		
1	2	Protocol type
OFF	OFF	CANopen
ON	OFF	CAN master/slave

#### Indicator definition

Indicator No.	Definition	Function
LED1	State indicator	On: The expansion card is establishing a connection with the control board. Blinking periodically: The expansion card is properly connected to the control board (the period is 1s, on for 0.5s, and off for the other 0.5s). Off: The expansion card is disconnected from the control board.
LED2	Running indicator	On: The communication card is running. Off: A fault occurs. Check whether the reset pin

Indicator No.	Definition	Function
		of the communication card and the power supply are properly connected. Blinks: The communication card is in the pre-operation state. Blinks once: The communication card is in the stopped state.
LED3	Error indicator	On: The CAN controller bus is off or a fault occurs on the VFD. Off: The communication card is in the working state.
LED4	Power indicator	On: The control board feeds power to the communication card.

For details about the operation, see the *Communication Card Operation Manual*.

**A.4.2 Ethernet/IP communication card (UMI-S0007) and Modbus TCP communication card (UMI-S0009)**

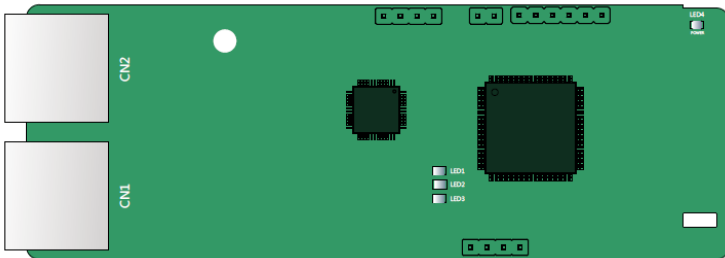

The terminal CN2 adopts standard dual RJ45 interfaces, and the two RJ45 interfaces are not distinguished from each other and can be interchangeably inserted.



Figure A-6 Standard RJ45 interface

**Standard RJ45 interface functions**

Pin	Name	Description
1	TX+	Transmit Data+
2	TX-	Transmit Data-
3	RX+	Receive Data+
4	n/c	Not connected
5	n/c	Not connected

Pin	Name	Description
6	RX-	Receive Data-
7	n/c	Not connected
8	n/c	Not connected

**State indicators**

The communication card provides four LED indicators and four net port indicators to indicate its states.

LED	Color	State	Description
LED1	Green	On	The card is shaking hands with the VFD.
		Blinking (1Hz)	The card and VFD communicate normally.
		Off	The card and VFD communicate improperly.
LED2	Green	On	The communication between the card and PLC is online and data interchange is allowed.
		Blinking (1Hz)	IP address conflict between the card and PLC.
		Off	The communication between the card and PLC is offline.
LED3	Red	On	Failed to set up I/O between the card and PLC.
		Blinking (1Hz)	Incorrect PLC configuration.
		Blinking (2Hz)	The card failed to send data to the PLC.
		Blinking (4Hz)	The connection between the card and PLC timed out.
		Off	No fault.
LED4	Red	On	3.3V power indicator.
Net port indicator	Yellow	On	Link indicator, indicating successful Ethernet connection.
		Off	Link indicator, indicating Ethernet connection not established.
Net port indicator	Green	On	ACK indicator, indicating data interchange being performed.
		Off	ACK indicator, indicating data interchange not be performed.

**Electrical wiring**

The communication card provides standard RJ45 ports and supports the linear, star, and ring topologies. The following three figures show the electrical wiring methods.

Use CAT5, CAT5e, and CAT6 network cables for electrical wiring. When the communication distance is greater than 50 meters, use high-quality network cables that meet the high-quality standards.

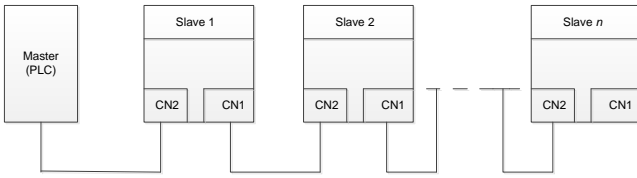

Figure A-7 Electrical wiring for a linear topology

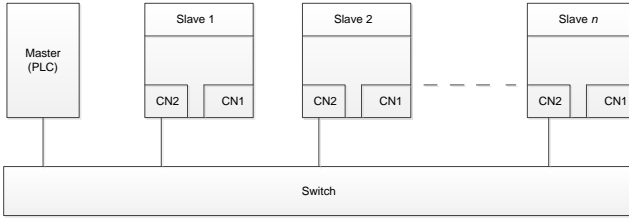

Figure A-8 Electrical wiring for a star topology

**Note:** Ethernet switches must be available when the star topology is used.

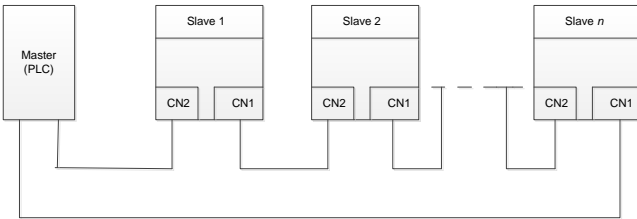
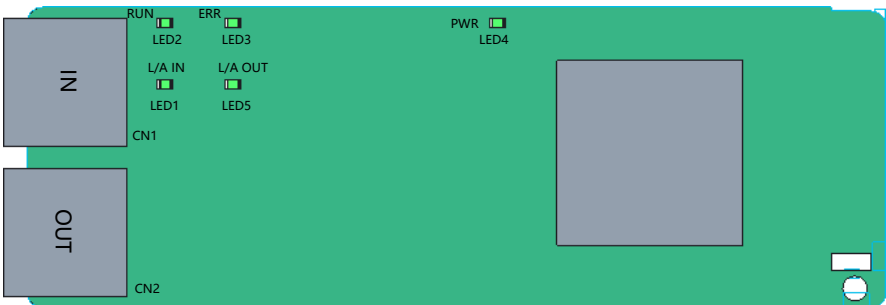

Figure A-9 Electrical wiring for a ring network

### A.4.3 EtherCAT communication card (UMI-S0008)



Standard RJ45 ports are used in EtherCAT communication. The communication card provides two RJ45 ports with transmission direction defined. Figure A-10 shows the ports. IN (indicating input) and OUT (indicating output) are EtherCAT wiring network ports. Table A-1 describes the port pins.

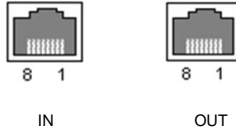

Figure A-10 RJ45 ports

**State indicators**

The EtherCAT communication card provides five LED indicators and four net port indicators to indicate its states. Figure A-11 shows the state indicator positions. Table A-1 describes the state indicators.

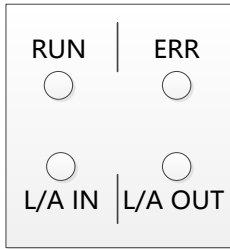

Figure A-11 State indicator positions

Table A-1 State indicators

Item	Color	Function description
RUN	Green	The green indicator indicates EtherCAT running state. Init state: It remains off. Pre-OP state: It blinks off 0.2s and on 0.2s (Blinking). Safe-OP state: It flashes off 1s and on 0.2s (Single flash). OP state: It remains on.
ERR	Red	The red indicator indicates EtherCAT fault state. No fault: It remains off. Init or Pre-OP state: It blinks off 0.2s and on 0.2s (Blinking). Safe-OP fault state: It flashes off 1s and on 0.2s (Single flash). OP state: It remains on. Process data watchdog timeout: (Double flash).
L/A IN	Green	Off: Without connection. On: With connection but inactive. Flickers: With connection and active (Flickering).
L/A OUT	Green	Off: Without connection. On: With connection but inactive. Flickers: With connection and active (Flickering).
PWR	Red	3.3V power indicator
Net port indicator (IN)	Yellow	Off: Indicates that Ethernet connection is not established. On: Indicates that Ethernet connection is established successfully.
	Green	Off: Without connection On: With connection but inactive Blinks: With connection and active
Net port indicator (OUT)	Yellow	Off: Indicates that Ethernet connection is not established. On: Indicates that Ethernet connection is established successfully.
	Green	Off: Without connection.

Item	Color	Function description
		On: With connection but inactive. Blinks: With connection and active.

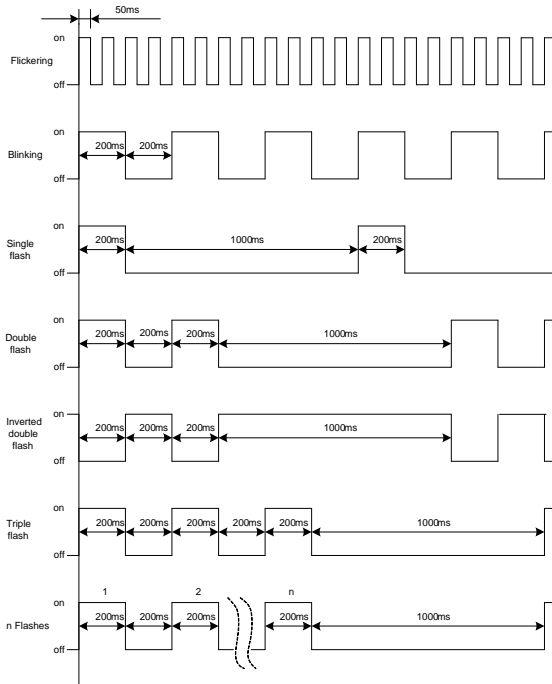

Figure A-12 Indicator flashing/blinking/flickering frequency

**Electrical wiring**

The EtherCAT network usually consists of a master station (PLC) and several slave stations (drives or bus extension terminals). Each EtherCAT slave station is configured with two standard Ethernet interfaces, and the electrical wiring diagram is shown in Figure A-13. The network also supports the star topology, which requires professional switches.

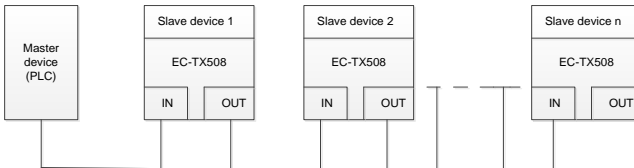
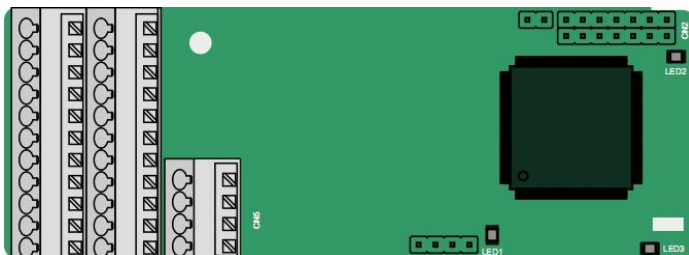

Figure A-13 Electrical wiring diagram for a linear topology

## A.5 PG cards

### A.5.1 Sin/Cos PG card (UMI-S0014)



The terminals are arranged as follows:

							C1+	C1-	D1+	D1-
PE	AO+	BO+	ZO+	A1+	B1+	R1+	A2+	B2+	Z2+	PWR
GND	AO-	BO-	ZO-	A1-	B1-	R1-	A2-	B2-	Z2-	GND

#### Indicator definition

Indicator	Name	Description
LED1	Disconnection indicator	Off: A1 and B1 of the encoder are disconnected. Blinking: C1 and D1 of the encoder are disconnected. On: The encoder signals are normal.
LED2	Power indicator	On: The control board feeds power to the PG card.
LED3	State indicator	On: The expansion card is establishing a connection with the control board. Blinking periodically: The expansion card is properly connected to the control board (the period is 1s, on for 0.5s, and off for the other 0.5s). Off: The expansion card is disconnected from the control board.

#### UMI-S0014 terminal function description

Signal	Port	Function
PWR	Encoder power	Voltage: 5 V ± 5%
GND		Max. output current: 150 mA
A1+	Encoder interface	1. Supporting Sin/Cos encoders 2. SINA/SINB/SINC/SIND 0.6–1.2Vpp; SINR 0.2–0.85Vpp 3. Max. frequency response of A/B signals: 200 kHz Max. frequency response of C/D signals: 1 kHz
A1-		
B1+		
B1-		
R1+		



Signal	Port	Function
R1-		
C1+		
C1-		
D1+		
D1-		
A2+	Pulse reference	1. Supporting 5V differential signal 2. Frequency response: 200 kHz
A2-		
B2+		
B2-		
Z2+		
Z2-		
AO+	Frequency-divided output	1. Differential output of 5 V 2. Supporting frequency division of $2^N$ , which can be set through P20.16 or P24.16; Max. output frequency: 200 kHz
AO-		
BO+		
BO-		
ZO+		
ZO-		

The following figure shows the external wiring of the PG card when it is used in combination with an encoder without CD signals.

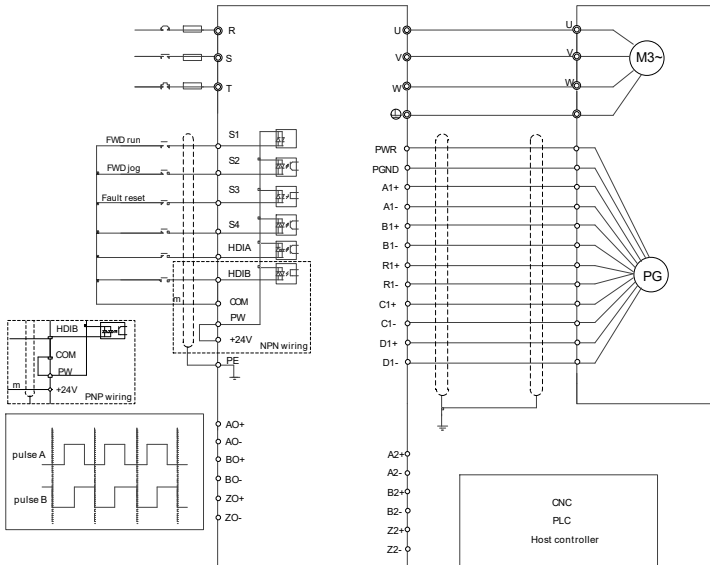

The following figure shows the external wiring of the PG card when it is used in combination with an  
-353-

encoder with CD signals.

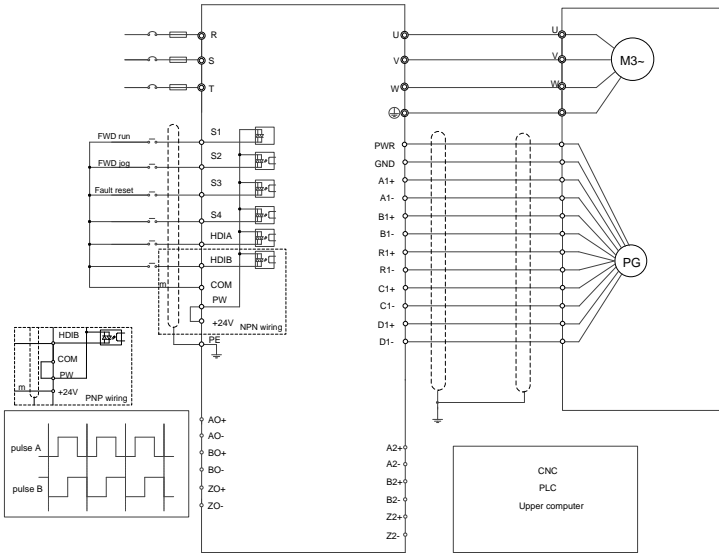

**A.5.2 Resolver PG card (UMI-S0013)**



PE	AO+	BO+	ZO+	EX+	SI+	CO+	A2+	B2+	Z2+	PWR
GND	AO-	BO-	ZO-	EX-	SI-	CO-	A2-	B2-	Z2-	GND

**Indicator definition**

Indicator	Name	Description
LED1	State indicator	On: The expansion card is establishing a connection with the control board. Blinking periodically: The expansion card is properly connected to the control board (the period is 1s, on for 0.5s, and off for the other 0.5s). Off: The expansion card is disconnected from the control board.

Indicator	Name	Description
LED2	Disconnection indicator	Off: The encoder is disconnected. On: The encoder signals are normal. Blinks: The encoder signals are not stable.
LED3	Power indicator	On: The control board feeds power to the PG card.

The UMI-S0013 expansion card can be used in combination with a resolver of excitation voltage 7 Vrms. It is user-friendly, adopting spring terminals.

**UMI-S0013 terminal function description**

Signal	Port	Description
SI+	Encoder signal input	Recommended resolver transformation ratio: 0.5
SI-		
CO+		
CO-		
EX+	Encoder excitation signal	1. Factory setting of excitation: 10 kHz 2. Supporting resolvers with an excitation voltage of 7 Vrms
EX-		
A2+	Pulse setting	1. Differential input of 5 V 2. Response frequency: 200 kHz
A2-		
B2+		
B2-		
Z2+		
Z2-		
AO+	Frequency-divided output	1. Differential output of 5 V 2. Frequency-divided output of resolver simulated A1, B1, and Z1, which is equal to an incremental PG card of 1024 pps. 3. Supporting frequency division of 2 <sup>N</sup> , which can be set through P20.16 or P24.16 4. Max. output frequency: 200 kHz
AO-		
BO+		
BO-		
ZO+		
ZO-		

The following figure shows the external wiring of the UMI-S0013 expansion card.

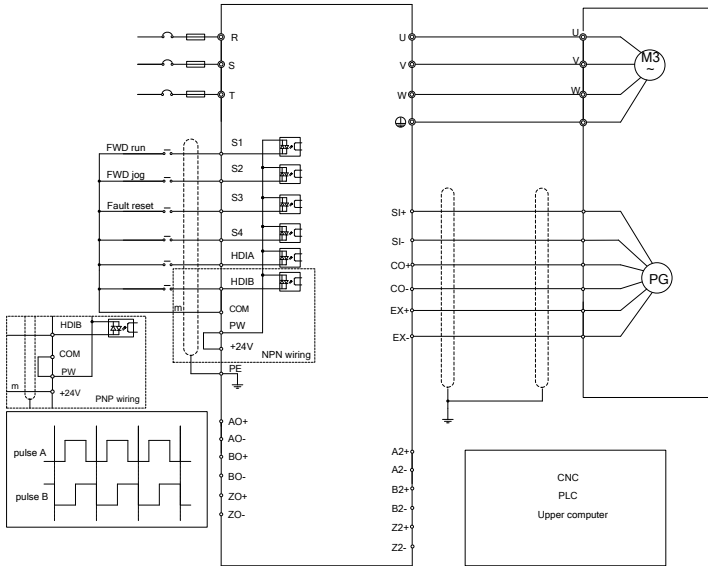

**A.5.3 Multifunction incremental PG card (UMI-S0011)**



The terminals are arranged as follows:

The switch SW1 is used to set the voltage class (5 V or 12 V) of the power supply of the encoder. The DIP switch can be operated with an auxiliary tool.

PE	AO+	BO+	ZO+	A1+	B1+	Z1+	A2+	B2+	Z2+	PWR
GND	AO-	BO-	ZO-	A1-	B1-	Z1-	A2-	B2-	Z2-	PGND

**Indicator definition**

Indicator	Name	Description
LED1	Signal indicator	Blinking (on for 500ms, off for 500ms): A1 or B1 signal is disconnected during encoder rotating. On: in other states.
LED2	Power indicator	On: The expansion card is powered on. Off: The expansion card is not powered on.

Indicator	Name	Description
LED3	State indicator	<p>On: The expansion card is establishing a connection with the control board.</p> <p>Blinking (on for 500ms, off for 500ms): The expansion card is properly connected to the control board.</p> <p>Off: The expansion card is disconnected from the control board.</p>

The UMI-S0011 expansion card can be used in combination with multiple types of incremental encoders through different modes of wiring. It is user-friendly, adopting spring terminals.

**UMI-S0011 terminal function description**

Signal	Port	Description
PWR	Encoder power	Voltage: 5 V/12 V ±5% Max. output: 150 mA Select the voltage class through the switch SW1 based on the voltage class of the used encoder.
PGND		
A1+	Encoder interface	1. Supporting push-pull interfaces of 5 V/12 V 2. Supporting open collector interfaces of 5 V/12 V 3. Supporting differential interfaces of 5 V 4. Response frequency: 400 kHz
A1-		
B1+		
B1-		
Z1+		
Z1-		
A2+	Pulse setting	1. Supporting the same signal types as the encoder signal types 2. Response frequency: 400 kHz
A2-		
B2+		
B2-		
Z2+		
Z2-		
AO+	Frequency-divided output	1. Differential output of 5 V 2. Supporting frequency division of 1–255, which can be set through P20.16 or P24.16
AO-		
BO+		
BO-		
ZO+		
ZO-		

The following figure shows the external wiring of the expansion card used in combination with an open collector encoder. A pull-up resistor is configured inside the PG card.

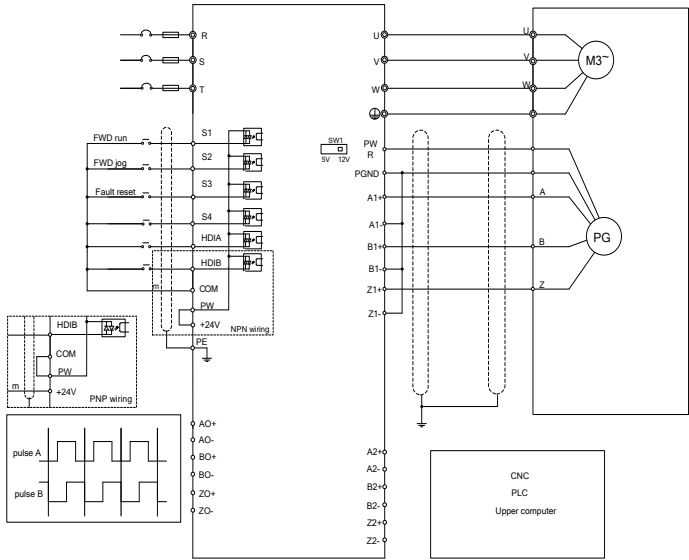

The following figure shows the external wiring of the expansion card used in combination with a push-pull encoder.

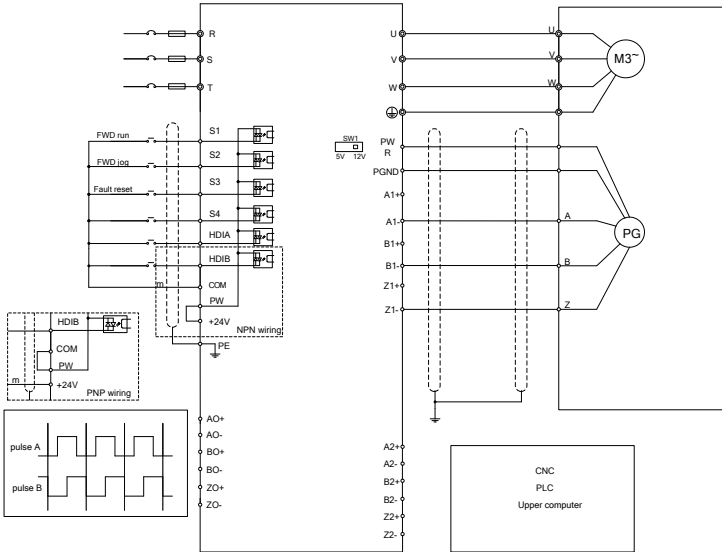

The following figure shows the external wiring of the expansion card used in combination with a differential encoder.

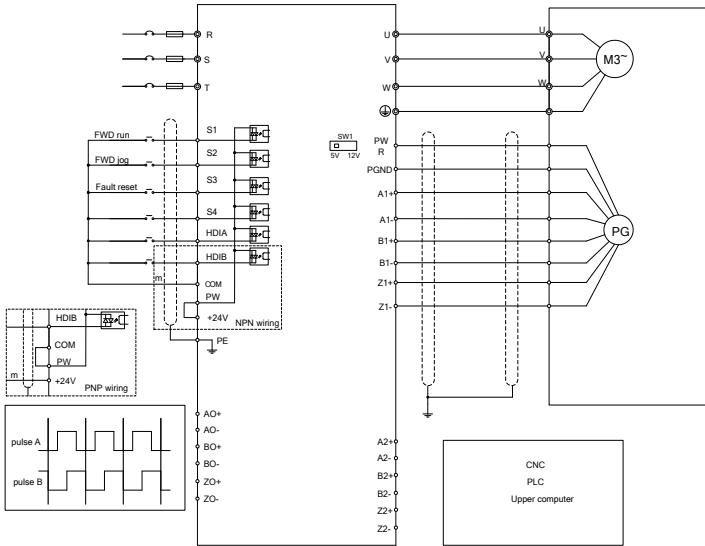

**A.5.4 24V incremental PG card (UMI-S0010)**

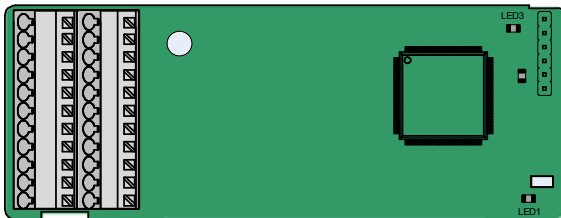

The terminals are arranged as follows:

PE	AO+	BO+	ZO+	A1+	B1+	Z1+	A2+	B2+	Z2+	PWR
GND				A1-	B1-	Z1-	A2-	B2-	Z2-	PGND

**Indicator definition**

Indicator	Name	Description
LED1	Signal indicator	Blinking (on for 500ms, off for 500ms): A1 or B1 signal is disconnected during encoder rotating. On: in other states.
LED2	Power indicator	On: The expansion card is powered on. Off: The expansion card is not powered on.

Indicator	Name	Description
LED3	State indicator	<p>On: The expansion card is establishing a connection with the control board.</p> <p>Blinking (on for 500ms, off for 500ms): The expansion card is properly connected to the control board.</p> <p>Off: The expansion card is disconnected from the control board.</p>

UMI-S0010 can work in combination with multiple types of incremental encoders through various external wiring modes. It is user-friendly, adopting spring terminals. AO-, BO-, AND ZO- are internally short connected to PGND.

**UMI-S0010 terminal function description**

Signal	Port	Description
PWR	Encoder power supply	Voltage: 24 V ± 5%
PGND		Max. output current: 150 mA
A1+	Encoder interface	<ol style="list-style-type: none"> <li>Supporting 24 V push-pull interfaces</li> <li>Supporting 24 V open collector interfaces</li> <li>Supporting 24V differential interfaces</li> <li>Frequency response: 400 kHz</li> </ol>
A1-		
B1+		
B1-		
Z1+		
Z1-		
A2+	Pulse reference	<ol style="list-style-type: none"> <li>Supporting 24 V push-pull and open collector interfaces</li> <li>Supporting 5V differential interfaces</li> <li>Frequency response: 400 kHz</li> </ol>
A2-		
B2+		
B2-		
Z2+		
Z2-		
AO+	Frequency-divided output	<ol style="list-style-type: none"> <li>Supporting open collector output. The input is externally connected with the pull-up resistor.</li> <li>Supporting frequency division of 1–255, which can be set through P20.16 or P24.16</li> <li>Supporting frequency division output source, which can be set through P20.17 or P24.17.</li> </ol>
BO+		
ZO+		

The following figure shows the external wiring of the PG card when it is used in combination with an open collector encoder. A pull-up resistor is configured in the PG card.



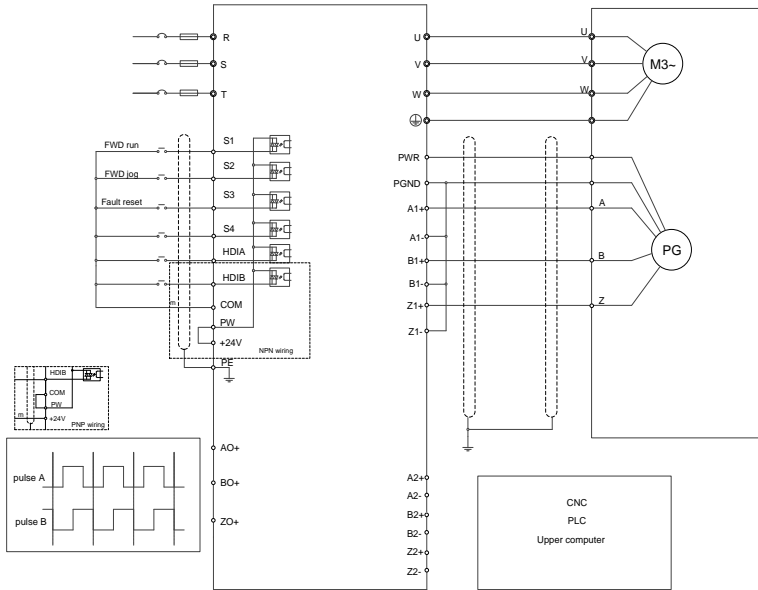

The following figure shows the external wiring of the PG card when it is used in combination with a push-pull encoder.

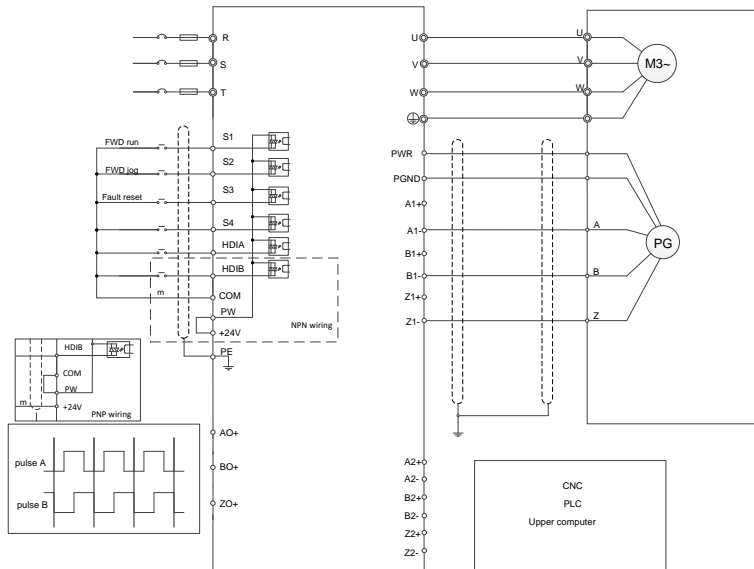

## Appendix B Technical data

### B.1 What this chapter contains

This chapter describes the technical data of the VFD and its compliance to CE and other quality certification systems.

### B.2 Derated application

#### B.2.1 Capacity

Choose a VFD based on the rated current and power of the motor. To endure the rated power of the motor, the rated output current of the VFD must be larger or equal to the rated current of the motor. The rated power of the VFD must be higher or equal to that of the motor.

**Note:**

- The maximum allowable shaft power of the motor is limited to 1.5 times the rated power of the motor. If the limit is exceeded, the VFD automatically restricts the torque and current of the motor. This function effectively protects the input shaft against overload.
- The rated capacity is the capacity at the ambient temperature of 40°C.
- You need to check and ensure that the power flowing through the common DC connection in the common DC system does not exceed the rated power of the motor.

#### B.2.2 Derating

If the ambient temperature at the VFD installation site exceeds 40°C, the VFD installation site altitude exceeds 1000m, a cover with heat dissipation vents is used, or the carrier frequency is higher than the recommended, the VFD needs to be derated.

##### B.2.2.1 Derating due to temperature

When the temperature ranges from 40°C to 50°C, the rated output current is derated by 1% for each increase of 1°C.

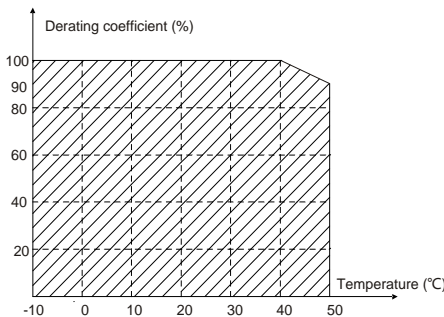

**Note:** It is not recommended to use the VFD at an environment with the temperature higher than 50°C. In case of violation, we shall bear no liability for the consequences caused.

##### B.2.2.2 Derating due to altitude

When the altitude of the site where the VFD is installed is lower than 1000 m, the VFD can run at the

rated power. When the altitude exceeds 1000m, derate 1% for every additional 100m.

### B.2.2.3 Derating due to carrier frequency

The VFDs in different power classes are different in carrier frequency. The rated power of a VFD is defined based on the carrier frequency set in factory. If the carrier frequency exceeds the factory setting, the power of the VFD is derated by 10% for each increased 1 kHz.

VFD model	Rated power (kW)	Carrier frequency													
		2kHz	3kHz	4kHz	5kHz	6kHz	7kHz	8kHz	9kHz	10kHz	11kHz	12kHz	13kHz	14kHz	15kHz
UMI-0007CU-B7	0.75	100.0%	100.0%	100.0%	100.0%	100.0%	100.0%	100.0%	93.8%	88.4%	83.3%	78.7%	74.4%	70.0%	66.7%
UMI-0015CU-B7	1.5	100.0%	100.0%	100.0%	100.0%	100.0%	100.0%	100.0%	100.0%	100.0%	100.0%	100.0%	100.0%	100.0%	99.7%
UMI-0022CU-B7	2.2	100.0%	100.0%	100.0%	100.0%	100.0%	100.0%	100.0%	94.5%	89.5%	85.0%	80.5%	76.5%	73.0%	69.6%
UMI-0040CU-B7	4	100.0%	100.0%	100.0%	100.0%	100.0%	100.0%	100.0%	94.5%	89.4%	84.7%	80.4%	76.4%	72.7%	68.8%
UMI-0055CU-B7	5.5	100.0%	100.0%	100.0%	100.0%	100.0%	100.0%	100.0%	94.1%	88.8%	83.8%	79.3%	75.0%	71.1%	67.6%
UMI-0075CU-B7	7.5	100.0%	100.0%	100.0%	100.0%	100.0%	100.0%	100.0%	94.5%	89.3%	84.7%	80.3%	76.2%	72.4%	69.0%
UMI-0110CU-B7	11	100.0%	100.0%	100.0%	100.0%	100.0%	100.0%	100.0%	95.2%	90.7%	86.6%	82.6%	79.1%	75.6%	72.4%
UMI-0150CU-B7	15	100.0%	100.0%	100.0%	93.5%	87.5%	82.2%	77.3%	72.8%	68.7%	65.0%	61.6%	-	-	-
UMI-0180CU-B7	18.5	100.0%	100.0%	100.0%	93.4%	87.3%	81.9%	76.9%	72.3%	68.1%	64.3%	60.7%	-	-	-
UMI-0220CU-B7	22	100.0%	100.0%	100.0%	93.1%	86.9%	81.3%	76.1%	71.5%	67.3%	63.5%	60.0%	-	-	-
UMI-0300CU-B7	30	100.0%	100.0%	100.0%	100.0%	100.0%	98.5%	92.7%	87.6%	82.7%	78.3%	74.3%	-	-	-
UMI-0370CU-B7	37	100.0%	100.0%	100.0%	93.9%	88.1%	82.9%	78.1%	73.7%	69.6%	65.9%	62.5%	-	-	-
UMI-0450CU-B7	45	100.0%	100.0%	100.0%	93.1%	86.8%	81.1%	75.9%	71.2%	66.9%	63.0%	59.4%	-	-	-
UMI-0550CU-B7	55	100.0%	100.0%	100.0%	94.9%	90.1%	85.6%	81.5%	77.5%	73.9%	70.4%	67.2%	-	-	-
UMI-0015EU-B7	1.5	100.0%	100.0%	100.0%	100.0%	100.0%	100.0%	100.0%	92.2%	85.1%	78.9%	73.5%	68.4%	64.1%	60.3%
UMI-0022EU-B7	2.2	100.0%	100.0%	100.0%	100.0%	100.0%	100.0%	100.0%	91.6%	84.8%	78.4%	72.8%	67.6%	63.4%	59.6%
UMI-0040EU-B7	4	100.0%	100.0%	100.0%	100.0%	100.0%	100.0%	100.0%	100.0%	100.0%	100.0%	100.0%	100.0%	99.5%	93.9%
UMI-0055EU-B7	5.5	100.0%	100.0%	100.0%	100.0%	100.0%	100.0%	100.0%	93.1%	86.9%	81.3%	76.2%	71.6%	67.4%	63.6%
UMI-0075EU-B7	7.5	100.0%	100.0%	100.0%	100.0%	100.0%	100.0%	100.0%	92.6%	86.0%	80.0%	74.6%	69.9%	65.6%	61.7%
UMI-0110EU-B7	11	100.0%	100.0%	100.0%	100.0%	100.0%	100.0%	100.0%	92.3%	85.4%	79.4%	74.0%	69.2%	64.8%	60.9%
UMI-0150EU-B7	15	100.0%	100.0%	100.0%	100.0%	97.3%	88.4%	80.8%	74.1%	68.3%	63.1%	58.6%	-	-	-
UMI-0180EU-B7	18	100.0%	100.0%	100.0%	90.2%	81.6%	74.3%	67.8%	62.2%	57.4%	53.0%	49.2%	-	-	-
UMI-0220EU-B7	22	100.0%	100.0%	100.0%	100.0%	91.8%	84.4%	77.7%	71.9%	66.8%	62.1%	58.1%	-	-	-
UMI-0300EU-B7	30	100.0%	100.0%	100.0%	90.0%	81.4%	74.1%	67.8%	62.3%	57.5%	53.4%	49.7%	-	-	-
UMI-0370EU-B7	37	100.0%	100.0%	100.0%	89.7%	80.9%	73.4%	66.9%	61.3%	56.4%	52.1%	48.3%	-	-	-
UMI-0450EU-B7	45	100.0%	100.0%	100.0%	89.7%	81.0%	73.5%	67.1%	61.5%	56.7%	52.5%	48.8%	-	-	-
UMI-0550EU-B7	55	100.0%	100.0%	100.0%	100.0%	100.0%	95.6%	87.6%	80.5%	74.4%	-	-	-	-	-
UMI-0750EU-B7	75	100.0%	100.0%	97.3%	87.9%	79.9%	72.9%	66.8%	61.5%	56.8%	-	-	-	-	-
UMI-0900EU-B7	90	100.0%	100.0%	93.9%	83.9%	75.4%	68.1%	61.8%	56.4%	51.8%	-	-	-	-	-

VFD model	Rated power (kW)	Carrier frequency													
		2kHz	3kHz	4kHz	5kHz	6kHz	7kHz	8kHz	9kHz	10kHz	11kHz	12kHz	13kHz	14kHz	15kHz
UMI-1100EU-B7	110	100.0%	90.2%	81.6%	74.0%	67.4%	61.6%	56.5%	52.1%	48.1%	-	-	-	-	-
UMI-1320EU-B7	132	100.0%	100.0%	93.1%	83.5%	75.2%	68.2%	62.1%	56.9%	52.3%	-	-	-	-	-
UMI-1600EU-B7	160	100.0%	100.0%	100.0%	100.0%	93.9%	85.7%	78.8%	72.3%	66.8%	-	-	-	-	-
UMI-1850EU-B7	185	100.0%	100.0%	100.0%	92.5%	84.1%	76.9%	70.5%	64.9%	59.9%	-	-	-	-	-
UMI-2000EU-B7	200	100.0%	100.0%	91.2%	82.7%	75.3%	68.7%	63.0%	58.0%	53.6%	-	-	-	-	-
UMI-2200EU-B7	220	100.0%	100.0%	100.0%	91.3%	82.8%	75.5%	69.2%	63.6%	58.7%	-	-	-	-	-
UMI-2500EU-B7	250	100.0%	99.2%	89.2%	80.6%	73.2%	66.7%	61.1%	56.2%	51.9%	-	-	-	-	-
UMI-2800EU-B7	280	100.0%	100.0%	100.0%	91.1%	83.0%	75.9%	69.6%	64.1%	59.3%	-	-	-	-	-
UMI-3150EU-B7	315	100.0%	97.9%	88.6%	80.4%	73.3%	67.0%	61.5%	56.6%	52.3%	-	-	-	-	-
UMI-3500EU-B7	350	100.0%	99.4%	89.3%	80.6%	73.1%	66.5%	60.8%	55.9%	51.5%	-	-	-	-	-
UMI-4000EU-B7	400	100.0%	100.0%	95.1%	85.1%	76.4%	68.9%	62.4%	56.9%	51.9%	-	-	-	-	-
UMI-5000EU-B7	500	100.0%	88.9%	79.2%	70.9%	63.7%	57.4%	52.1%	47.4%	43.3%	-	-	-	-	-
UMI-0007FU-B7	0.75	100.0%	100.0%	100.0%	100.0%	100.0%	100.0%	100.0%	100.0%	100.0%	100.0%	100.0%	100.0%	100.0%	100.0%
UMI-0015FU-B7	1.5	100.0%	100.0%	100.0%	100.0%	100.0%	100.0%	100.0%	100.0%	100.0%	100.0%	100.0%	100.0%	100.0%	100.0%
UMI-0022FU-B7	2.2	100.0%	100.0%	100.0%	100.0%	100.0%	100.0%	100.0%	100.0%	100.0%	100.0%	100.0%	100.0%	100.0%	100.0%
UMI-0040FU-B7	4	100.0%	100.0%	100.0%	100.0%	100.0%	100.0%	100.0%	100.0%	100.0%	100.0%	100.0%	100.0%	100.0%	100.0%
UMI-0055FU-B7	5.5	100.0%	100.0%	100.0%	100.0%	100.0%	100.0%	100.0%	100.0%	100.0%	100.0%	100.0%	100.0%	100.0%	100.0%
UMI-0075FU-B7	7.5	100.0%	100.0%	100.0%	100.0%	100.0%	100.0%	100.0%	100.0%	100.0%	100.0%	100.0%	100.0%	100.0%	98.2%
UMI-0110FU-B7	11	100.0%	100.0%	100.0%	100.0%	100.0%	100.0%	100.0%	100.0%	100.0%	99.5%	91.6%	84.8%	78.8%	73.4%
UMI-0150FU-B7	15	100.0%	100.0%	100.0%	100.0%	100.0%	100.0%	100.0%	90.5%	82.5%	75.7%	69.7%	64.5%	59.9%	55.8%
UMI-0180FU-B7	18.5	100.0%	100.0%	100.0%	84.7%	72.9%	63.6%	56.1%	50.0%	44.9%	40.6%	37.0%	-	-	-
UMI-0220FU-B7	22	100.0%	100.0%	100.0%	85.1%	73.4%	63.9%	56.3%	50.1%	45.0%	40.7%	37.0%	-	-	-
UMI-0300FU-B7	30	100.0%	100.0%	100.0%	99.4%	86.4%	76.0%	67.2%	60.2%	54.2%	49.1%	44.7%	-	-	-
UMI-0370FU-B7	37	100.0%	100.0%	100.0%	86.0%	74.6%	65.6%	58.1%	51.9%	46.7%	42.5%	38.7%	-	-	-
UMI-0450FU-B7	45	100.0%	100.0%	100.0%	87.5%	77.1%	68.6%	61.3%	55.4%	50.2%	45.7%	41.9%	-	-	-
UMI-0550FU-B7	55	100.0%	84.9%	73.1%	63.7%	56.3%	50.0%	44.9%	40.6%	37.0%	-	-	-	-	-
UMI-0750FU-B7	75	100.0%	100.0%	87.4%	74.1%	63.9%	55.8%	49.2%	43.8%	39.3%	-	-	-	-	-
UMI-0900FU-B7	90	100.0%	100.0%	87.1%	74.5%	64.7%	56.8%	50.5%	45.3%	40.9%	-	-	-	-	-
UMI-1100FU-B7	110	100.0%	82.4%	69.3%	59.3%	51.5%	45.3%	40.2%	36.0%	32.5%	-	-	-	-	-

**B.3 Motor connection data**

<b>Motor type</b>	Asynchronous induction motor or permanent-magnet synchronous motor
<b>Voltage</b>	0–U1 (rated voltage of the motor), 3PH symmetrical, Umax (rated voltage of the VFD) at the field-weakening point
<b>Short-circuit protection</b>	The short-circuit protection for the motor output meets the requirements of IEC 61800-5-1.
<b>Frequency</b>	0–599 Hz
<b>Frequency resolution</b>	0.01 Hz
<b>Current</b>	See 3.6 Product ratings.
<b>Power limit</b>	1.5 times the rated power of the motor
<b>Carrier frequency</b>	1–15 kHz

**B.3.1 EMC compatibility and motor cable length**

The following table describes the maximum motor cable lengths that meet the requirements of the EU EMC directive (2014/30/EU).

<b>All models (with external EMC filters)</b>	<b>Maximum motor cable length (m)</b>
Environment category II (C3)	30

For description about the environments categories I (C2) and II (C3), see section **Error! Reference source not found. Error! Reference source not found.**

## Appendix C Dimensions

### C.1 What this chapter contains

This chapter describes the dimension drawings of UMI-B7 series VFDs. The dimension unit used in the drawings is mm.

### C.2 Keypad structure

#### C.2.1 Structure diagram

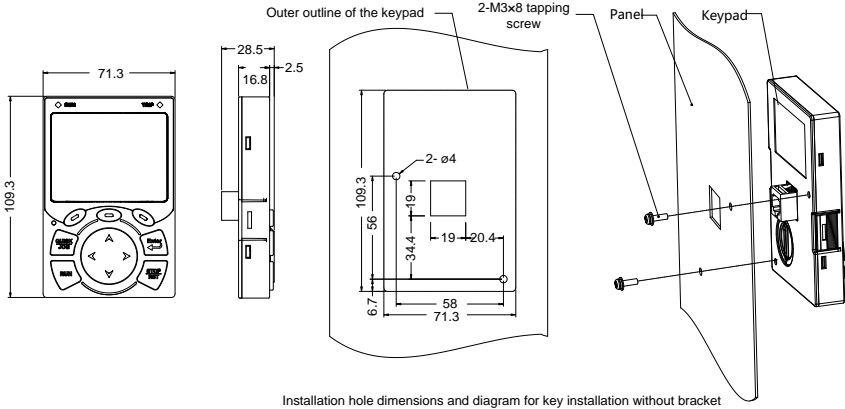

Installation hole dimensions and diagram for key installation without bracket

Figure C-1 Keypad structure diagram

#### C.2.2 Keypad installation bracket

**Note:** When installing a keypad in a position away from the VFD, you can directly use M3 threaded screws or a keypad bracket. For VFDs of 220V 0.75 to 15 kW and 460V 1.5 to 30 kW, you need to use optional keypad installation brackets. For those of 220V 18 to 55 kW, 460V 37 to 500 kW, and 575V, 18.5 to 110 kW, you can use optional brackets or use the standard keypad brackets externally.

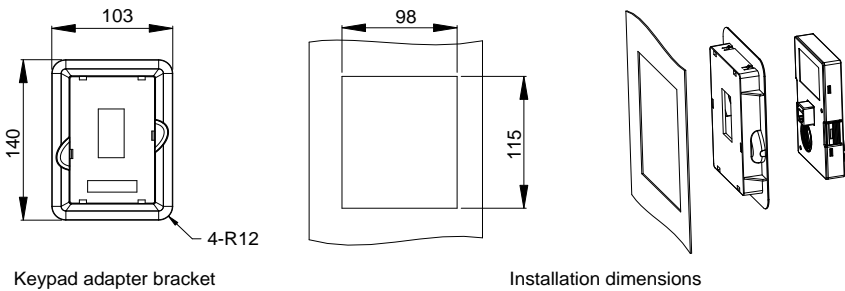

Figure C-2 Keypad installation bracket

### C.3 VFD structure

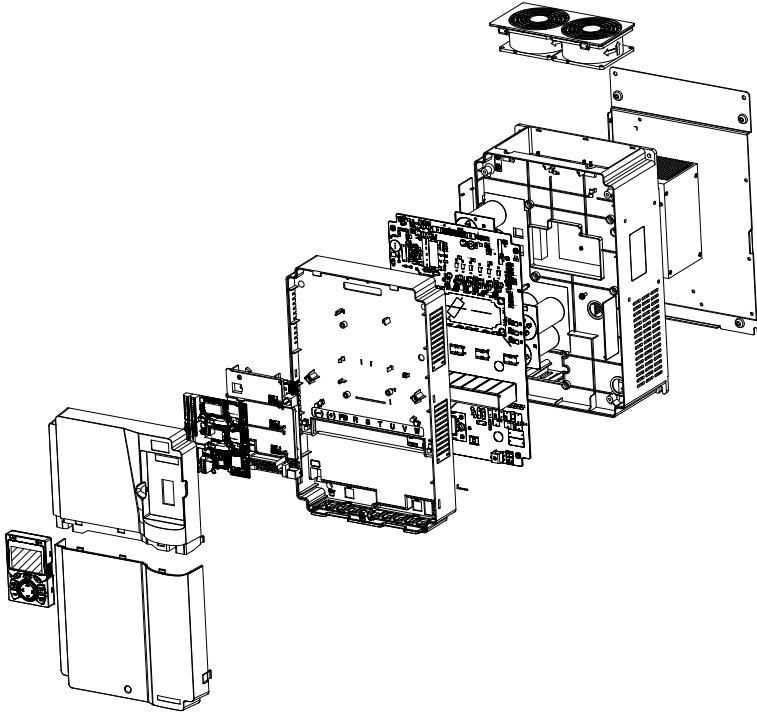

Figure C-3 VFD structure diagram

### C.4 Dimensions of VFDs of AC 3PH 200V–240V and 380V–480V

#### C.4.1 Wall installation dimensions

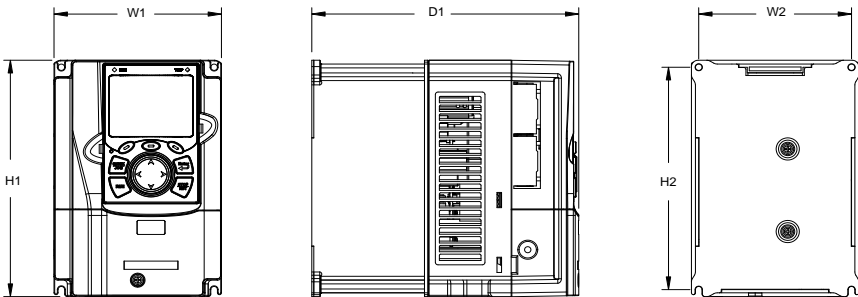

Figure C-4 Wall installation diagram of VFDs of 220V 0.75–15kW and 460V 1.5–30kW

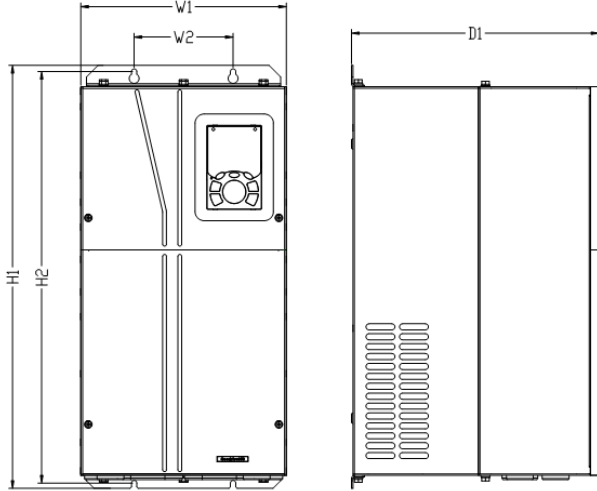

Figure C-5 Wall installation diagram of VFDs of 220V 18.5–55kW and 460V 37–55kW

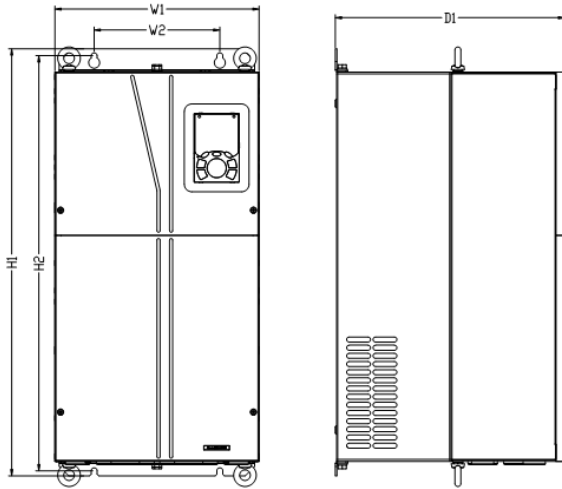

Figure C-6 Wall installation diagram of VFDs of 460V 75–110kW



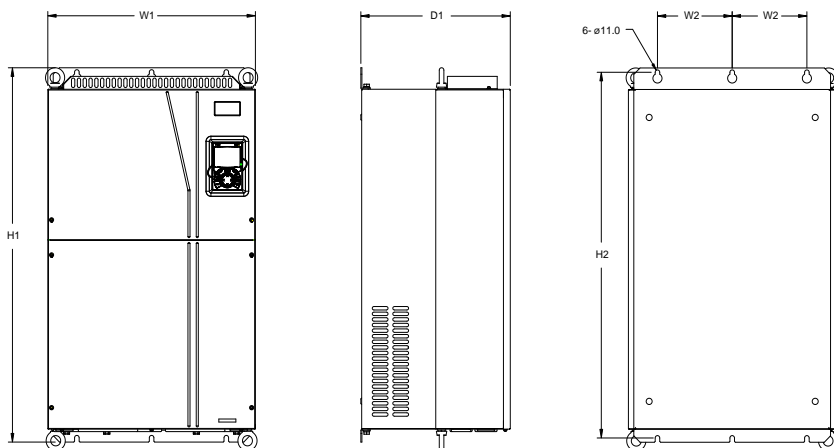

Figure C-7 Wall installation diagram of VFDs of 460V 132–200kW

Table C-1 Wall installation dimensions of 220V 0.75–55kW (unit: mm)

Model	W1	W2	H1	H2	D1	Installation hole
0.75kW	126	115	186	175	185	Ø 5
1.5kW–2.2kW	146	131	256	243.5	192	Ø 5
4kW–5.5kW	170	151	320	303.5	219	Ø 6
7.5kW	230	210	330	311	217	Ø 6
11kW–15kW	255	237	400	384	242	Ø 7
18.5kW–30kW	270	130	557	540	325	Ø 7
37kW–55kW	325	200	682	661	365	Ø 9.5

Table C-2 Wall installation dimensions of 460V VFDs (unit: mm)

Model	W1	W2	H1	H2	D1	Installation hole
1.5kW–2.2kW	126	115	186	175	185	Ø 5
4kW–5.5kW	146	131	256	243.5	192	Ø 5
7.5kW–11kW	170	151	320	303.5	219	Ø 6
15kW–18.5kW	230	210	330	311	217	Ø 6
22kW–30kW	255	237	400	384	242	Ø 7
37kW–55kW	270	130	557	540	325	Ø 7
75kW–110kW	325	200	682	661	365	Ø 9.5
132kW–200kW	500	180	872	850	360	Ø 11

C.4.2 Flange installation dimensions

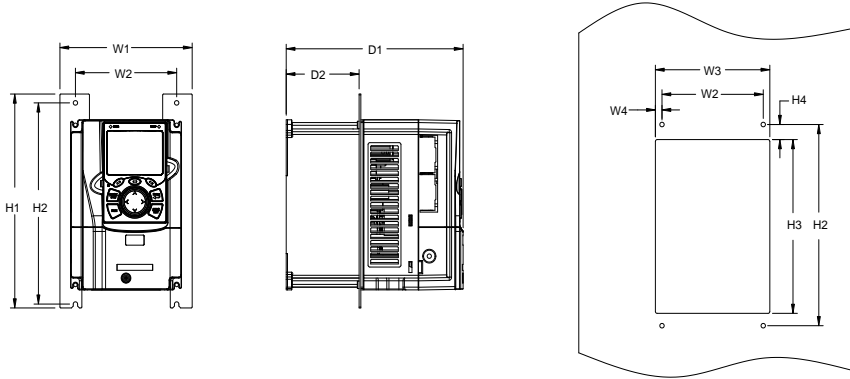

Figure C-8 Flange installation diagram of VFDs of 220V 0.75–15kW and 460V 1.5–30kW

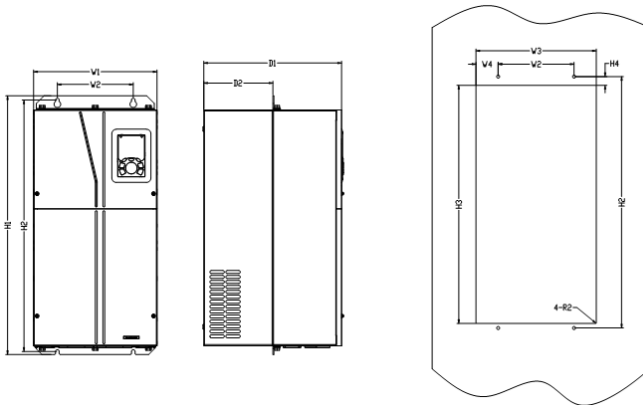

Figure C-9 Flange installation diagram of VFDs of 220V 18.5–55kW, 460V 37–55kW, and 460V 75–110kW

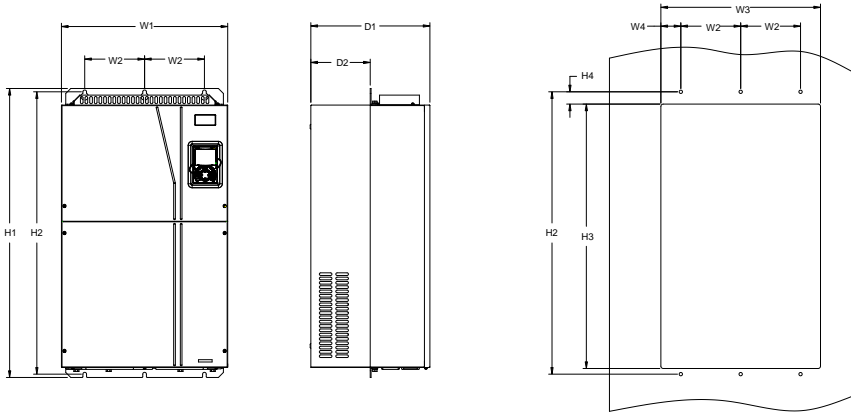

Figure C-10 Flange installation diagram of VFDs of 460V 132–200kW

Table C-3 Flange installation dimensions of 220V 0.75–55kW (unit: mm)

Model	W1	W2	W3	W4	H1	H2	H3	H4	D1	D2	Installation hole
0.7kW	150	115	130	7.5	234	220	190	16.5	185	65.5	Ø 5
1.5kW–2.2kW	170	131	150	9.5	292	276	260	10	192	79.5	Ø 6
4kW–5.5kW	191	151	174	11.5	370	351	324	15	219	113	Ø 6
7.5kW	250	210	234	12	375	356	334	10	217	108	Ø 6
11kW–15kW	275	237	259	11	445	426	404	10	242	119	Ø 7
18.5kW–30kW	270	130	261	65.5	557	540	516	17.5	325	167	Ø 7
37kW–55kW	325	200	317	58.5	682	661	626	23.5	363	182	Ø 9.5

Table C-4 Flange installation dimensions of 460V VFDs (unit: mm)

Model	W1	W2	W3	W4	H1	H2	H3	H4	D1	D2	Installation hole
1.5kW–2.2kW	150.2	115	130	7.5	234	220	190	13.5	185	65.5	Ø 5
4kW–5.5kW	170.2	131	150	9.5	292	276	260	10	192	78	Ø 5
7.5kW–11kW	191.2	151	174	11.5	370	351	324	15	219	113	Ø 6
15kW–18.5kW	250.2	210	234	12	375	356	334	10	217	108	Ø 6
22kW–30kW	275.2	237	259	11.5	445	426	404	10	242	118	Ø 6
37kW–55kW	270	130	261	65.5	557	540	516	17.5	325	167	Ø 7
75kW–110kW	325	200	317	58.5	682	661	626	23.5	363	182	Ø 9.5
132kW–200kW	500	180	480	60	872	850	796	37	358	178.5	Ø 11

C.4.3 Floor installation dimensions

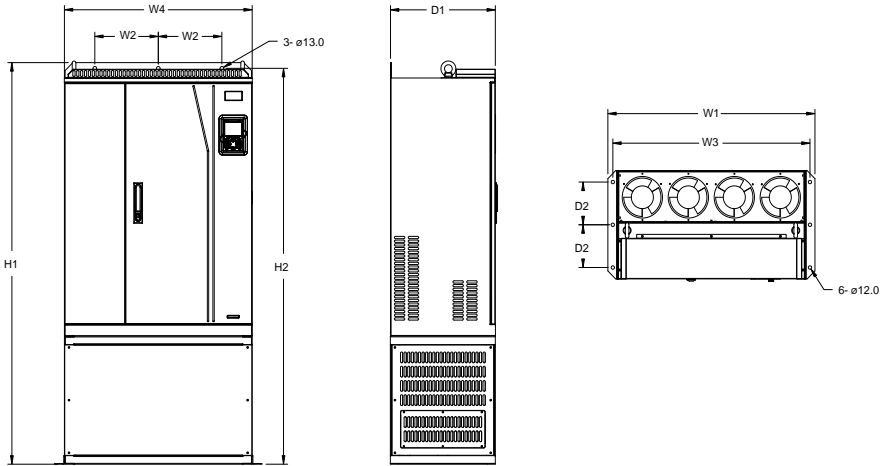

Figure C-11 Floor installation diagram of VFDs of 460V 220–315kW

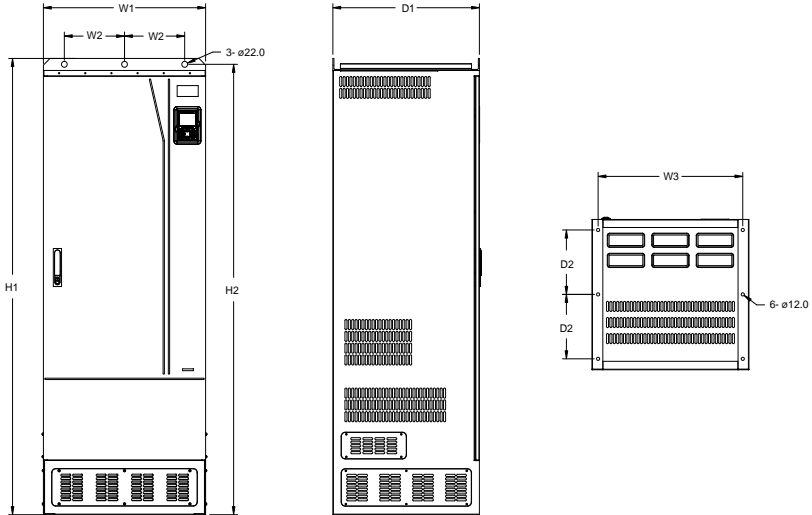

Figure C-12 Floor installation diagram of VFDs of 460V 355–500kW

Table C-5 Floor installation dimensions of 460V VFDs (unit: mm)

Model	W1	W2	W3	W4	H1	H2	D1	D2	Installation hole
220kW–315kW	750	230	714	680	1410	1390	380	150	Ø 13/12
350kW–500kW	620	230	572	-	1700	1678	560	240	Ø 22/12

**C.5 Dimensions of VFDs of AC 3PH 520V–600V**

**C.5.1 Wall installation dimensions**

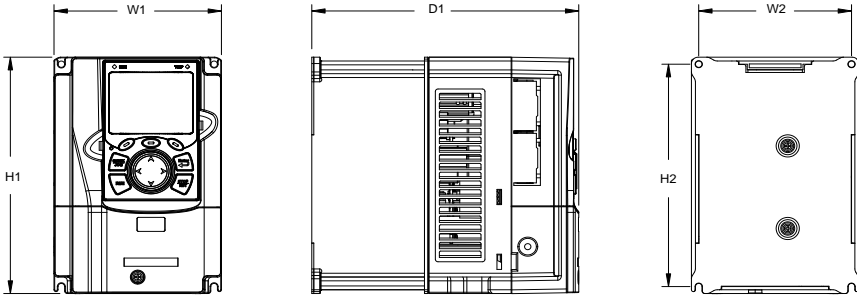

Figure C-13 Wall installation diagram of VFDs of 575V 0.75–18.5kW

Table C-6 Wall installation dimensions of VFDs of 575V 0.75–18.5kW

Model	W1	W2	W3	H1	H2	D1	Installation hole
0.75kW–2.2kW	146	131	-	256	243.5	192	Ø 5
4kW–7.5kW	170	151	-	320	303.5	219	Ø 6
11kW–18.5kW	230	210	-	330	311	217	Ø 6

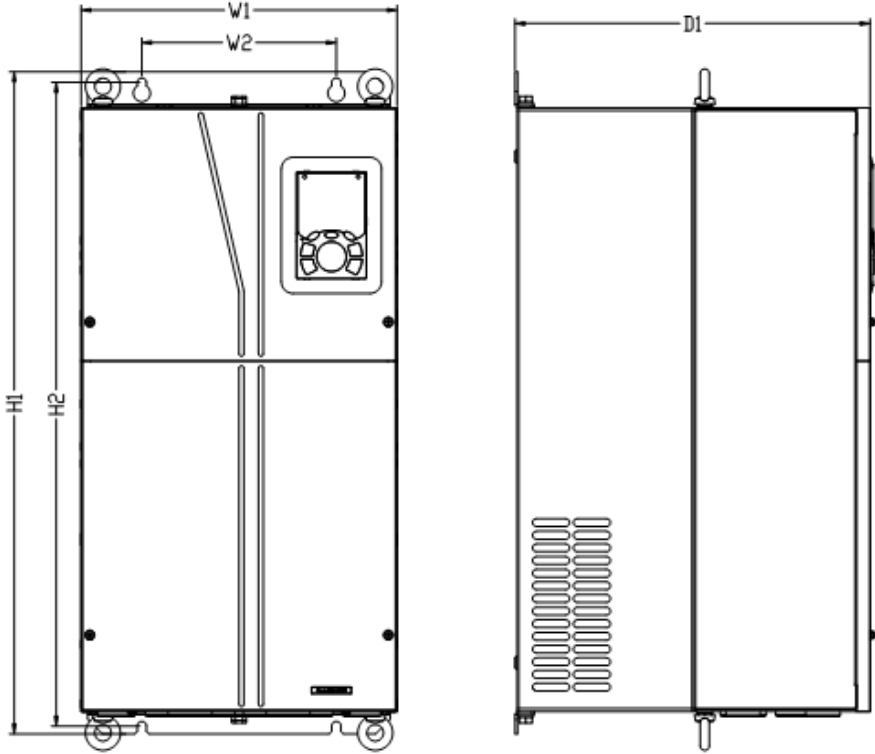

Figure C-14 Wall installation diagram of VFDs of 575V 22-110kW

Table C-7 Wall installation dimensions of VFDs of 575V 22-110kW (unit: mm)

Model	W1	W2	H1	H2	D1	Installation hole
22kW-37kW	270	130	557	540	325	Ø 7
45kW-110kW	325	200	682	661	365	Ø 9.5

**C.5.2 Flange installation dimensions**

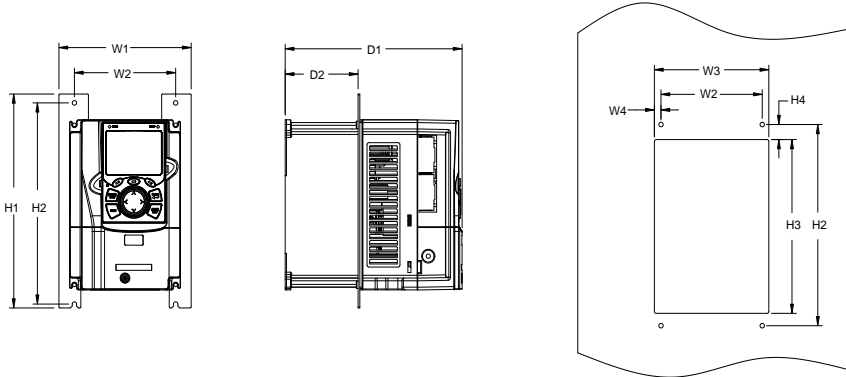

Figure C-15 Flange installation diagram of VFDs of 575V 0.75–18.5kW

Table C-8 Flange installation dimensions of VFDs of 575V 0.75–18.5kW (unit: mm)

Model	W1	W2	W3	W4	H1	H2	H3	H4	D1	D2	Installation hole
0.75kW–2.2kW	170.2	131	150	9.5	292	276	260	10	192	78	Ø 5
4kW–7.5kW	191.2	151	174	11.5	370	351	324	15	219	113	Ø 6
11kW–18.5kW	250.2	210	234	12	375	356	334	10	217	108	Ø 6

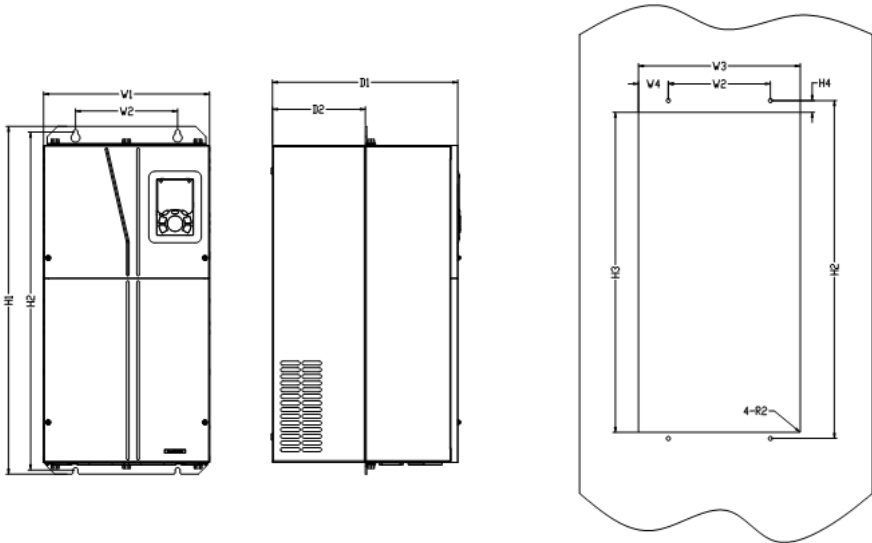

Figure C-16 Flange installation diagram of VFDs of 575V 22–110kW

Table C-9 Flange installation dimensions of VFDs of 575V 22–110kW (unit: mm)

Model	W1	W2	W3	W4	H1	H2	H3	H4	D1	D2	Installation hole
22kW–37kW	270	130	261	65.5	557	540	516	17.5	325	167	Ø 7
45kW–110kW	325	200	317	58.5	682	661	626	23.5	363	182	Ø 9.5



## Appendix D Optional peripheral accessories

### D.1 What this chapter contains

This chapter describes how to select optional accessories of UMI-B7 series VFDs.

### D.2 Wiring of peripheral accessories



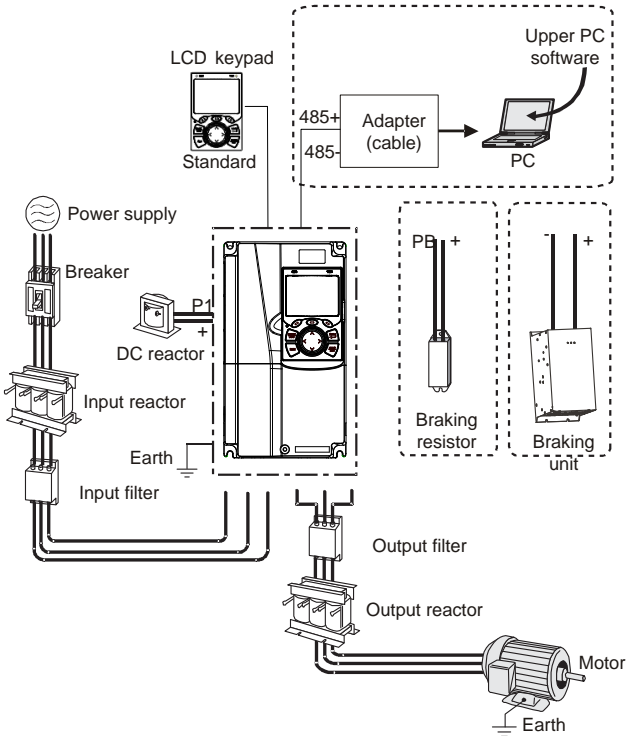

The following figure shows the external wiring of a UMI-B7 series VFD.



**Note:**

1. The VFDs of 220V ≤15kW, 460V ≤30kW, and 575V ≤18.5kW are configured with built-in braking units.
2. The VFDs of 220V 18.5–55kW, 460V ≥37kW, and 575V ≥22kW are configured with P1 terminals and can be connected to optional DC reactors and braking units.

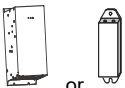
Image	Name	Description
	Cable	Accessory for signal transmission
	Breaker	Device for electric shock prevention and protection against short-to-ground that may cause current leakage

Image	Name	Description
		and fire. Select residual-current circuit breakers (RCCBs) that are applicable to VFDs and can restrict high-order harmonics, and of which the rated sensitive current for one VFD is larger than 30 mA.
	Input reactor	Accessories used to improve the current adjustment coefficient on the input side of the VFD, and thus restrict high-order harmonic currents.
	DC reactor	The VFDs of 220V 18.5–55kW, 460V ≥37kW and 575V ≥22kW can be connected to external DC reactors.
	Input filter	Accessory that restricts the electromagnetic interference generated by the VFD and transmitted to the public grid through the power cable. Try to install the input filter near the input terminal side of the VFD.
	Brake unit or braking resistor	Accessories used to consume the regenerative energy of the motor to reduce the deceleration time. The VFDs of 220V ≤15kW, 460V ≤30kW and 575V ≤18.5kW need only braking resistors and the VFDs of 220V 18.5–55kW, 460V ≥37kW and 575V ≥22kW need braking units.
	Output filter	Accessory used to restrict interference generated in the wiring area on the output side of the VFD. Try to install the output filter near the output terminal side of the VFD.
	Output reactor	Accessory used to lengthen the valid transmission distance of the VFD, which effectively restrict the transient high voltage generated during the switch-on and switch-off of the IGBT module of the VFD.

### D.3 Power supply

Refer to chapter 4 Installation guidelines.

	◇ Ensure that the voltage class of the VFD is consistent with that of the grid.
---	---

### D.4 Cables

#### D.4.1 Power cables

The sizes of the input power cables and motor cables must meet the local regulation.

- The input power cables and motor cables must be able to carry the corresponding load currents.
- The maximum temperature margin of the motor cables in continuous operation cannot be lower than 70°C.
- The conductivity of the PE grounding conductor is the same as that of the phase conductor, that is, the cross-sectional areas are the same.

- For details about the EMC requirements, see 0 Technical data.

To meet the EMC requirements stipulated in the CE standards, you must use symmetrical shielded cables as motor cables (as shown in the following figure).

Four-core cables can be used as input cables, but symmetrical shielded cables are recommended. Compared with four-core cables, symmetrical shielded cables can reduce electromagnetic radiation as well as the current and loss of the motor cables.

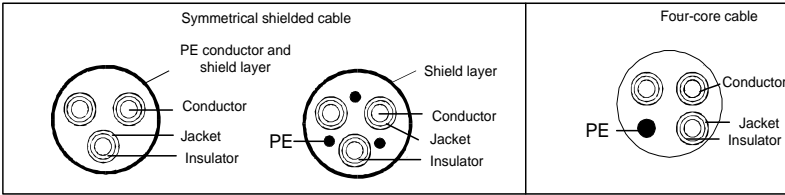

**Note:** If the conductivity of the shield layer of the motor cables cannot meet the requirements, separate PE conductors must be used.

To protect the conductors, the cross-sectional area of the shielded cables must be the same as that of the phase conductors if the cable and conductor are made of materials of the same type. This reduces grounding resistance, and thus improves impedance continuity.

To effectively restrict the emission and conduction of radio frequency (RF) interference, the conductivity of the shielded cable must at least be 1/10 of the conductivity of the phase conductor. This requirement can be well met by a copper or aluminum shield layer. The following figure shows the minimum requirement on motor cables of a VFD. The cable must consist of a layer of spiral-shaped copper strips. The denser the shield layer is, the more effectively the electromagnetic interference is restricted.

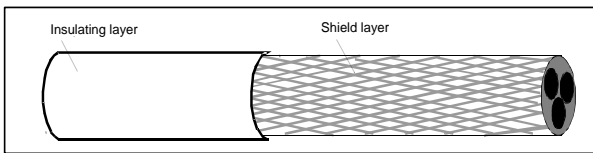

Cross-section of the cable

#### D.4.2 Control cables

All analog control cables and cables used for frequency input must be shielded cables. Analog signal cables need to be double-shielded twisted-pair cables (as shown in figure a). Use one separate shielded twisted pair for each signal. Do not use the same ground wire for different analog signals.

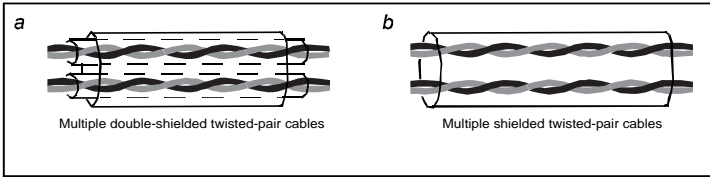

Power cable arrangement

For low-voltage digital signals, double-shielded cables are recommended, but shielded or unshielded twisted pairs (as shown in figure b) can also be used. For frequency signals, however, only shielded cables can be used.

Relay cables need to be those with metal braided shield layers.

Keypads need to be connected by using network cables. In complicated electromagnetic environments, shielded network cables are recommended.

**Note:** Analog signals and digital signals cannot use the same cables, and their cables must be arranged separately.

Do not perform any voltage endurance or insulation resistance tests, such as high-voltage insulation tests or using a megohmmeter to measure the insulation resistance, on the VFD or its components. Insulation and voltage endurance tests have been performed between the main circuit and chassis of each VFD before delivery. In addition, voltage limiting circuits that can automatically cut off the test voltage are configured inside the VFDs.

**Note:** Check the insulation conditions of the input power cable of a VFD according to the local regulations before connecting it.

VFD model	Recommended cable size (AWG)		Required torque (in-lbs)		Wire connector (##)
	R, S, T; U, V, W; P1, (+), PB, (-)	PE	R, S, T; U, V, W; P1, (+), PB, (-)	PE	
UMI-0007CU-B7	14	12	11	10	Optional
UMI-0015CU-B7	8	12	11	10	Required
UMI-0022CU-B7	8	12	11	10	Required
UMI-0040CU-B7	8	10	25	15	Optional
UMI-0055CU-B7	8	10	25	15	Optional
UMI-0075CU-B7	6	15	20	8	Required
UMI-0110CU-B7	3	8	25.5	18	Required
UMI-0150CU-B7	3	6	25.5	18	Required
UMI-0180CU-B7	2/0	6	25.5	75	Required
UMI-0220CU-B7	2/0	6	25.5	75	Required

VFD model	Recommended cable size (AWG)		Required torque (in-lbs)		Wire connector (##)
	R, S, T; U, V, W; P1, (+), PB, (-)	PE	R, S, T; U, V, W; P1, (+), PB, (-)	PE	
UMI-0300CU-B7	2/0	6	25.5	75	Required
UMI-0370CU-B7	2/0AWG	1AWG	60	10	Required
UMI-0450CU-B7	1/0 AWG x 2	1AWG	90	10	Required
UMI-0550CU-B7	1/0 AWG x 2	1AWG	90	10	Required
UMI-0015EU-B7	14AWG	12AWG	11	10	Optional
UMI-0022EU-B7	14AWG	12AWG	11	10	Optional
UMI-0040EU-B7	8AWG	12AWG	11	10	Required
UMI-0055EU-B7	8AWG	10AWG	11	10	Required
UMI-0075EU-B7	8AWG	10AWG	25	15	Optional
UMI-0110EU-B7	8AWG	10AWG	25	15	Optional
UMI-0150EU-B7	6AWG	10AWG	20	15	Required
UMI-0180EU-B7	6AWG	8AWG	20	15	Required
UMI-0220EU-B7	3AWG	8AWG	25.5	18	Required
UMI-0300EU-B7	3AWG	6AWG	25.5	18	Required
UMI-0370EU-B7	2/0	6AWG	25.5	75	Required
UMI-0450EU-B7	2/0	6AWG	25.5	75	Required
UMI-0550EU-B7	2/0	6AWG	25.5	75	Required
UMI-0750EU-B7	3/0AWG	1AWG	80	10	Required
UMI-0900EU-B7	1/0 AWG x 2	1AWG	90	10	Required
UMI-1100EU-B7	1/0 AWG x 2	1AWG	90	10	Required
UMI-1320EU-B7	350kcmil x 2	1AWG	338.2	338.2	Optional
UMI-1600EU-B7					
UMI-1850EU-B7					
UMI-2000EU-B7					
UMI-2200EU-B7	350kcmil x 3	4/0AWG	338.2	338.2	Optional
UMI-2500EU-B7					
UMI-2800EU-B7					
UMI-3150EU-B7					
UMI-3500EU-B7	350kcmil x 4	4/0AWG	338.2	338.2	Optional
UMI-4000EU-B7					
UMI-5000EU-B7					

VFD model	Recommended cable size (AWG)		Required torque (in-lbs)		Wire connector (##)
	R, S, T; U, V, W; P1, (+), PB, (-)	PE	R, S, T; U, V, W; P1, (+), PB, (-)	PE	
UMI-0007FU-B7	14AWG	14AWG	11	10	Optional
UMI-0015FU-B7	14AWG	14AWG	11	10	Optional
UMI-0022FU-B7	14AWG	14AWG	11	10	Optional
UMI-0040FU-B7	14AWG	14AWG	25	15	Optional
UMI-0055FU-B7	12AWG	12AWG	25	15	Optional
UMI-0075FU-B7	10AWG	10AWG	25	15	Optional
UMI-0110FU-B7	10AWG	10AWG	20	15	Optional
UMI-0150FU-B7	10AWG	10AWG	20	15	Optional
UMI-0180FU-B7	8AWG	10AWG	20	15	Optional
UMI-0220FU-B7	4AWG	8AWG	60	10	Required
UMI-0300FU-B7					
UMI-0370FU-B7					
UMI-0450FU-B7	3/0AWG	2AWG	60	10	Required
UMI-0550FU-B7					
UMI-0750FU-B7					
UMI-0900FU-B7					
UMI-1100FU-B7					
Control terminal block	26-14(Str/Sol) AWG	--	4.5	--	Optional

**Note:**

- It is appropriate to use the recommended cable size at 40°C and rated current. The wiring distance cannot be more than 100m.
- Terminals P1, (+), PB and (-) connect the DC reactor options and parts.
- Use 75°C CU wire only for field input and output wire.

**D.4.3 Cable arrangement**

Motor cables must be arranged away from other cables. The motor cables of several VFDs can be arranged in parallel. It is recommended that you arrange the motor cables, input power cables, and control cables separately in different trays. The output dU/dt of the VFDs may increase electromagnetic interference on other cables. Do not arrange other cables and the motor cables in parallel.

If a control cable and power cable must cross each other, ensure that the angle between them is 90 degrees.

The cable trays must be connected properly and well grounded. Aluminum trays can implement local equipotential.

The following figure shows the cable arrangement distance requirements.

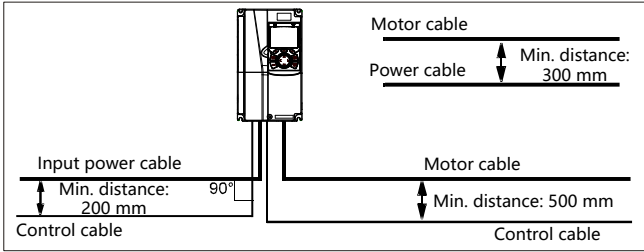

Cable arrangement distances

#### D.4.4 Insulation inspection

Check the motor and the insulation conditions of the motor cable before running the motor.

1. Ensure that the motor cable is connected to the motor, and then remove the motor cable from the U, V, and W output terminals of the VFD.
2. Use a megohmmeter of 500 V DC to measure the insulation resistance between each phase conductor and the protection grounding conductor. For details about the insulation resistance of the motor, see the description provided by the manufacturer.

**Note:** The insulation resistance is reduced if it is damp inside the motor. If it may be damp, you need to dry the motor and then measure the insulation resistance again.

#### D.5 Breaker and electromagnetic contactor

The circuit breaker is mainly used to prevent electric shock accidents and short circuits to the ground that may cause leakage current fire. The electromagnetic contactor is mainly used to control the main circuit power on and off, which can effectively cut off the input power of the VFD in case of system failure to ensure safety.

	<p>According to the working principle and structure of breakers, if the manufacturer's regulation is not followed, hot ionized gases may escape from the breaker enclosure when a short-circuit occurs. To ensure safe use, exercise extra caution when installing and placing the breaker. Follow the manufacturer's instructions.</p>
---	---

Model	Max. prospective line I <sub>sc</sub>	Fuse class type	Fuse current rating
UMI-0007CU-B7	10kA	CC	20A; 600V
UMI-0015CU-B7	10kA	CC	20A; 600V
UMI-0022CU-B7	10kA	CC	20A; 600V
UMI-0040CU-B7	10kA	T	40A; 600V
UMI-0055CU-B7	10kA	T	50A; 600V

Model	Max. prospective line Isc	Fuse class type	Fuse current rating
UMI-0075CU-B7	10kA	T	50A; 600V
UMI-0110CU-B7	10kA	T	90A; 600V
UMI-0150CU-B7	10kA	T	125A; 600V
UMI-0180CU-B7	10kA	T	150A; 600V
UMI-0220CU-B7	10kA	T	150A; 600V
UMI-0300CU-B7	10kA	T	200A; 600V
UMI-0370CU-B7	10kA	T	250A; 600V
UMI-0450CU-B7	10kA	T	250A; 600V
UMI-0550CU-B7	10kA	T	250A; 600V
UMI-0015EU-B7	5kA	CC	20A; 600V
UMI-0022EU-B7	5kA	CC	20A; 600V
UMI-0040EU-B7	5kA	CC	20A/30A; 600V
UMI-0055EU-B7	5kA	CC	30A/40A; 600V
UMI-0075EU-B7	5kA	T	40A/50A; 600V
UMI-0110EU-B7	5kA	T	50A/50A; 600V
UMI-0150EU-B7	5kA	T	50A/80A; 600V
UMI-0180EU-B7	5kA	T	80A/90A; 600V
UMI-0220EU-B7	10kA	T	90A/125A; 600V
UMI-0300EU-B7	10kA	T	125A/150A; 600V
UMI-0370EU-B7	10kA	T	150A/200A; 600V
UMI-0450EU-B7	10kA	T	200A/200A; 600V
UMI-0550EU-B7	10kA	T	200A; 600V
UMI-0750EU-B7	10kA	T	400A; 600V
UMI-0900EU-B7	10kA	T	400A; 600V
UMI-1100EU-B7	10kA	T	400A; 600V
UMI-1320EU-B7	100kA	/	600A; 600V
UMI-1600EU-B7	100kA	/	600A; 600V
UMI-1850EU-B7	100kA	/	600A; 600V
UMI-2000EU-B7	100kA	/	600A; 600V
UMI-2200EU-B7	100kA	/	900A; 600V
UMI-2500EU-B7	100kA	/	900A; 600V
UMI-2800EU-B7	100kA	/	900A; 600V
UMI-3150EU-B7	100kA	/	1500A; 600V
UMI-3500EU-B7	100kA	/	1500A; 600V
UMI-4000EU-B7	100kA	/	1500A; 600V
UMI-5000EU-B7	100kA	/	1500A; 600V
UMI-0007FU-B7	5kA	T	10A; 600V



Model	Max. prospective line Isc	Fuse class type	Fuse current rating
UMI-0015FU-B7	5kA	T	10A; 600V
UMI-0022FU-B7	5kA	T	15A; 600V
UMI-0040FU-B7	5kA	T	15A; 600V
UMI-0055FU-B7	5kA	T	20A; 600V
UMI-0075FU-B7	5kA	T	25A; 600V
UMI-0110FU-B7	5kA	T	30A; 600V
UMI-0150FU-B7	5kA	T	40A; 600V
UMI-0180FU-B7	5kA	T	45A; 600V
UMI-0220FU-B7	5kA	T	100A; 600V
UMI-0300FU-B7	5kA	T	100A; 600V
UMI-0370FU-B7	5kA	T	100A; 600V
UMI-0450FU-B7	10kA	T	250A; 600V
UMI-0550FU-B7	10kA	T	250A; 600V
UMI-0750FU-B7	10kA	T	250A; 600V
UMI-0900FU-B7	10kA	T	250A; 600V
UMI-1100FU-B7	10kA	T	250A; 600V

Integral solid state short circuit protection does not provide branch circuit protection. Branch circuit protection must be provided in accordance with the National Electrical Code and any additional local codes.

## D.6 Reactors

When the voltage of the grid is high, the transient large current that flows into the input power circuit may damage rectifier components. You need to configure an AC reactor on the input side, which can also improve the current adjustment coefficient on the input side.

If the distance between the VFD and the motor is longer than 50m, frequent overcurrent protection may occur to the VFD because of high leakage current caused by parasitic capacitance effects from the long cables to the ground. To avoid the damage of the motor insulation, it is necessary to add reactor compensation.

The VFDs of 220V 18.5–55kW, 460V ( $\geq 37$ kW), and 575 ( $\geq 22$ kW) can be connected to external DC reactor for the improvement of power factors and the avoidance of damage from high input current to the rectifying components because of the high-capacity transformer. The device can also cease the damage to the rectifying components which are caused by supply net voltage transients and harmonic waves of the loads. If the distance between the VFD and motor is longer than 150m, contact Unitronics technical support.

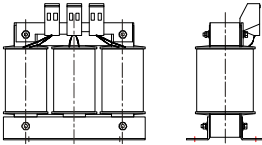

Input reactor

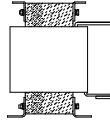
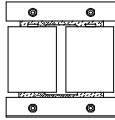
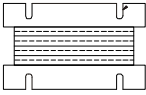

DC reactor

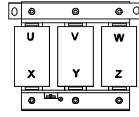
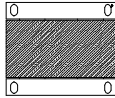

Output reactor

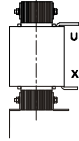

### D.7 Filters

UMI-B7 series VFDs are configured with built-in C3 filters which can be connected by J10.

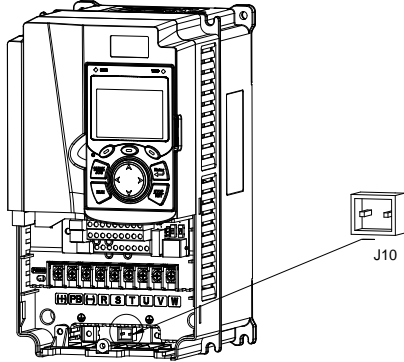

**Note:** Do not connect C3 filters in IT power systems.



Interference filters on the input side can reduce the interference of VFDs (when used) on the surrounding devices.

Noise filters on the output side can decrease the radio noise caused by the cables between VFDs and motors and the leakage current of conducting wires.

### D.8 Brake system

#### D.8.1 Braking component selection

When a VFD driving a high-inertia load decelerates or needs to decelerate abruptly, the motor runs in the power generation state and transmits the load-carrying energy to the DC circuit of the VFD, causing the bus voltage of the VFD to rise. If the bus voltage exceeds a specific value, the VFD reports an overvoltage fault. To prevent this from happening, you need to configure braking components.

	<ul style="list-style-type: none"> <li>◇ The design, installation, commissioning, and operation of the device must be performed by trained and qualified professionals.</li> <li>◇ Follow all the "Warning" instructions during the operation. Otherwise, major physical injuries or property loss may be caused.</li> <li>◇ Only qualified electricians are allowed to perform the wiring. Otherwise, damage to the VFD or braking components may be caused.</li> <li>◇ Read the braking resistor or unit instructions carefully before connecting them to the VFD.</li> <li>◇ Connect braking resistors only to the terminals PB and (+), and braking units only to the terminals (+) and (-). Do not connect them to other terminals. Otherwise, damage to the braking circuit and VFD and fire may be caused.</li> </ul>
	<ul style="list-style-type: none"> <li>◇ Connect the braking components to the VFD according to the wiring diagram. If the wiring is not properly performed, damage to the VFD or other devices may be caused.</li> </ul>

UMI-B7 series VFDs of 220V ≤15kW, 460V≤30kW) need internal braking units and the VFDs 220V ≥18.5kW), 460V (≥37kW) need external braking units. Select the resistance and power of braking resistors according to actual utilization.



The VFDs of 220V ≤15kW, 460V ≤30kW, and 575V ≤18.5kW are equipped with braking units but braking units are optional for the other models. Select braking resistors according to actual operation.

Model	Model of braking unit	Brake resistor at 100% of braking torque (Ω)	Consumed power of braking resistor (kW)			Min. allowable braking resistance (Ω)
			10% braking	50% braking	80% braking	
UMI-0007CU-B7	Embedded braking unit	192	0.11	0.56	0.9	93
UMI-0015CU-B7		96	0.23	1.1	1.8	44
UMI-0022CU-B7		65	0.33	1.7	2.64	44
UMI-0040CU-B7		36	0.6	3	4.8	33
UMI-0055CU-B7		26	0.75	4.13	6.6	25
UMI-0075CU-B7		19	1.13	5.63	9	13
UMI-0110CU-B7		13	1.6	8	12.8	8.8
UMI-0150CU-B7		9.6	2	11	18	6.4
UMI-0180CU-B7	8	3	14	22		
UMI-0220CU-B7	Contact for information	6.5	3	17	26	3.5
UMI-0300CU-B7		4.8	5	23	36	
UMI-0370CU-B7		3.9	6	28	44	
UMI-0450CU-B7		3.2	7	34	54	2.4
UMI-0550CU-B7		2.6	8	41	66	
UMI-0015EU-B7		Embedded braking unit	326	0.23	1.1	1.8
UMI-0022EU-B7	222		0.33	1.7	2.6	130
UMI-0040EU-B7	122		0.6	3	4.8	80
UMI-0055EU-B7	89		0.75	4.1	6.6	60
UMI-0075EU-B7	65		1.1	5.6	9	47
UMI-0110EU-B7	44		1.7	8.3	13.2	31
UMI-0150EU-B7	32		2	11	18	23
UMI-0180EU-B7	27		3	14	22	19
UMI-0220EU-B7	22		3	17	26	17
UMI-0300EU-B7	17		5	23	36	17
UMI-0370EU-B7	Contact for information	13	6	28	44	11.7
UMI-0450EU-B7		10	7	34	54	6.4
UMI-0550EU-B7		8	8	41	66	

Model	Model of braking unit	Brake resistor at 100% of braking torque (Ω)	Consumed power of braking resistor (kW)			Min. allowable braking resistance (Ω)
			10% braking	50% braking	80% braking	
UMI-0750EU-B7		6.5	11	56	90	4.4
UMI-0900EU-B7		5.4	14	68	108	
UMI-1100EU-B7		4.5	14	83	132	
UMI-1320EU-B7		3.7	20	99	158	
UMI-1600EU-B7		3.1	24	120	192	2.2
UMI-1850EU-B7		2.8	28	139	222	
UMI-2000EU-B7		2.5	30	150	240	
UMI-2200EU-B7		2.2	33	165	264	1.8
UMI-2500EU-B7		2.0	38	188	300	
UMI-2800EU-B7		3.6*2	21*2	105*2	168*2	2.2*2
UMI-3150EU-B7		3.2*2	24*2	118*2	189*2	
UMI-3500EU-B7		2.8*2	27*2	132*2	210*2	
UMI-4000EU-B7		2.4*2	30*2	150*2	240*2	
UMI-5000EU-B7		2*2	38*2	186*2	300*2	1.8*2
UMI-0007FU-B7	Embedded braking unit	707	0.2	0.7	1.1	470
UMI-0015FU-B7		464	0.3	1.4	2.2	300
UMI-0022FU-B7		330	0.5	2.0	3.2	220
UMI-0040FU-B7		228	0.9	3.7	5.8	150
UMI-0055FU-B7		165	1.2	5.1	8.0	110
UMI-0075FU-B7		123	1.4	7.5	12.3	82
UMI-0110FU-B7		93	2	11	18	62
UMI-0150FU-B7		70	3	14	22	47
UMI-0180FU-B7		55	4	17	27	36
UMI-0220FU-B7		40.3	5	23	36	10.0
UMI-0300FU-B7	32.7	6	28	44		
UMI-0370FU-B7	26.9	7	34	54		
UMI-0450FU-B7	22.0	8	41	66		
UMI-0550FU-B7	16.1	11	56	90		
UMI-0750FU-B7	13.4	14	68	108		
UMI-0900FU-B7	11.0	17	83	132		
UMI-1100FU-B7	9.2	20	99	158	6.9	

Note:

1. Select braking resistors according to the resistance and power data provided by our company.
2. The braking resistor may increase the braking torque of the VFD. The preceding table describes the resistance and power for 100% braking torque, 10% braking usage, 50% braking usage, and 80% braking usage. You can select the braking system based on the actual operation conditions.
3. When using an external braking unit, set the braking voltage class of the braking unit properly by referring to the manual of the dynamic braking unit. If the voltage class is set incorrectly, the VFD may not run properly.

	⋄ Do not use braking resistors whose resistance is lower than the specified minimum resistance. VFDs do not provide protection against overcurrent caused by resistors with low resistance.
	⋄ In scenarios where braking is frequently implemented, that is, the braking usage is greater than 10%, you need to select a braking resistor with higher power as required by the operation conditions according to the preceding table.

**D.8.2 Braking resistor cable selection**

Braking resistor cables need to be shielded cables.

**D.8.3 Braking resistor installation**

All resistors need to be installed in places with good cooling conditions.

	⋄ The materials near the braking resistor or braking unit must be non-flammable. The surface temperature of the resistor is high. Air flowing from the resistor is of hundreds of degrees Celsius. Prevent any materials from coming into contact with the resistor.
---	--

Installation of braking resistors

	⋄ The VFDs of 220V ≤15kW, 460V ≤30kW, and 575V ≤18.5kW only need external braking resistors.
	⋄ PB and (+) are the wiring terminals of the braking resistors.

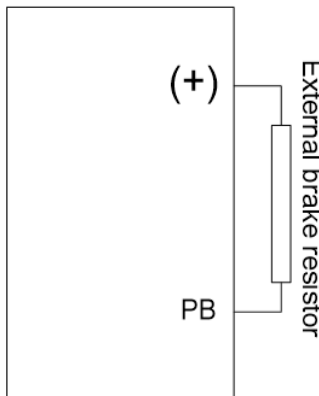

Installation of braking units

	<ul style="list-style-type: none"> <li>◇ The VFDs of 220V <math>\geq</math>18.5kW, 460V <math>\geq</math>37kW, and 575V <math>\geq</math>22kW need external braking units.</li> <li>◇ (+), (-) are the wiring terminals of the braking units.</li> <li>◇ The wiring length between the (+), (-) terminals of the VFD and the (+), (-) terminals of the braking units should be no more than 5m, and the distributing length among BR1 and BR2 and the braking resistor terminals should be no more than 10m.</li> </ul>
---	---

The following figure shows the connection of one VFD to a dynamic braking unit.

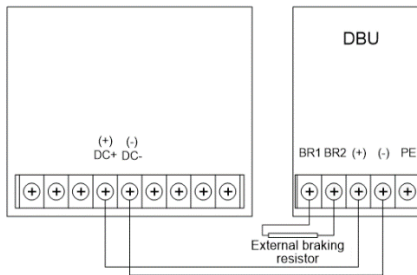

## Appendix E STO function description

Reference standards: IEC 61508-1, IEC 61508-2, IEC 61508-3, IEC 61508-4, IEC 62061, ISO 13849-1, and IEC 61800-5-2

You can enable the safe torque off (STO) function to prevent unexpected startups when the main power supply of the drive is not switched off. The STO function switches off the drive output by turning off the drive signals to prevent unexpected startups of the motor (see the following figure). After the STO function is enabled, you can perform some-time operations (such as non-electrical cleaning in the lathe industry) and maintain the non-electrical components of the device without switching off the drive.

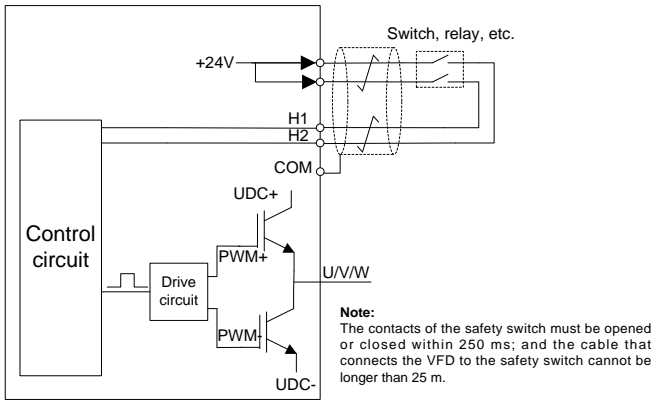

### E.1 STO function logic table

The following table describes the input states and corresponding faults of the STO function.

STO input state	Corresponding fault
H1 and H2 opened simultaneously	The STO function is triggered, and the drive stops running. Fault code: 40: Safe torque off (STO)
H1 and H2 closed simultaneously	The STOP function is not triggered, and the drive runs properly.
One of H1 and H2 opened, and the other closed	The STL1, STL2, or STL3 fault occurs. Fault code: 41: Channel H1 exception (STL1) 42: Channel H2 exception (STL2) 43: Channel H1 and H2 exceptions (STL3)

### E.2 STO channel delay description

The following table describes the trigger and indication delay of the STO channels.



STO mode	STO trigger delay <sup>1</sup> and STO indication delay <sup>2</sup>
STO fault: STL1	Trigger delay < 10 ms Indication delay < 280 ms
STO fault: STL2	Trigger delay < 10 ms Indication delay < 280 ms
STO fault: STL3	Trigger delay < 10 ms Indication delay < 280 ms
STO fault: STO	Trigger delay < 10 ms Indication delay < 100 ms

1. STO trigger delay: Time interval between trigger the STO function and switching off the drive output
2. STO indication delay: Time interval between trigger the STO function and STO output state indication

### E.3 STO function installation checklist

Before installing the STO, check the items described in the following table to ensure that the STO function can be properly used.

	Item
<input type="checkbox"/>	Ensure that the drive can be run or stopped randomly during commissioning.
<input type="checkbox"/>	Stop the drive (if it is running), disconnect the input power supply, and isolate the drive from the power cable through the switch.
<input type="checkbox"/>	Check the STO circuit connection according to the circuit diagram.
<input type="checkbox"/>	Check whether the shielding layer of the STO input cable is connected to the +24 V reference ground COM.
<input type="checkbox"/>	Connect the power supply.
<input type="checkbox"/>	Test the STO function as follows after the motor stops running: <ul style="list-style-type: none"> <li>• If the drive is running, send a stop command to it and wait until the shaft of the motor stops rotating.</li> <li>• Activate the STO circuit and send a start command to the drive. Ensure that the motor does not start.</li> <li>• Deactivate the STO circuit.</li> </ul>
<input type="checkbox"/>	Restart the drive, and check whether the motor is running properly.
<input type="checkbox"/>	Test the STO function as follows when the motor is running: <ul style="list-style-type: none"> <li>• Start the drive. Ensure that the motor is running properly.</li> <li>• Activate the STO circuit.</li> <li>• The drive reports an STO fault (for details, see section 7.5 VFD faults and solutions). Ensure that the motor coasts to stop rotating.</li> <li>• Deactivate the STO circuit.</li> </ul>
<input type="checkbox"/>	Restart the drive, and check whether the motor is running properly.

## Appendix F Acronyms and abbreviations

This chapter describes the acronyms and abbreviations of the terms or words that may be used on the interfaces of the keypad.

Term/word	Acronym/ abbreviation	Term/word	Acronym/ abbreviation
Accumulated/ accumulation	Accum	Interval	Intvl
Address	Addr	Leakage	Lkge
Amplitude	Amp	Lower limit	LowLim
Bridge	Brdg	Low-frequency	LwFreq
Coefficient	Coeff	Low-speed	LwSp
Combination	Comb	Master/slave	M/S
Command	Cmd	Operation/operate/operator	Oper
Communication	Comm	Output	Outp
Compensation	Comp	Parameter	Param
Component	Cmpt	Password	Pwd
Consumption	Consume	Position	Pos
Control	Ctrl	Power	Pwr
Current	Cur	Proportional	Prop
Detection/detect	Det	Protect/protection	Prot
Differential	Diff	Quantity	Qty
Digital	Digi	Reference	Ref
Display	Disp	Resistance	Resis
Dynamic	Dyn	Reverse	REV
Electromotive force	Emf	Saturation	Satur
Emergency	Emer	Short-circuit	S/C
Error	Err	Source	Src
Factor	Fac	Speed	Spd
Feedback	Fdbk	Spindle	Spdl
Filter/filtering	Filt	Switch	Swt
Forward	FWD	System	SYS
Frequency	Freq	Temperature	Temp
Frequency point	FreqPnt	Terminal	Trml
Friction	Fric	Threshold	Thr
High-speed	HiSp	Torque	Trq
Identification/identity	ID	Upper limit	UpLim
Inductance	Ind	Value	Val
Initial	Init	Version	Ver
Input	Inp	Vibration	Vib
Instance	Inst	Voltage	Volt
Integral	Intg	Voltage point	VoltPnt

## Appendix G Energy efficiency data

Table G-1 Power loss and IE class

Model	Relative loss (%)								Standby loss (W)	IE class
	(0;25)	(0;50)	(0;100)	(50;25)	(50;50)	(50;100)	(90;50)	(90;100)		
UMI-0007CU-B7	1.45	1.64	2.45	1.33	1.83	2.22	2.16	2.58	8	IE2
UMI-0015CU-B7	0.71	0.86	1.80	0.79	1.07	1.90	1.61	2.22	8	IE2
UMI-0022CU-B7	1.26	1.42	2.09	1.29	1.62	2.25	1.62	2.49	10	IE2
UMI-0040CU-B7	1.05	1.37	1.59	1.35	1.48	1.98	1.65	2.68	11	IE2
UMI-0055CU-B7	1.20	0.89	2.44	1.35	1.56	2.58	1.64	3.05	10	IE2
UMI-0075CU-B7	0.77	0.94	1.69	0.81	1.18	2.19	1.40	2.16	12	IE2
UMI-0110CU-B7	0.63	1.04	1.66	0.66	1.37	2.41	1.38	2.71	14	IE2
UMI-0150CU-B7	0.55	0.67	1.42	0.64	0.87	1.51	0.95	1.67	14	IE2
UMI-0180CU-B7	0.79	0.89	1.49	1.22	1.60	2.04	1.71	2.35	15	IE2
UMI-0220CU-B7	0.98	1.17	1.73	1.09	1.43	1.90	1.49	2.03	16	IE2
UMI-0300CU-B7	0.79	1.00	1.03	0.80	1.24	1.40	1.31	1.69	21	IE2
UMI-0370CU-B7	0.63	0.89	1.49	0.82	1.28	1.79	1.37	2.01	21	IE2
UMI-0450CU-B7	0.63	0.74	1.38	1.08	1.25	1.79	1.28	1.97	24	IE2
UMI-0550CU-B7	0.56	0.81	1.39	0.73	1.03	1.60	1.09	1.80	25	IE2
UMI-0015EU-B7	1.25	1.22	1.35	0.91	0.84	1.18	0.74	1.18	3	IE2
UMI-0022EU-B7	1.00	1.60	2.01	0.65	0.82	1.23	0.67	1.18	5	IE2
UMI-0040EU-B7	0.92	1.15	1.69	0.93	1.17	1.75	1.16	1.87	6	IE2
UMI-0055EU-B7	0.77	1.04	1.70	0.82	1.13	1.91	1.15	2.14	8	IE2
UMI-0075EU-B7	0.63	0.72	1.28	0.70	0.85	1.85	0.96	1.54	7	IE2
UMI-0110EU-B7	0.49	0.69	1.27	0.50	0.85	1.62	0.81	1.78	9	IE2
UMI-0150EU-B7	0.34	0.42	1.04	0.47	0.60	1.20	0.64	1.37	9	IE2
UMI-0180EU-B7	0.44	0.61	1.00	0.62	0.85	1.40	0.79	1.36	11	IE2
UMI-0220EU-B7	0.38	0.54	1.00	0.55	0.74	1.27	0.71	1.14	11	IE2
UMI-0300EU-B7	0.43	0.58	1.02	0.59	0.74	1.19	0.69	1.23	13	IE2
UMI-0370EU-B7	0.39	0.57	1.14	0.51	0.72	1.32	0.82	1.42	14	IE2
UMI-0450EU-B7	0.40	0.57	1.15	0.64	0.82	1.35	0.80	1.36	21	IE2
UMI-0550EU-B7	0.42	0.56	1.04	0.58	0.73	1.21	0.73	1.15	22	IE2
UMI-0750EU-B7	0.36	0.50	0.92	0.41	0.57	1.06	0.62	1.17	22	IE2
UMI-0900EU-B7	0.34	0.49	0.95	0.39	0.53	1.06	0.74	1.22	25	IE2
UMI-1100EU-B7	0.35	0.51	1.07	0.39	0.61	1.35	0.66	1.47	28	IE2
UMI-1320EU-B7	0.39	0.49	0.87	0.50	0.58	1.05	0.70	1.18	55	IE2
UMI-1600EU-B7	0.48	0.58	1.12	1.00	0.80	1.54	0.82	1.52	55	IE2
UMI-1850EU-B7	0.51	0.63	0.99	0.96	0.92	1.40	0.88	1.33	55	IE2
UMI-2000EU-B7	0.43	0.58	1.16	0.60	0.78	1.49	0.82	1.51	55	IE2

Model	Relative loss (%)								Standby loss (W)	IE class
	(0;25)	(0;50)	(0;100)	(50;25)	(50;50)	(50;100)	(90;50)	(90;100)		
UMI-2200EU-B7	0.44	0.54	0.92	0.62	0.70	1.14	0.77	1.43	80	IE2
UMI-2500EU-B7	0.31	0.49	1.00	0.53	0.76	1.37	0.76	1.43	80	IE2
UMI-2800EU-B7	0.38	0.54	0.92	0.43	0.62	1.13	0.64	1.31	80	IE2
UMI-3150EU-B7	0.36	0.44	0.97	0.40	0.53	1.11	0.53	1.18	80	IE2
UMI-3500EU-B7	0.34	0.47	0.94	0.40	0.48	1.06	0.54	1.21	80	IE2
UMI-4000EU-B7	0.44	0.54	0.99	0.58	0.62	1.18	0.64	1.41	80	IE2
UMI-5000EU-B7	0.35	0.44	0.95	0.39	0.64	1.31	0.75	1.67	80	IE2
UMI-0007FU-B7	1.06	1.26	1.62	1.16	1.42	1.91	1.55	2.02	5	IE2
UMI-0015FU-B7	0.92	1.02	1.55	1.02	1.16	1.72	1.41	1.96	5	IE2
UMI-0022FU-B7	0.80	0.96	1.50	0.92	1.12	1.70	1.30	1.88	5	IE2
UMI-0040FU-B7	0.66	0.82	1.46	0.80	1.06	1.66	1.25	1.86	8	IE2
UMI-0055FU-B7	0.62	0.78	1.43	0.76	1.02	1.60	1.22	1.86	8	IE2
UMI-0075FU-B7	0.56	0.69	1.32	0.72	1.08	1.68	1.26	1.88	8	IE2
UMI-0110FU-B7	0.50	0.64	1.18	0.67	1.06	1.69	1.20	1.86	11	IE2
UMI-0150FU-B7	0.46	0.59	1.14	0.66	1.07	1.64	1.16	1.88	11	IE2
UMI-0180FU-B7	0.45	0.58	1.10	0.65	1.04	1.60	1.13	1.87	11	IE2
UMI-0220FU-B7	0.42	0.56	1.08	0.62	1.00	1.62	1.09	1.89	13	IE2
UMI-0300FU-B7	0.40	0.57	1.06	0.63	0.95	1.62	1.08	1.86	13	IE2
UMI-0370FU-B7	0.40	0.56	1.06	0.64	0.96	1.61	1.04	1.84	13	IE2
UMI-0450FU-B7	0.38	0.58	1.03	0.57	0.94	1.62	1.02	1.90	13	IE2
UMI-0550FU-B7	0.36	0.56	1.04	0.56	0.93	1.53	1.03	1.87	22	IE2
UMI-0750FU-B7	0.34	0.55	1.00	0.54	0.94	1.52	1.02	1.86	22	IE2
UMI-0900FU-B7	0.34	0.54	0.96	0.54	0.95	1.56	1.04	1.81	22	IE2
UMI-1100FU-B7	0.33	0.52	0.98	0.52	0.92	1.54	1.01	1.83	22	IE2

Table G-2 Rated specifications

Model	Apparent power (kVA)	Rated output power (kW)	Rated output current (A)	Max. working temperature (°C)	Rated power frequency (Hz)	Rated power voltage (V)
UMI-0007CU-B7	1.7	0.75	4.5	50°C Derate by 1% for every increase of 1°C when the temperature exceeds 40°C.	50Hz/60Hz, Allowed range: 47–63Hz	3PH 200–240V
UMI-0015CU-B7	2.7	1.5	7			
UMI-0022CU-B7	3.8	2.2	10			
UMI-0040CU-B7	6.1	4.0	16			
UMI-0055CU-B7	7.6	5.5	20			
UMI-0075CU-B7	11.4	7.5	30			
UMI-0110CU-B7	16	11	42			
UMI-0150CU-B7	21	15	55			

Model	Apparent power (kVA)	Rated output power (kW)	Rated output current (A)	Max. working temperature (°C)	Rated power frequency (Hz)	Rated power voltage (V)
UMI-0180CU-B7	26.7	18.5	70			
UMI-0220CU-B7	30.5	22	80			
UMI-0300CU-B7	41.9	30	110			
UMI-0370CU-B7	50.3	37	130			
UMI-0450CU-B7	61	45	160			
UMI-0550CU-B7	76.2	55	200			
UMI-0015EU-B7	2.9	1.5	3.7			
UMI-0022EU-B7	3.9	2.2	5			
UMI-0040EU-B7	7.5	4.0	9.5			
UMI-0055EU-B7	11.1	5.5	14			
UMI-0075EU-B7	14.7	7.5	18.5			
UMI-0110EU-B7	19.9	11	25			
UMI-0150EU-B7	25.5	15	32			
UMI-0180EU-B7	30.2	18.5	38			
UMI-0220EU-B7	35.8	22	45			
UMI-0300EU-B7	47.8	30	60			
UMI-0370EU-B7	59.7	37	75			
UMI-0450EU-B7	73.3	45	92			
UMI-0550EU-B7	91.6	55	115			
UMI-0750EU-B7	119.5	75	150			
UMI-0900EU-B7	143.4	90	180			
UMI-1100EU-B7	171.3	110	215			
UMI-1320EU-B7	207.1	132	260			
UMI-1600EU-B7	243.0	160	305			
UMI-1850EU-B7	270.8	185	340			
UMI-2000EU-B7	302.7	200	380			
UMI-2200EU-B7	338.6	220	425			
UMI-2500EU-B7	382.4	250	480			
UMI-2800EU-B7	422.2	280	530			
UMI-3150EU-B7	478.8	315	600			
UMI-3500EU-B7	517.8	355	650			
UMI-4000EU-B7	573.6	400	720			
UMI-5000EU-B7	685.1	500	860			
UMI-0007FU-B7	1.6	0.75	2.1	50°C	50Hz/60Hz,	3PH
UMI-0015FU-B7	2.7	1.5	3.2	Derate by 1% for every	Allowed range:	520–600V
UMI-0022FU-B7	3.6	2.2	4.5			

3PH  
380–480V

Model	Apparent power (kVA)	Rated output power (kW)	Rated output current (A)	Max. working temperature (°C)	Rated power frequency (Hz)	Rated power voltage (V)
UMI-0040FU-B7	6.2	4	6.5	increase of 1°C when the temperature exceeds 40°C.	47–63Hz	
UMI-0055FU-B7	7.5	5.5	9			
UMI-0075FU-B7	11.1	7.5	12			
UMI-0110FU-B7	16.2	11	16			
UMI-0150FU-B7	21	15	21			
UMI-0180FU-B7	25	18.5	27			
UMI-0220FU-B7	29.2	22	35			
UMI-0300FU-B7	39.6	30	45			
UMI-0370FU-B7	49.4	37	52			
UMI-0450FU-B7	60.6	45	62			
UMI-0550FU-B7	75.2	55	86			
UMI-0750FU-B7	98.6	75	98			
UMI-0900FU-B7	118.2	90	120			
UMI-1100FU-B7	141.1	110	150			